

2024

# Outdoor Play, Fitness and Furniture







**Publisher: KOMPAN A/S**

KOMPAN Group is one of the world's leading manufacturers of outdoor activity areas.

For more than 50 years, the company has designed, manufactured and marketed an extensive range of high-quality playground equipment, outdoor fitness equipment, and outdoor furniture.

KOMPAN® products are sold around the world through KOMPAN subsidiaries, agents and distributors.

Photos: Johannes Zappe, Bernd Gallandi, Highwire/Peter Tammetta, Corocord, and KOMPAN.

All images are for conceptual purposes only.

Installation hours shown under the products are total installation hours, without excavation, for an inexperienced installer.

KOMPAN's general conditions of sales, delivery and assembly can be found on local market websites via [www.kompan.com](http://www.kompan.com)

Errors and omissions excepted.

Copyright 2024 KOMPAN A/S / All rights reserved.



# CONTENT

## About KOMPAN

Creating Healthier and Happier Communities	4
Play the KOMPAN Way	6
Play Value Guaranteed	8
KOMPAN Play and Fitness for All Abilities	10
For a Better Future	12
The Best Solution	18
Highest Quality Materials	20
Warranty	21
KOMPAN Design Studio	22
New Products 2024	26

## BE INSPIRED

KOMPAN Play Solutions	36
-----------------------	----

## THEMED PLAY SYSTEMS

Giants	70
Toddler Multiplay	78
Story Makers™	80
Fairy Tales by H.C. Andersen™	82
Moments™ Castles	84
Moments™ Pirate Ships	86
Moments™ Themed Play	88

## MOMENTS™ Play Systems

Moments™ Mini	90
Moments™ Preschool	96
Moments™ School-age	102
Moments™ Hercules	108

## ELEMENTS™ Play Systems

Elements™ Toddler	118
Elements™ Grow	120
Elements™ Go	122
Elements™ Essentials	126

## Challengers & Climbers

Galaxy™	130
BLOQX™	134

## FREESTANDING PLAY EQUIPMENT

Supernova, Carousels & Spinners	138
Twisting Nets	142

Balancing and Climbing	144
Springers	146
Seesaws	150
Sand & Water Play	152
Themed Play	154
Playhouses and Themed Play	156
Toddler Play Equipment	158
Toddler Stations	162
Play Panels	164
Ziplines	166
Meeting Points	168
Signs	170
Portal Swings	172
Swing Seats	174
Unique Swings	175
Classic Swings	176

## COROCORD™ ROPE PLAYGROUNDS

Corocord™ Sky Play	182
Corocord™ Play Towers	184
Corocord™ Loops	188
Corocord™ Dynamics	194
Corocord™ Slides & Hill Climber Ropes	196
Corocord™ Mini Domes	198
Corocord™ Domes & Arches	200
Corocord™ Spacenet™	206
Corocord™ Monkey Trails Mini	216
Corocord™ Monkey Trails	220
Corocord™ Early Climbing	228
Corocord™ Play Bridges	230
Corocord™ Frame Nets	232

## NATURE PLAY

Robinia Fantasy	238
Robinia Village	242
Robinia Playhouses	250
Robinia Castles	252
Robinia Ships	254
Robinia Themed Play	256
Robinia Accessories	259
Robinia Springers	260
Robinia Dynamics	261
Robinia Ziplines	262
Robinia Obstacle Courses	264
Robinia Balancing	265

Robinia Climbing	266
Robinia Play, Act & Learn	268
Robinia Play Panels	269
Robinia Sand & Water Play	270
Robinia Swings	274

## OUTDOOR FITNESS

KOMPAN Fitness Solutions	280
Cardio	298
Strength	300
Cross Training	302
Cross Training - Compact	304
Street Workout	306
Robinia Street Workout	310
Stay Fit	312
Obstacle Courses	316
Robinia Obstacle Courses	318

## MULTI-SPORT

KOMPAN MUSA Solutions	324
Multi-Use Sports Areas	330
Cosmos Multi-Sport	332

## OUTDOOR FURNITURE

Agora™	338
Agora™ Picnic	340
Rumba™	341
Anita™	342
Chatter™	343
Loop	344
Functional Safe Surfacing	348
Color Options	350
Index	352



**Made Green** means that the products are made of up to 95% post-consumer recycled materials such as ocean waste, used textiles, food packaging waste, used plastic bags, etc. Our Made Green products are made with an approximately 50% reduction in carbon emissions compared to similar traditional products made from virgin sources (depending on the chosen product).



**Born Green** means products are made from natural hardwoods like robinia. Robinia is highly durable and does not require any chemical wood preservatives. KOMPAN Robinia products also come with FSC® certification (C004450)



## SAFETY STANDARDS

Product safety is a long tradition in KOMPAN and we take great pride in testing and evaluating each product before launch.

KOMPAN products meet relevant safety standards depending on the type of product. Playground equipment meets ASTM F1487 and for products intended for users under the age of 2 years, we use ASTM F2373.

Outdoor fitness equipment is compliant with ASTM F3101 and multi-sports equipment meet the European standard EN15312.

Whenever possible, we design worldwide products, meaning the equipment also meets the equivalent European standards and we pick the specifications covering both.



## INCLUSIVE FITNESS

Fitness equipment marked with this symbol can be used by everyone on equal terms independent of gender, age, body weight, fitness, or cognitive skills.



Look for FSC®-certified products on product pages.

The mark of Responsible Forestry.



# CREATING HEALTHIER AND HAPPIER COMMUNITIES

with attractive outdoor playgrounds and fitness sites

A healthy community needs a healthy heart. That heart can be the playground or fitness site, a focal point for meeting, developing, playing, and exercising. It's where strangers become playmates and playmates become friends. It's where adults start conversations, which become life-long bonds. It's where neighborhoods are defined and cities established. Playgrounds and fitness sites bring people together without the boundaries of creed, culture, or age.

## **Local pride, trust, and love**

Playgrounds and fitness sites are places where embarrassment, fear, and unease should melt away in an atmosphere of local pride, trust, and love. It's where children and adults become engrossed in activities that require physical commitment and peer-to-peer communication and in doing so acquire skills and improve their physical fitness – both things that will support them for the rest of their lives. In the fresh air, people get 100% recharged.

At KOMPAN, we value concepts that are universal in design and purpose. It's our starting point regardless of whether it's for a four-year-old rocking on a Crazy Hen, or a sixty-year-old working out on a cross-trainer. Playgrounds and fitness spaces are central to the well-being of a community. Even more so when, side-by-side, children play while adults, young and old, strive for a new level of personal fitness. It's a healthy life in full circle.

## **Access is for all, inclusive play and fitness**

The playgrounds and fitness sites should be the center of a broad community. There are no "exclusive zones" that might isolate or stigmatize. Each playground and fitness

site mirrors the needs of those who use it, whether it's to play, to exercise, or just sit and watch the next generation grow.

That is the KOMPAN view of the perfect way to build a community, healthy in body and mind. A community enjoying a bright today with a brighter tomorrow on the horizon.







↑ ACCESS IS FOR ALL

Fitness spaces are central to the well-being of communities.



← THE CENTER OF A BROAD COMMUNITY

Playgrounds bring people together without the boundaries of creed, culture, or age.





#### ← STAY FACTOR

'Oh no, not yet' is the expression we most love to hear in response to the suggestion to head home. It epitomizes the STAY Factor. Each time a play feature is approached, it should be a fresh encounter, open to new interpretation. The STAY Factor nurtures social interaction, inspiring children of all ages and abilities to stay and play longer.

#### ↓ WOW FACTOR

The eyes wide open to capture the full scene, the mouth forms an O, taking in more air in expectation of action, the legs run wildly in search of adventure. This is the WOW Factor, the moment of arrival at the playground that distinguishes a KOMPAN design from all others. It satisfies the child's instinctive demand for change, variety, and advancement. The constant cry for something new and exciting is only successfully met by triggering that initial WOW.





# PLAY THE KOMPAN WAY

Described in three little words: WOW, STAY, DEVELOP

**WOW** KOMPAN's unique solutions attract more users, make them stay longer, and make them return again and again. Whatever we develop, we develop together with our users. WOW, STAY, DEVELOP, three

distinct factors that are molded into every KOMPAN solution and radiantly displayed in the happy faces of each new generation. Play is the open door to the future.



## ↑ DEVELOP FACTOR

Play isn't just about having fun. Behind the laughter and joy is development: personal, cooperative, and competitive. The DEVELOP Factor is the endless mission of the KOMPAN Play Institute experts. These specialists craft ways of developing motor skills, coordination, and balance. Intellectual learning is equally vital, with cognitive development, communication, language expansion, and understanding of how to turn the germ of an idea into a successful conclusion.



SEE MORE





**1** RECORDING CHILDREN'S OUTDOOR PLAY



**2** SCIENTIFIC AND FOCUSED RESEARCH



**3** FOLLOWING & SHARING KNOWLEDGE



**4** USER WORKSHOPS

**5** TESTING NEW PLAY IDEAS





# PLAY VALUE GUARANTEED

At the KOMPAN Play Institute, we have studied childhood development and children's outdoor play for four decades

Play is vital for child well-being and life skills, be it for a toddler or a teenager. So, KOMPAN playgrounds are carefully designed to motivate all children to play; to play relentlessly again and again, while developing important life skills and also friendships. Children need play stimulation for their physical, cognitive, creative, and social-emotional development. This is why

the WOW-STAY-DEVELOP philosophy is in our DNA and in all our playgrounds.

KOMPAN Play Institute is our driver in this: conducting research, making user workshops, developing and testing with users, and making sure that innovative projects represent the KOMPAN play philosophy.

**1** With action cameras and movement screening, we study what triggers children to play, and to continue playing. We learn what makes children play, move, talk, and cooperate. This informs our product design to stimulate the social-emotional skills, language, and communication.

**2** Science and universities are a major source of our fundamental research and knowledge. We cooperate with universities and draw on this in all product development. The collaboration takes several forms, such as joint industry PhD students.

**3** To constantly stay on top of new research, KOMPAN Play Institute participates in conferences, building networks to share and gain insight and knowledge.

**4** Children are the experts in what motivates them to play and what they like to play. Their preferences develop with age and with cultural changes. We conduct workshops where children share their ideas on playgrounds and give us feedback on our newest ideas.

**5** Prototypes are tested at their earliest stages in order to prove and perhaps improve relevance. This helps fine-tune important basics, like the placing of components and creating interaction in teamwork.

**6** When children play in their outdoor setting and on their terms, they use play features differently from a laboratory setting. We install prototypes in kindergartens and schools to ensure that the children truly get the benefit we intended and that they deserve.

## 6 PROTOTYPES IN THEIR NATURAL HABITAT





# KOMPAN PLAY AND FITNESS FOR ALL AB

KOMPAN Play Institute and KOMPAN Fitness Institute work on science-based, user-test informed equipment, and design recommendations

We humans need play and exercise for our health and well-being. Play is a human right for children and closely connected to their well-being and positive development. At KOMPAN, we encourage all children to experience and enjoy the physical, social-emotional, and creative learning benefits of playgrounds.

Inclusive play and fitness are at the very core of everything KOMPAN aims for. The result is universal design that embraces the needs of all. In inclusive universal play-

grounds and fitness sites, everyone can play or exercise with peers, with parents, in groups, or individually, regardless of their abilities or disabilities.

This design philosophy is acted out in KOMPAN's playgrounds and play equipment as well as in our fitness grounds and fitness equipment. Everyone can take something positive out of a visit to a KOMPAN play and fitness site. Health, like play and well-being, is for everyone.

## Fitness areas for all:

Principles for inclusive outdoor fitness:

- Accessibility
- Ease of use
- Adjustability
- Products having clear color and design signals
- Multi-functionality (when possible)
- Combining general and specific functionality

USABLE FOR ALL →

The multi-level activities of the fitness products make them usable for all.

Read more and download on  
[www.kompan.com](http://www.kompan.com)





# ILITIES

## UNIVERSAL DESIGN

The ergonomic and user-tested design of the seat ensures usability for persons with mobility disabilities. The upright seat position allows for an overview of the playground along with eye contact and communication with the person pushing the swing. The harness system provides security for all users.



Of course, as individuals, we all have limits. Inclusive playgrounds and fitness areas cater to that and offer playful and inclusive ways to reach and pass those limits and perhaps reset the bar, to advance and grow.

Download the white papers on inclusive design research and recommendations for playgrounds and fitness grounds from our webpage: [www.kompan.com](http://www.kompan.com)



## Playgrounds for all:

Accessible, inclusive, and usable in play:

- Is it developed with users?
- Is it spacious and can it accommodate different body positions, sizes, and abilities?
- Is it thrilling, challenging, and pleasurable?
- Is it rich in play variation: Sensory, physical, social-emotional, cognitive-creative?
- Is it transparent and has a 360-degree design: Play all around?



### ↑ RICH IN PLAY VARIATION

Sensory, physical, cognitive-creative, and social-emotional stimuli.



### ↑ MULTI-FUNCTIONAL

Spacious and supportive of different body sizes, positions, and abilities.



Read more and download on [www.kompan.com](http://www.kompan.com)



SEE MORE



# Join our green journey!

Making the future's playgrounds carbon neutral



More than 80% of our carbon emissions from building playgrounds come from the raw materials. Therefore, all raw materials that can be replaced with post-consumer recycled waste sources have been replaced. From January 2024, our playgrounds will be made from components with up to 95% post-consumer recycled waste sources.

## No need to choose green – we have chosen it for you

Using post-consumer recycled waste sources has been integrated into the core of our business. No matter what playground product you choose, it will have a greener profile, with components containing up to 95% post-consumer recycled waste. Before, virgin materials like plastic took up most of the space, but now the roles are reversed, putting waste sources in the lead.

Together we can lower carbon emissions and secure a playful future for our children.



Made Green means that products are made of up to 95% post-consumer recycled materials such as ocean waste, used textiles, food packaging waste, used plastic bags, etc. Our Made Green products are made with an approximately 50% reduction in carbon emissions compared to similar traditional products made from virgin sources (depending on the chosen product).



Born Green means products are made from natural hardwoods like robinia. Robinia is highly durable and does not require any chemical wood preservatives. KOMPAN Robinia products also come with FSC® certification (C004450).





**-74%\***  
CO<sub>2</sub>e/kg

Using TexMade™ posts made from >95% post-consumer recycled textile and plastic waste instead of steel posts reduces carbon emissions by 74% CO<sub>2</sub>e/kg when comparing 1m steel post (2mm pipe thickness) to 1m TexMade™ post.

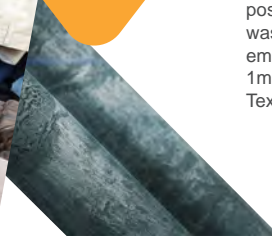

Using EcoCore™ HDPE panels made from >95% post-consumer ocean recycled waste instead of panels made from virgin plastic reduces carbon emissions by 82% CO<sub>2</sub>e/kg

Using BLOQX™ panels made from 75% post-consumer ocean recycled waste instead of virgin plastic reduces carbon emissions by 68% CO<sub>2</sub>e/kg on the panels.

**-82%\***  
CO<sub>2</sub>e/kg

**-68%\***  
CO<sub>2</sub>e/kg

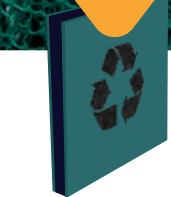

**-82%\***  
CO<sub>2</sub>e/kg

Using EcoCore™ HDPE panels made from >95% post-consumer recycled waste instead of panels made from virgin plastic reduces carbon emissions by 82% CO<sub>2</sub>e/kg



**-68%\***  
CO<sub>2</sub>e/kg

Using BLOQX™ panels made from 75% post-consumer recycled waste instead of using virgin plastic reduces carbon emissions by 68% CO<sub>2</sub>e/kg on the panels.

**-30%\***  
CO<sub>2</sub>e/kg on avg.

Using Hercules Rope Yarn made from >95% post-consumer recycled waste reduces carbon emissions by 30% on average.



**-56%\***  
CO<sub>2</sub>e/kg

Using low-carbon aluminum profiles produced with renewable energy sources, instead of using aluminum profiles made with traditional energy sources, reduces carbon emissions by 56% CO<sub>2</sub>e/kg.

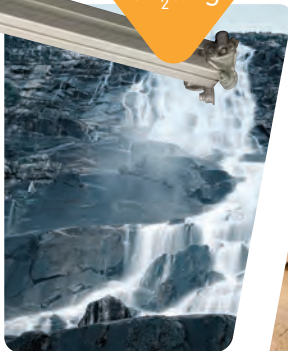

Using nature's materials, such as robinia and pine wood from responsible forestry, where wood is bred for harvesting and both planting and harvesting are carefully controlled, results in highly durable playgrounds and fitness sites.

\* All figures compare kg CO<sub>2</sub>e/kg.





↑ BORN GREEN

materials are made from natural hardwoods like robinia. Robinia is highly durable and does not require any chemical wood preservatives. KOMPAN Robinia products also come with FSC® certification (C004450).

**Complete transparency**

Green data is available for all our products, for comparison of carbon emissions.

Cradle to Gate A1-A3	Total CO <sub>2</sub> emission kg CO <sub>2</sub> e/kg	CO <sub>2</sub> eq/kg	Recycled materials %
PC0228101-0901	2.162,50	2,62	50,25
PC0228101-0910	1.756,00	1,92	64,60

Validation of CO<sub>2</sub> calculation

BUREAU VERITAS  
HSE Denmark A/S

# Validated CO<sub>2</sub>e calculations

For many years, we at KOMPAN have been working with sustainability and environmental concerns in our product development and we do not take shortcuts in our approach to this incredibly important aspect of design:

- We work with Bureau Veritas who validates our method for calculating carbon footprints.
- We enable customers to choose lower carbon emissions by choosing products that are either Made Green or Born Green.

We make carbon footprint data available for all standard products for comparison of carbon emissions data – Made Green or Born Green products versus traditional products.





JANUS 2021  
DE LA CITÉ



GOOD  
DESIGN  
AWARD  
WINNER

# Made from raw materials with lower carbon emissions

Made Green from post-consumer waste or Born Green from nature

## TEXMADE™

posts are made from >95% post-consumer recycled textile and plastic waste – Made Green



## OCEAN GREEN PANELS

in the color Teal are made from >95% post-consumer ocean recycled waste collected from the maritime industry such as fishing nets, ropes, and trawl nets – Made Green

## BLOQX™ CLIMBING PANELS

are made from 75% post-consumer recycled waste from household waste and the Teal color version is made from ocean recycled waste only – Made Green



## ROBINIA PRODUCTS

are made of robinia wood from primarily FSC®-certified (C004450) forestry that develops so much oil when growing that it is self-sustaining and very long-lasting – Born Green

## COLORED PANELS

in EcoCore™ HDPE are made from >95% post-consumer recycled waste, including the colored cap layer – Made Green



## DECKS

are made from 75% post-consumer recycled waste – Made Green

## EXTRUDED ALUMINUM

profiles are made using low-carbon aluminum – Made Green

## COLORED ROTOMOLDED COMPONENTS

used for Supernova, Spinner Bowl, Tipi Carousel, etc. and made from 33% post-consumer recycled waste from household waste. The Teal color version is made from ocean recycled waste only – Made Green

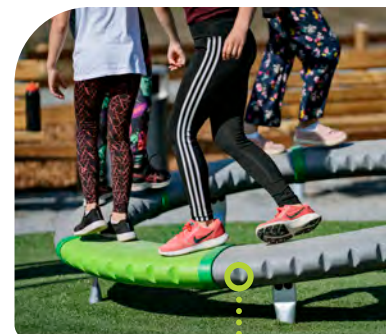



# Let's play green

KOMPAN playground solution made from 69% recycled materials



RECYCLED: 45%  
Product number: GXY916

RECYCLED: 61%  
Product number: BLX4105

RECYCLED: 79%  
Product number: PCM003421



RECYCLED: 48%  
Product number: M101

RECYCLED: 73%  
Product number: PCM301331

RECYCLED: 82%  
Product number: KSW90014



RECYCLED: 50%  
Product number: PAR4150

RECYCLED: 82%  
Product number: PCM000121

RECYCLED: 77%  
Product number: MSC5414

See more solutions  
on [kompan.com](http://kompan.com)

Minor regional deviations can occur due to differences in safety standards



# THE BEST SOLUTION

Outstanding performance on all parameters



## Most green

The use of post-consumer recycled waste sources has been integrated into the core of our business. No matter what traditional playground product you choose, it will have a greener profile, with components containing up to 95% post-consumer recycled waste. Read more about this on pages 12-17.



Read more  
and see video



## Most beautiful and timeless play and fitness designs

KOMPAN was born out of art. Half a century ago, sculptor Tom Lindhardt observed children playing on his artistic creations. Tom turned the process full circle to allow playgrounds to become beautiful and timeless, like art objects. In the succeeding years, the little Homo Ludens figure, the KOMPAN symbol, has become the iconic mark of inventive quality, the logo that says, 'this is the art of playing.'



## Most playful and developing play designs

Children are like snowflakes, externally similar yet singularly different. With KOMPAN design, the diverse elements demanded by children, the thrills of speed, height, space, and the importance of role-play and comradeship, are built into every module. The playgrounds themselves are like snowflakes, clearly recognizable but always different. Our aim is threefold: to create a WOW reaction that stimulates a desire to STAY and, through play physically and mentally, DEVELOP. Read more about this on pages 6-7.



## Outdoor fitness that actually makes an impact

Exercise and fresh air, natural partners, and the universal formula for feeling good. Today we are aware of the positive results of physical exertion. Our 21st-century lifestyles demand it, but to get it right takes a scientific approach to what to do, how to do it, and what to do it on. This is where design meets reality. We collaborate with sports physiologists and physiotherapists as well as universities and sports researchers to make sure we deliver perfect and impactful outdoor equipment.

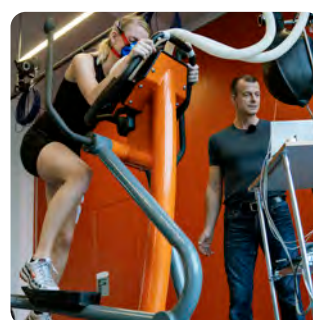





### Tailor-made solutions

We know that our customers are different and want something different from their playground or fitness space: aesthetics, themes, age groups, number of children to be able to play at the same time, etc. A theme park may want to make a WOW playground in order to attract children. A school may want a very physical playground where children can burn energy in order to concentrate better during lessons. So our architects, landscape architects, and designers tailor solutions for you, your users, your environments, and your wants.



### Most unique play landmarks by KOMPAN Design Studio

When is a playground not just a playground? When it is one of a kind. KOMPAN's Design Studio creates built-from-scratch playgrounds and fitness areas that are tailored to say something about the community they serve. They are landmarks, as distinctive as a gift of nature, or an architectural gem. From USA to France, from Germany to Singapore, these are unique statements from communities wishing to stand out, ready to make their mark.



### Inclusive, universal design for play and fitness

In KOMPAN playgrounds and fitness sites, everyone should feel included. Regardless of their physical or mental ability, play and fitness are for everyone. The human need for play, physical activity, and social interaction across abilities is what we plan for. We build facilities that aren't merely accessible, but are intentionally inclusive and usable by all to the greatest possible extent. Universal inclusive design means a stigma-free playground for everyone. Read more about this on pages 10-11.



### Your preferred partner from idea to play can begin

Building a playground may sound as easy as playing, but can be a very complex and complicated process. We are ready to take the burden off your shoulders and be your partner in the process. We help you find the best products and best layout for you, your users, and your site. We make sure that the new site is a safe and a lovely place to spend hours and hours. We make sure that everything gets to site on time, clearing the site, digging foundations, installing products, installing the safety surfacing, and building paths, fences, benches, etc.

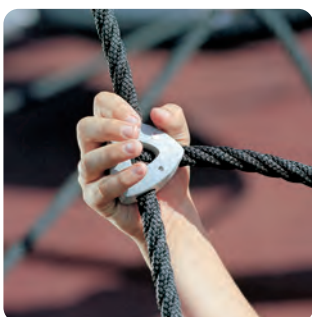

### THE HIGHEST QUALITY

Playgrounds have to stand the wear and tear of weather and heavy usage. A KOMPAN site is made from the highest quality materials that require less maintenance allowing the equipment to stand the test of time and look inviting for decades to come. This way, users get as many hours of joy as possible. Read more about this on pages 20-21.



Read more

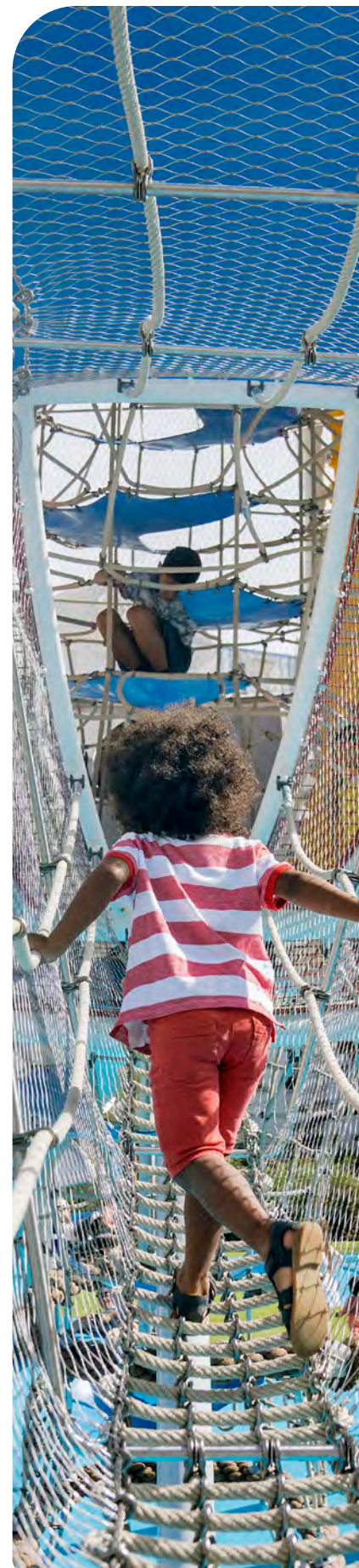



# HIGHEST QUALITY MATERIALS

Built to last

All playgrounds face the trials of weather, use and abuse, and will eventually succumb to the ravages of time. That day can be postponed by using the finest of mate-

rials and clever designs. Quality costs, but quality also lasts. A simple equation that in the fullness of time, pays dividends.



## PLAY PANELS

The 19mm EcoCore™ panels are a highly durable and eco-friendly material, which is not only recyclable after use, but also are made from >95% post-consumer recycled waste.

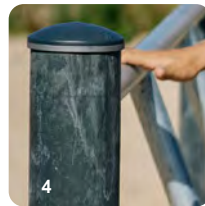

## POSTS

Main posts are available in four different materials.

1. Impregnated pine wood with in-ground steel footing.
2. Galvanized steel with powder-coated top finish.
3. Color-anodized, lead-free aluminum, made from low-carbon aluminum.
4. TexMade™ posts made from >95% post-consumer recycled textile and plastic waste.



## DECKS

All decks are supported by uniquely designed low-carbon aluminum profiles with multiple attachment options. The gray-colored molded decks are made of 75% post-consumer PP material with a non-skid pattern and texture surface.



## GALVANIZED STEEL

Our steel surfaces and steel frames consist of a hot-dip galvanized inside and outside with lead-free zinc according to global safety standards for playground equipment. The galvanization has excellent corrosion resistance in outside environments and is maintenance free.



## HERCULES ROPE

Ropes come with galvanized six-stranded steel wires and a steel core, impossible to wear through. Each strand is tightly wrapped with PES yarn in >95% post-consumer recycled material, which is melted onto each individual strand, making the ropes highly wear and vandalism-resistant.

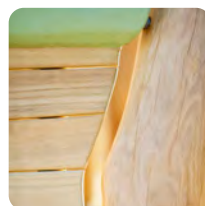

## ROBINIA WOOD

Robinia wood is a very strong and long-lasting material with very high levels of natural oils. Thus Robinia wood makes durable playgrounds almost maintenance free able to last for many years.





# WARRANTY

We have industry-leading warranties



## LIFETIME\* Warranty

- Hot-Dip galvanized parts
- Stainless steel parts
- EcoCore™ and other high-density polyethylene (HDPE) parts



## 15-year warranty

- High-pressure laminate (HPL) parts
- Aluminum parts



## 10-year warranty

- TexMade™ posts
- Pre-galvanized posts with painted top layer
- Painted surface on galvanized or aluminum metal parts
- Stainless Steel Slides
- Electrogalvanized metal parts
- Molded PP decks
- Solid plastic parts
- Hollow plastic parts
- Transparent Poly Carbonate (PC) parts
- Rope and net constructions
- Wood-plastic composite (WPC) parts
- Robinia, ash, pine, and other wood types



## 5-year warranty

- Resin coated plywood parts
- Springs and ball bearing assemblies
- Graphic print on transparent PC panels
- Concrete parts
- Galaxy Connection Balls

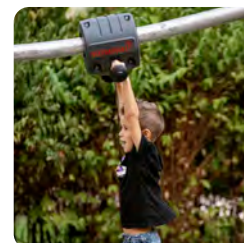

## 2-year warranty

- Moveable plastic and metal parts
- Rubber membranes
- Screens and electronic parts
- Sunshades & sail solutions
- Nylon nets
- Spare parts

\* KOMPAN's LIFETIME warranty is in effect for the lifetime of the product until the product is uninstalled and/or taken out of use. In addition, KOMPAN's general terms and delivery conditions apply and supplement this warranty.

## WARRANTY COVERAGE

This warranty applies to KOMPAN's products for the time periods described for each product type above and with the limitations described in this warranty. The warranty period applies from the date of purchase by the first customer. This warranty covers only defects in materials, production errors, and structural integrity failures caused by defects in design, materials, or manufacturing. KOMPAN's liability under this warranty is limited to repair or replacement of defective products, without charge, at KOMPAN's discretion.

## PROPER INSTALLATION AND MAINTENANCE

The warranty only applies if KOMPAN's products have been installed according to the instructions provided by KOMPAN and maintained correctly according to the KOMPAN Maintenance Manual. All warranty claims shall be accompanied by full documentation for proper installation and maintenance.

## WARRANTY EXCLUSIONS

This warranty does not cover any damage caused by accident, improper care, negligence, normal wear and tear, surface corrosion on metal parts, discolored surfaces, and other cosmetic issues or failures due to misuse or vandalism. Natural changes in wood over time are considered cosmetic issues and are not covered.

## NEAR WATER INSTALLATIONS

Products installed in direct contact with chlorinated water or saltwater (water-parks), or products installed within 650 feet from the shore are not covered by the KOMPAN warranty for any defects caused by corrosion. Specially designed products (handled via department for customized products), provided they have been upgraded to corrosion class C4 prior to delivery, installed within 650 feet from the shore (and not in direct contact with saltwater/spray of saltwater or chlorinated water(e.g. waterparks)) shall, subject to the applicable warranty period for each product type set out in the general warranty, be covered only against structural failure caused by corrosion (excluding moving parts) and under no circumstances for any period longer than 5 years.

## THIRD-PARTY SUPPLIED PRODUCTS AND SERVICES

KOMPAN provides non-KOMPAN branded products and installation services performed by certified third-party suppliers. This general KOMPAN warranty does not apply to such non-KOMPAN branded products and installation services, which may carry their own warranties. KOMPAN will pass on information on such warranties where possible.

## FREIGHT AND WAREHOUSING

Global transport and logistics arranged by Kompan appointed forwarder. Products/items are not to be stored outside waiting for installation and must be kept dry at all times.

## SAFETY STANDARDS

*'In the interest of playground safety, the International Play Equipment Manufacturers Association (IPEMA) provides a Third Party Certification Service whereby a designated independent laboratory, TÜV SÜD America Inc., (TÜV), validates an equipment manufacturer's certification of conformance to the ASTM F1487 Standard Consumer Safety Performance Specification for Playground Equipment for Public Use, except sections 7.1.1, 10, 13.1.1, 13.1.2, 13.2, and 13.3; to CAN/CSA Z614 Children's Playspaces and Equipment, except clauses 10 and 11; or both. A list of current validated products and components may be viewed at [www.ipema.org](http://www.ipema.org).'*

Visit [www.ipema.org](http://www.ipema.org) to learn if products are IPEMA-certified.



SEE MORE





↑ THE LOG CABIN RESTAURANT

Penrith, New South Wales, Australia



↑ DINO PARK NIRIMBA

Sunshine Coast, Queensland, Australia



↑ SCHOOLEY MILL PARK PLAYGROUND

Maryland, USA

# MAKE YOUR SPECIAL PLACE COME TRUE

KOMPAN Design Studio designs and constructs unique landmark playgrounds

Across the world, communities and companies want to create landmark locations that bring children, adults, and communities together and function as great destinations for visitors.

At KOMPAN Design Studio, we understand that our focus on WOW, STAY, and DEVELOP is essential when designing and building landmark playgrounds.

The location must be beautiful; but it must also be fun and challenging. Utilizing our

special architectural and engineering experience and skills at KOMPAN Design Studio and combining this with our KOMPAN Play Institute competencies, we create the most attractive and fun landmark and destination playgrounds. Playgrounds that children and adults want to stay at, come back to – again and again – and talk about as great destinations to visit.



# TAILOR-MADE

## Understanding your dream

A school may want a play sculpture that symbolizes wisdom and learning. A local community may want their play

sculpture to tell a story about the community, connecting one generation to the next.



### 1 FINDING THE PERFECT CONCEPT

Together we find the perfect concept for your story. For example, we can conceptualize a train station for a station town or a municipality that wants to signal something with train transportation.



### 2 RESEARCHING THE CONCEPT

Next, the design team will study the phenomena in order to find the features that visualize your story the right way. For train transportation, a freight train could be key.

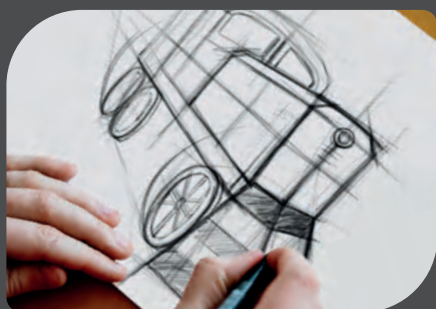

### 3 SKETCHING DESIGN IDEAS

The first sketches are made and delivered to you in order to test ideas and find the perfect design for you.



### 4 LOADED WITH PLAY

Your play sculpture is loaded with the portfolio of play features that we have invented throughout half a century.

### 5 BUILDING THE PLAY SCULPTURE

Our engineers make sure that the static structure is safe and sound. We use the highest quality materials in order to build a landmark that lasts for decades.

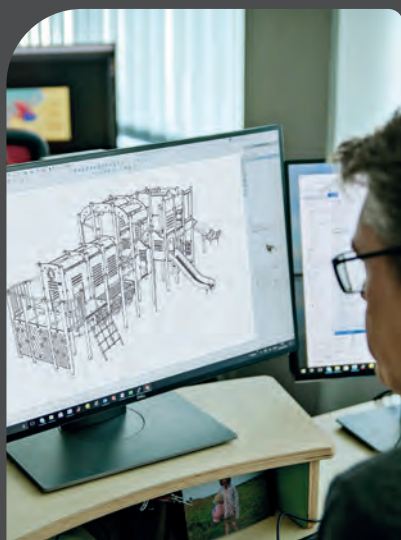

### 6 THE FINAL PLAY STRUCTURE

Based on the initial idea, created by skilled designers, engineers and craftsmen, the final play structure is now ready for children to come and play at for hours and hours.





# KOMPAN DESIGN STUDIO

Turning themes, ideas, and stories into play landmarks

For more than a decade, we have built tailor-made and highly unique destination playgrounds that WOW, inviting children and adults to come and play. They come in all kinds of themes and can be customized to your local community, or to fit a specific environment. Always loaded with the play activities we have developed over half a century.

The structures are made of highly durable and vandalism-resistant materials that make them last for decades to come. Also, they are safe and certifiable like all products that we have built over the past 50 years.



↑ SOLÉ MIA COMMUNITY  
North Miami Beach, Florida, USA



↑ ROTARY PARK  
Ingham, Queensland, Australia

ROSE DES VENTS GARDEN →  
Puteaux, France







**NEW**

**ROBINIA FANTASY** See page 238

### Shaped by nature

Each Robinia Fantasy structure has its unique appearance. Natural variations will also occur.



### Charmed Colors

All play structures are available with an enchanting color palette in muted green hues.



# ESCAPE TO THE FOREST OF FANTASY

Welcome to the enchanting universe of Robinia Fantasy

These fantasy-themed play structures bring the forest closer to the playground in the name of play and imagination. The Robinia Fantasy universe is designed to spark children's imagination and encourage them to engage with the organic order of nature.

The quirky expression of the play structures is unique and entirely on nature's

terms, and this creates a lasting attraction for children and adults alike. The signature posts have a wonderful authentic wood grain pattern from when they were forested in their natural state.

Packed with play value, children of all abilities at any age are in for an intriguing adventure as they explore the magical world of Robinia Fantasy.



## DECK-TO-DECK ACCESSIBILITY

The structure can be entered via wooden ladders or from the deck-to-deck entrance, enabling access for varying ages and abilities.



## ↑ TRIPLE THE FUN FOR THE LITTLE ONES

The double-sided play panel's interactive qualities encourage parents, caregivers, and little friends to join the play and create shared memories.



## ↑ SIGNATURE POSTS AND ROOFS

The rustic posts, crooked roof, and overall organic aesthetic embrace and enhance the fantasy theme.





↑ **STEPPING STONES**

Embarking on a large play structure can tire little legs. Small platforms along the trail enable a rest to gather strength and work as a stepping stone to the next play hurdle.



↑ **WAVE STEPPER**

Expand ground-level play with interconnecting add-on playground equipment. The Wave Stepper offers gentle bouncy movements that train balance and give an understanding of cause-and-effect.

↑ **PLAY FOR THE ENTIRE PRE-SCHOOL AGE GROUP**

Whether three or six-years-old, the thrill of taking steps into the unknown creates a sense of achievement. Age appropriate challenges are integrated into the play structure, meaning the Monkey Trails Mini will continue to grow with the children as they develop.

# EXPLORE THE TRAIL OF PLAY

Trailblazing climb-and-crawl structures for the youngest

As young children approach the Monkey Trails Mini, their eyes widen in awe of its vibrant design. They are instantly drawn to the bright colors and familiar themed-play shapes that ignite their curiosity. Bouncing surfaces, rope play, and explorative features create response and wonder, which are great play motivators.

Children who experience playgrounds with manageable, age-appropriate, and fun play events gain essential social-emotional life skills and develop fundamental motor skills. Ground-level hurdles, tunnel logs, and play panels entice children to play again and again.





# A MINI DOME OF AWE

Enter a world of climb-and-crawl for little explorers

The Mini Dome is a wondrous climb-and-crawl structure designed for little explorers. With pleasantly swaying rest points, gently bouncing climbs, and intriguing play panels, this downsized dome structure is big on play value for two to five-year-olds. Play is accessible from all sides and the structure's transparency ensures a sense

of security when children crawl and climb to the top. Parents and caregivers are always close by. At ground level, they can play hide-and-seek or peek-a-boo beneath the structure and the abacus and mirror play panel ensure hours of exploration, developmental learning, and play.



## ↑ PLAY SHELL CLIMBERS

The Play Shell Climber is a multifunctional, free-standing climbing and hang-out module where children can retreat and pause.



## ↑ CLIMBING IS IMPORTANT

Especially in the early years, climbing is an essential skill for a child to master. Climbing develops cross-coordination skills, stimulating the child's brain and helping them learn how to read.



## ← COLOR OPTIONS AND FLEXIBILITY

The new Monkey Trails Mini structure is available in three vibrant standard colors – red, blue, and green – and offers exchangeable activities that expand the trail and challenges. You can also combine the Mini Dome and Monkey Trails Mini into one amazing play structure.



**NEW**

**ROCKET ROLLER** See page 139





# NEED A NEW PLAYGROUND BOOSTER?

The Rocket Roller is great for activating under-utilized play spaces

**■** The enticing shape of the Rocket Roller has a supreme skill in capturing playful children. The inclination allows children to control the rotation speed with pushing and pulling motions, challenging their

proprioception and spatial awareness. The Rocket Roller is all about finding the center of gravity, togetherness, and the need for speed.

## 3, 2, 1, LIFT-OFF →

The Rocket Roller is the perfect way to activate under-utilized spaces in your school, the park, or recreational areas. Whether having fun alone or with friends, the Rocket Roller is such a blast.

## ← AIM FOR THE STARS

Freestanding playground equipment allows you to add a unique flavor to smaller play spaces or freshen up a public playground area at a relatively small cost. They are great as stand-alone play features and offer great flexibility and versatility in the playground layout.







↑ TRACTOR FUN

The all-wooden tractor cabin frame holds lots of play activities. Climb through the rear wheels, hide in the engine hood, or use the rear slide to unload hay bales.



← READY FOR TAKE-OFF

Nothing beats flying, unless it's flying with your favorite co-pilot.

# INSPIRE REAL-LIFE ROLE-PLAYING

Make playtime educational as well as fun with transportation-themed playground equipment in robinia wood.

Our new transportation-themed play structures tickle the imaginations of children. Including airplanes, a tractor, and other types of vehicles in your playground allows children to imagine themselves in real-life situations. Pretending to be a farmer or a pilot ignites their creativity and ability to embrace their surroundings.

Engaging in this type of role-playing develops their language and social-emotional skills and encourages and provides hours of stimulating and adventurous play.



# A BOUNDLESS CLIMB

Feel the thrills and vibrations of the Nimbus Cloud

Like a ground-level nimbus cloud, this amazing net-climbing sculpture hovers intriguingly, attracting children and adults alike. The softly bouncing Coromesh spurs cautious walks and crawls on the outside and wild climbs on the inside. Whether

embarking on a thrilling play journey from an easy access point in the middle of the sculpture, or a more challenging climb from the outside, children will feel like they are bouncing in the sky.



**↑ HAVE A HOVERING BREAK**

On the way to the hang-out spot at the top, children can pause on swaying triangle plates dispersed in the net.



**↑ CHALLENGING ACCESS OPPORTUNITIES**

Get ready to enter the climbing structure via vertical ropes with climbing discs or steep nets. The Nimbus Cloud offers lots of challenging climbs at all levels.



**↑ A BURST OF COLOR**

Hang out, relax, and sway at ground level before embarking on the colorful urban jungle nets. Nothing softens a concrete jungle like a vibrant, colorful climbing structure.









# BE INSPIRED

The following pages provide inspiration on how to plan a playground with play activities, intergenerational play, age-appropriate play, and play zones.



# CAMPING ADVENTURE



## PLAY SOLUTION

While parents set up the camper, children can laugh with excitement as they enjoy the playground! Children can meet new friends at the campground as they play on the many options for spinning, bouncing, and swinging.

This is a playground that's sure to attract children to come and play, hang out, and have fun.

**Let's play**





See more solutions  
on [kompan.com](https://www.kompan.com)

Minor regional deviations can occur due to differences in safety standards

## PRODUCT INFORMATION

Product number	Product name
1 CRP250802	Mountain Trail
2 KSW922	Swing Frame, 2 Seat, 8 ft H
3 GXY959	Spinner Disc
4 ELE400067	Springer Bowl with Footrest
5 PCM161	Turbo Carousel
6 PCM111531	Track Ride Tower
7 PCM81331	Penta Climber
8 PAR4170	Agora Picnic Table Set

Let's  
play



# INCLUSIVE FOR ALL



## PLAY SOLUTION

The amazing, thrilling playscape attracts all ages and abilities with its richly varied, responsive play choice. The varied playground areas support both wild and quiet play types and behaviors for young as well as older children and teens.

Several playground zones with break areas invite long stays. KOMPAN's six universal design principles guide a playscape, inspiring children of all abilities to play and come back.

**Let's play**





See more solutions  
on [kompan.com](http://kompan.com)

Minor regional deviations can occur due to differences in safety standards

## PRODUCT INFORMATION

Product number	Product name	Product number	Product name
1	<b>COR71150</b> Embankment Slide Extra wide, 5 ft	10	<b>PCT802</b> FunPoint, Ultimate
2	<b>COR10545</b> Hill Climber Rope with EPDM	11	<b>PCM003221</b> Play Panel 2 - Emotion, Classic
3	<b>GXY959</b> Spinner Disc	12	<b>M186</b> Garden Seesaw
4	<b>ELE400024</b> Spinner Bowl	13	<b>PCM103031</b> Play Tower with Ramp
5	<b>ELE400067</b> Springer Bowl with Footrest	14	<b>PCM157</b> Universal Carousel
6	<b>ELE400065</b> Tipi Carousel w/ Top Brace	15	<b>KSW92009</b> Swing, 3 seat, 8 ft H, 1 Shell Seat
7	<b>COR20330</b> Inclusive Twister	16	<b>SW990205</b> Inclusive Seat, 8 ft H, 2-Chain
8	<b>CRP812001</b> Sensory Dome	17	<b>PCM202</b> Moments Sign M
9	<b>PCM701</b> Movable Hammocks	18	<b>PCM103931</b> Sandworks



# PHYSICAL CHALLENGE



## PLAY SOLUTION

Thrill is the key motivator for physical play and this playground is designed to let children enjoy the many modes of thrill. The play structures in this play area are immensely fun and thrilling.

The physical play challenges provide excitement in various ways, catering to different preferences and abilities. Children can go from one thrill to the next and be absorbed in play for hours.

**Let's play**





See more solutions  
on [kompan.com](https://www.kompan.com)

Minor regional deviations can occur due to differences in safety standards

## PRODUCT INFORMATION

Product number	Product name
1	GXY919 Flexus
2	GXY935 Starsurfer
3	ELE400063 Multispinner Carousel
4	PCE112531 Elements Cliff Rider
5	PCM804 Mini Hammock
6	GXY8016 Spica 3
7	KSW92008 Swing, 8 ft H, 1 Rope Seat
8	PAR4051 Agora Bench with Backrest
9	PCM202 Moments Sign M

# Let's play



# EARLY CLIMBING ROPE PLAY



## PLAY SOLUTION

When the little ones explore this vibrant, colorful jungle of rope play and “climb and crawl”, they slide, balance, and crawl through gently bouncing activities that create a response, wonder, and joyful laughter. Exploration is limitless as the standalone play elements seamlessly connect, offering simple yet fantastic ways to enhance playground activities. Rope play activities for younger children entice an “I can do this” attitude, improving self-confidence and self-esteem.

The transparency of these structures create a thrilling experience of height, but with parents or caregivers still in sight, it's a safe experience.

### Let's play





See more solutions  
on [kompan.com](http://kompan.com)

Minor regional deviations can occur due to differences in safety standards

## PRODUCT INFORMATION

Product number	Product name
1 CRP810201	Mini Dome with Slide
2 CRP200602	Meadow Trail
3 CRP201101	Play Shell Climber
4 M951	Sunflower
5 CRP201201	Wave Stepper
6 PAR4084	Agora Picnic Mini, Red
7 PCM155	Three-Seater Carousel

# Let's play



# SCHOOLYARD MAGNET



## PLAY SOLUTION

The bell rings and within minutes, the schoolyard is packed with children looking to expend their energies between lessons.

The large play structure invites children to come and slide, climb, and get a full view of the schoolyard. The dynamic play equipment gives children the exhilarating sensation as they rotate, spin, and swing.

**Let's play**





See more solutions  
on [kompan.com](http://kompan.com)

Minor regional deviations can occur due to differences in safety standards

## PRODUCT INFORMATION

Product number	Product name
1	PCM310631 Triple Tower Wackle
2	GXY960 Supernova
3	ELE500008 Spinner Plate
4	ELE400024 Spinner Bowl
5	COR20340 Rhombus Twister
6	PCM160 Scooter Carousel
7	KSW92009 Swing, 3 seat, 8 ft H, 1 Shell Seat
8	PCM201 Outdoor Play Timer
9	PAR4051 Agora Bench with Backrest

# Let's play



# PRE-SCHOOL FAVORITE



## PLAY SOLUTION

The Pre-School Favorite comes in vivid colors to attract children in the pre-school age. The happy colors also make the playground a joyful place to be for the kindergarten teachers.

A Pre-School Favorite fits any kindergarten or playground for the 2 to 6-year-olds.

**Let's play**





See more solutions  
on [kompan.com](https://www.kompan.com)

Minor regional deviations can occur due to differences in safety standards

## PRODUCT INFORMATION

Product number	Product name
1	PCM200431 Double Mega Deck with Tower
2	COR30281 Mini Spacenet
3	KSW92009 Swing, 3 seat, 8 ft H, 1 Shell Seat
4	ELE400158 Junior Spica
5	M101 Hen
6	PAR4051 Agora Bench with Backrest

# Let's play



# TODDLER'S PARADISE



## PLAY SOLUTION

The Toddler's Paradise is a safe world of play for toddlers. Shown here in a classic courtyard, it would also suit a kindergarten, a park, or a public square. The playful themes and colors invite children to play. The play equipment is placed on different sides of the "river", which adds extra play stories.

The variation of play equipment provides multiple ways of playing. The playground makes space for social play, role-play, and the opportunity to play alone.

**Let's Play**





See more solutions  
on [kompan.com](https://www.kompan.com)

Minor regional deviations can occur due to differences in safety standards

## PRODUCT INFORMATION

Product number	Product name
1	PCM505 Waterfall with Sand Table
2	PCM003121 Play Panel 2 - Music, Classic
3	M188 Little Duckling
4	MSC5424 Double Toddlers Castle
5	PCM804 Mini Hammock
6	M191 Toddler Spica
7	PCM104031 Sand Creator

# Let's play



# SEAFRONT



## PLAY SOLUTION

The Seafrost is a complete water theme designed to introduce water play elements into parks and urban settings, extending the aquatic ambiance from a nearby sea. The Seafrost theme lets children of all ages imagine the wonderful world of water without even getting wet.

Whatever activity, one thing is for sure – the variety in the play activities will keep the children absorbed in play for hours.

**Let's play**





See more solutions  
on [kompan.com](http://kompan.com)

Minor regional deviations can occur due to differences in safety standards

## PRODUCT INFORMATION

Product number	Product name
1	PCT111331 Ocean Giant XL
2	PCM102721 Frigate with Stairs
3	KSW92009 Swing, 3 seat, 8 ft H, 1 Shell Seat
4	M187 Ocean Seesaw
5	ELE400065 Tipi Carousel w/ Top Brace
6	PCM104 Dolphin, Double
7	KPL102 Sea Lion
8	ELE400024 Spinner Bowl
9	PAR4050 Agora Bench

Let's  
play



# AFRICAN SAFARI



## PLAY SOLUTION

The African Safari theme includes zoo animals to stimulate language development when children name animals and use them for dramatic play.

There is sensory play for the youngest and lots of rocking, balancing, spinning, sliding, and swinging opportunities. There are thrilling play activities that support body confidence for the soon-to-be teenagers.

The safari theme, with its different play activities, attracts children aged 1-12 years.

**Let's play**





Minor regional deviations can occur due to differences in safety standards

## PRODUCT INFORMATION

Product number	Product name	Product number	Product name
1	CRP812501 Explorer Dome	7	MSC5420 Elephant
2	GXY8016 Spica 3	8	MSC5416 Forest Giraffe
3	ELE400024 Spinner Bowl	9	M984 Cocowave Pendulum Swing
4	M165 Gorilla	10	M87202 Zipline, Flat Space
5	M243 Crocodile Bench	11	PCM114431 Cableway Start Platform
6	GXY8019 Argo	12	PAR1051 Anita Bench with Backrest



# SPACE TRAVEL



## PLAY SOLUTION

To be an astronaut, one has to be in excellent physical condition. The Space Travel theme calls upon children to be physically active, spin on the planets, climb structures, and jump from star to star. The Space Travel playground also inspires conversations about space, the physics, gravity, etc. As the majority of play takes place at ground level, or close to ground level, children with disabilities can be part of the play.

The many different activities in this design will make this playground an active place to play. Not only can it activate many children at the same time, but the many social and physical challenges will also keep them active for a long time.

**Let's play**





See more solutions  
on [kompan.com](https://www.kompan.com)

Minor regional deviations can occur due to differences in safety standards

## PRODUCT INFORMATION

Product number	Product name	Product number	Product name
1	ELE400024 Spinner Bowl	6	M87403 Stepping Pod, 2 ft
2	GXY8014 Spica 1	7	M87401 Stepping Pod, Ground Level
3	GXY902 Enif	8	BLX4103 BLOQX 3
4	PCM803 Triple Somersault Bars	9	PCM704 Meeting Point with Movable Hammocks
5	M87402 Stepping Pod, 1 ft	10	GXY958 Saturn 4 Carousel



# URBAN ARCHES



## PLAY SOLUTION

The Urban Arches playground attracts children and adults with its exciting shapes, colors, and play features. The fun arches and unique design are something you notice from a distance due to the playground's cool architectural expression.

The rope universe attracts and retains children of all ages and offers a wide variety of physical play to stimulate physical development by climbing the rope structures. The

different rope structures also provide many places for children to take a break, hang out, and socialize with their friends.

### Let's play





See more solutions  
on [kompan.com](http://kompan.com)

Minor regional deviations can occur due to differences in safety standards

## PRODUCT INFORMATION

Product number	Product name
1	COR17510 Butterfly, Physical
2	CRP812001 Sensory Dome
3	PCT802 FunPoint, Ultimate
4	PCM161 Turbo Carousel
5	M984 Cocowave Pendulum Swing
6	PCM157 Universal Carousel
7	PCM804 Mini Hammock
8	PAR3004 Sign Large

# Let's play



# URBAN JUNGLE



## PLAY SOLUTION

The Urban Jungle brings jungle fun into the city. This is where children can swing, climb, spin, and even rotate. The Urban Jungle fits well into any urban environment but can also fit into a school playground, a park, or a campground.

The area offers numerous physical activities that enable children to engage in various forms of active play, and the swings provide an enjoyable space for children to socialize while having fun.

The Urban Jungle is full of dynamic equipment that will develop children's cross-coordination skills and their sense of balance. Fundamental skills that support the ability to focus and navigate, including confidently managing street traffic.

### Let's play





See more solutions  
on [kompan.com](http://kompan.com)

Minor regional deviations can occur due to differences in safety standards

**PRODUCT INFORMATION**

Product number	Product name	Product number	Product name
1	CRP812501 Explorer Dome	6	SW990011 Swing Seat, Stainless, 8 ft
2	COR20301 Net Twister	7	SW990081 Shell Nest, 39in wide, 8 ft
3	GXY960 Supernova	8	GXY8014 Spica 1
4	KSW924 Swing Frame, 4 Seat, 8 ft H	9	ELE400024 Spinner Bowl
5	SW990205 Inclusive Seat, 8 ft H, 2-Chain	10	PAR4054 Agora Steel Bench with Backrest



# PIRATE BAY



## PLAY SOLUTION

The pirate ship has been followed by cyclones and dolphins. Now it is entering the harbor of the bay. The sailors have put the boat in the water and set sail towards the small village. On the beach, the inhabitants are ready to meet the sailors. Children's fantasies can take many forms. The robinia play structure matches many environments. It complements the natural surroundings of a park and mends the hard feel of urban environments.

The many different themed play activities will retain children for hours as they create their own play stories. Pirates, shipwrecks, inhabitants of a secluded village in the jungle...only the imagination sets the boundaries.

### Let's Play





See more solutions  
on [kompan.com](http://kompan.com)

Minor regional deviations can occur due to differences in safety standards

## PRODUCT INFORMATION

Product number	Product name
1 NRO547	Explorer ship, Large
2 ELE400024	Spinner Bowl
3 NRO120	Carousel with Seats
4 NRO529	Oasis Sand Boat with Sail
5 NRO111	Dolphin Springer
6 NRO212	Kids Table with 4 Sitting Poles
7 NRO912	Double Swing Combination
8 NRO3003	Robina Cliff Rider, H:238cm

# Let's play



# ROBINIA FANTASY



## PLAY SOLUTION

Deep in the Forest of Fantasy is a magical play space with charmed play structures. Packed with play activities, children of all ages and abilities are in for an exhilarating play experience as they explore fantasy-themed play activities. In the universe of Robinia Fantasy, children must slide, climb, hide, balance, and jump to avoid an eternal no-play spell. Unbeknownst to the Warlock, children strengthen their coordination and agility while venturing

through the obstacles of the play structures, enabling them to resist the spell. This solution is packed with numerous play activities, challenging children on their way through the realm of fantasy, where imaginations run free.

**Let's play**





See more solutions  
on [kompan.com](http://kompan.com)

Minor regional deviations can occur due to differences in safety standards

## PRODUCT INFORMATION

Product number	Product name	Product number	Product name
1	NRC200201 Spellbound Shack	5	NRO120 Carousel with Seats
2	NRC400101 Warlock's Escape	6	NRO915 Cocowave Rope Pendulum Swing
3	NRO118 Bee Springer	7	NRC60101 Stack & Turn Play Panel
4	NRO115 Snail Springer	8	NRC60201 Triple Wonder Play Panel



# WILD JUNGLE



## PLAY SOLUTION

The Wild Jungle is designed for a natural atmosphere. The gentle, wooden look allows this play design to fit into and enhance any natural setting or even help bring a natural feel into an urban environment. The jungle theme inspires children's natural instinct to play.

The versatile play options keep children occupied for hours on end. While the children play and have fun, their skill sets develop from

the many different types of play – physical, social, and cognitive. The children train their sense of balance, cross-coordination, and social-emotional skills while having fun. Many of the activities and the playground layout include children from 2 to 12 years and of all abilities.

### Let's play





See more solutions on [kompan.com](http://kompan.com)

Minor regional deviations can occur due to differences in safety standards

**PRODUCT INFORMATION**

Product number	Product name	Product number	Product name
1	NRO209 Sitting Pole, Natural	7	NRO875 Zipline, Sloped Space
2	NRO832 Balance posts with rope	8	NRO836 Jungle Dome
3	NRO806 Stilts	9	NRO518 Lizard Sculpture, Oak
4	NRO409 The Wizard's Hideaway	10	NRO515 Ara Parrot Sculpture
5	NRO916 Robinia Flower Swing	11	NRO564 Propeller Plane
6	NRO417 Little Hen's House	12	PAR1050 Anita Bench



# GOLD RUSH



## PLAY SOLUTION

The old gold mine from the past is still standing. The natural wood material makes for a nice contrast in an urban environment. This theme fits into all kinds of different contexts.

The varied areas, play equipment, and surfaces invite different activity levels and play scenarios. This makes the playground appealing to children of varying age groups. Dig in the sand and rinse the sand away in the water to find small gold pieces. Edges and sitting areas provide parents and grandparents the opportunity to be part of the activity.

The Gold Rush theme will inspire children for dramatic play, which stimulates language development and social interaction. The playground is inclusive for children of all abilities.

### Let's play





See more solutions  
on [kompan.com](https://www.kompan.com)

Minor regional deviations can occur due to differences in safety standards

## PRODUCT INFORMATION

Product number	Product name	Product number	Product name
1	NRO524 Excavator	6	NRO112 Forest Bug Springer
2	NRO534 Oasis Creator	7	NRO217 Robinia Sign Medium
3	NRO910 Two Seat Swing	8	PAR4070 Agora Picnic Table
4	NRO212 Kids Table with 4 Sitting Poles	9	PAR4050 Agora Bench
5	NRO508 Water Channel with Splash Table		







# THEMED PLAY SYSTEMS





# GIANTS

## Taking the Element of WOW to New Heights!

The towering Giants come at a staggering height of 22 to 30 feet. A small footprint does not mean fewer play activities – quite the opposite. Filled with physical and cognitive play activities from top to bottom, inside and out, they are designed to WOW and challenge school-aged children.

The thrilling slide and themed exterior add to the excitement as Giants entice children to challenge and explore heights that wow!

See options on the FLEXIBILITY page.



Giant L Base  
PCT110931



### For a greener future

#### Post-consumer recycled materials:

EcoCore™ Panels	>95%
Hollow Plastic Parts	33%
Hercules Rope Yarn	>95%
Molded Decks	75%

Extruded aluminium made with low-carbon aluminium  
Steel parts adhere to industrial standards



Ocean Giant L  
PCT111031



Palace Giant L  
PCT111131

## PRODUCT INFORMATION

Product number	Product name	Age (years)	Capacity (users)	Fall height (ft & in)	Total height (ft & in)	Use zone dimensions (ft <sup>2</sup> )	Use zone dimensions (ft & in x ft & in)	Installation (hours)	Total CO <sub>2</sub> e (kg CO <sub>2</sub> e)
PCT110931	Giant L Base	5 - 12	36	9'4"	21'4"	1192	43'3" x 50'10"	153	5,307
PCT111031	Ocean Giant L	5 - 12	36	9'4"	21'4"	1171	40'9" x 52'9"	140	6,266
PCT111131	Palace Giant L	5 - 12	36	9'4"	21'4"	1171	40'9" x 52'9"	140	6,266





Palace Giant L & Side Tower  
PCT210831



Giant L & Side Tower  
PCT210631



Ocean Giant L & Side Tower  
PCT210731

## PRODUCT INFORMATION

Product number	Product name	Age (years)	Capacity (users)	Fall height (ft & in)	Total height (ft & in)	Use zone dimensions (ft <sup>2</sup> )	Use zone dimensions (ft & in x ft & in)	Installation (hours)	Total CO <sub>2</sub> e (kg CO <sub>2</sub> e)
PCT210831	Palace Giant L & Side Tower	5 - 12	50	9'4"	21'4"	1413	48'7" x 53'5"	165	7,464
PCT210631	Giant L & Side Tower	5 - 12	50	9'4"	21'4"	1414	49'6" x 54'3"	177	6,505
PCT210731	Ocean Giant L & Side Tower	5 - 12	50	9'4"	21'4"	1413	48'7" x 53'5"	165	7,464



# GIANTS



Ocean Giant XL  
PCT111331



Giant XL  
PCT111231



Palace Giant XL  
PCT111431

## PRODUCT INFORMATION

Product number	Product name	Age (years)	Capacity (users)	Fall height (ft & in)	Total height (ft & in)	Use zone dimensions (ft <sup>2</sup> )	Use zone dimensions (ft & in x ft & in)	Installation (hours)	Total CO <sub>2</sub> e (kg CO <sub>2</sub> e)
PCT111331	Ocean Giant XL	5 - 12	60	9'2"	29'3"	1385	42'6" x 52'8"	202	10,230
PCT111231	Giant XL	5 - 12	60	9'2"	29'3"	1406	45'1" x 52'7"	230	8,874
PCT111431	Palace Giant XL	5 - 12	60	9'2"	29'3"	1385	42'6" x 52'8"	202	10,230





## Equity in play and ramped solutions

For some play solutions, ramps are the best way to provide usability and accessibility for children or caregivers with different abilities. KOMPAN GIANTS ramp solutions are modular and can be accessed from ground level and up, or from an elevated level, utilizing the other landscape features to ease access.

Contact us for more information and let us help you create an exciting ramp solution and inclusive play environment.





# GIANTS



Giant M, Sensory  
PCT111731



Giant L, Sensory  
PCT111831

## PRODUCT INFORMATION

Product number	Product name	Age (years)	Capacity (users)	Fall height (ft & in)	Total height (ft & in)	Use zone dimensions (ft <sup>2</sup> )	Use zone dimensions (ft & in x ft & in)	Installation (hours)	Total CO <sub>2</sub> e (kg CO <sub>2</sub> e)
PCT111731	Giant M, Sensory	5 - 12	32	9'9"	18'5"	803	32'3" x 36'4"	51	4,161
PCT111831	Giant L, Sensory	5 - 12	36	9'9"	21'4"	1389	43'3" x 54'11"	87	6,267



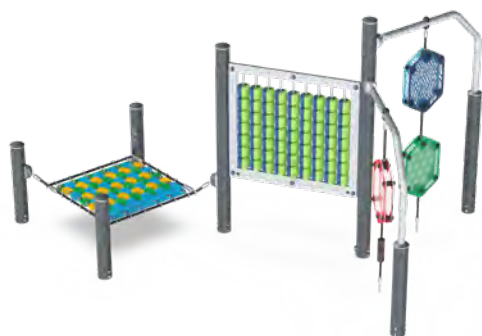

FunPoint, Creator  
PCT801



FunPoint, Hangout  
PCT804



FunPoint, Climber  
PCT803



FunPoint, Ultimate  
PCT802

## PRODUCT INFORMATION

Product number	Product name	Age (years)	Capacity (users)	Fall height (ft & in)	Total height (ft & in)	Use zone dimensions (ft <sup>2</sup> )	Use zone dimensions (ft & in x ft & in)	Installation (hours)	Total CO <sub>2</sub> e (kg CO <sub>2</sub> e)
PCT801	FunPoint, Creator	2 - 12	8	1'1"	6'1"	339	18'6" x 22'6"	7.9	729
PCT804	FunPoint, Hangout	2 - 12	6	1'1"	10'6"	548	28'5" x 26'5"	10	1,010
PCT803	FunPoint, Climber	5 - 12	12	6'9"	10'2"	446	27'4" x 23'9"	16	1,106
PCT802	FunPoint, Ultimate	5 - 12	16	4'12"	10'2"	644	31'6" x 27'9"	20	1,623



# FLEXIBILITY

With a variety of colors and part options, we offer lots of flexibility and customization with our standard products.



Ocean Giant



Giant M, Sensory



Giant Nature



Palace Giant



Giant Modern





Play panels

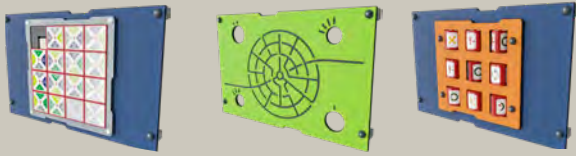

Graphic panels



Sensory & hang-out activities

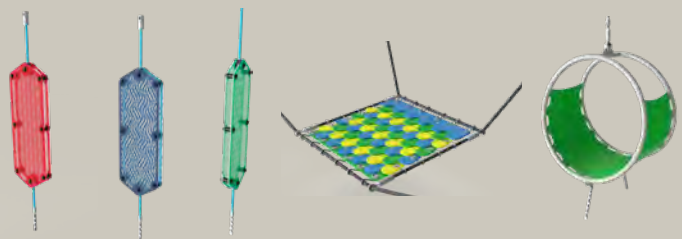

Slides in PE or stainless steel

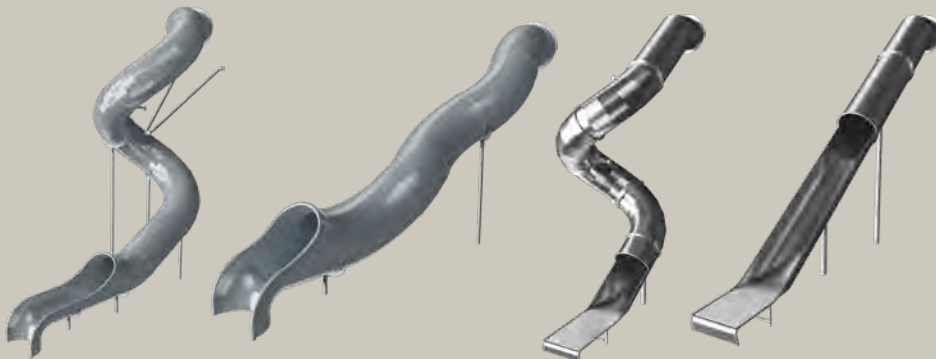

Anti-climb panels



NOTE:  
Steel slides heated by the midday sun can cause severe skin burns. We recommend pointing steel slides away from the midday sun or using PE slides or shading.

Giants linked together



## More flexibility

Contact us for more information on the wide range of options for configurable playground equipment. Please note that prices and delivery terms depend on specified configurations.



# TODDLER MULTIPLAY

## Colorful Play for Toddlers

Playing is how toddlers learn about the world around them. They practice new skills, explore their imagination, and make new friends. Familiar themes create playful conversations and the elevated playhouses provide a physical climbing challenge with an area underneath for a play break.

Toddlers can safely explore and find their place in the world playing on a Multiplay structure.



Double Toddlers Castle  
MSC5424



### For a greener future

Post-consumer recycled materials:

EcoCore™ Panels  
TexMade™ Posts

>95%  
>95%

Steel parts adhere to industrial standards



Treehouse Slide  
MSC5402

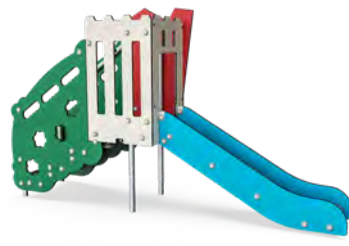

Little Treehouse Slide  
MSC540202



Toddlers Town  
MSC5427



Playhouse Slide  
MSC5417



Toddlers Castle with Rock Climber  
MSC5422



Home & Garden, 2 Rooms  
MSC542102

## PRODUCT INFORMATION

Product number	Product name	Age (years)	Capacity (users)	Fall height (ft & in)	Total height (ft & in)	Use zone dimensions (ft <sup>2</sup> )	Use zone dimensions (ft & in x ft & in)	Installation (hours)	Total CO <sub>2</sub> e (kg CO <sub>2</sub> e)
MSC5424	Double Toddlers Castle	2 - 5	15	1'12"	4'11"	365	22'7" x 21'1"	14	459
MSC5402	Treehouse Slide	2 - 5	2	1'12"	4'8"	241	19'11" x 13'10"	6.6	163
MSC540202	Little Treehouse Slide	6m - 2	3	1'12"	4'8"	238	19'11" x 13'9"	7.5	196
MSC5427	Toddlers Town	2 - 5	2	1'12"	4'7"	241	19'11" x 13'9"	7.3	175
MSC5417	Playhouse Slide	2 - 5	8	1'12"	4'11"	301	21'1" x 18'9"	8.9	279
MSC5422	Toddlers Castle with Rock Climber	2 - 5	12	1'12"	4'11"	309	21'1" x 19'7"	9.8	311
MSC542102	Home & Garden, 2 Rooms	6m - 4	16	1'6"	5'7"	300	18'4" x 19'2"	12	224



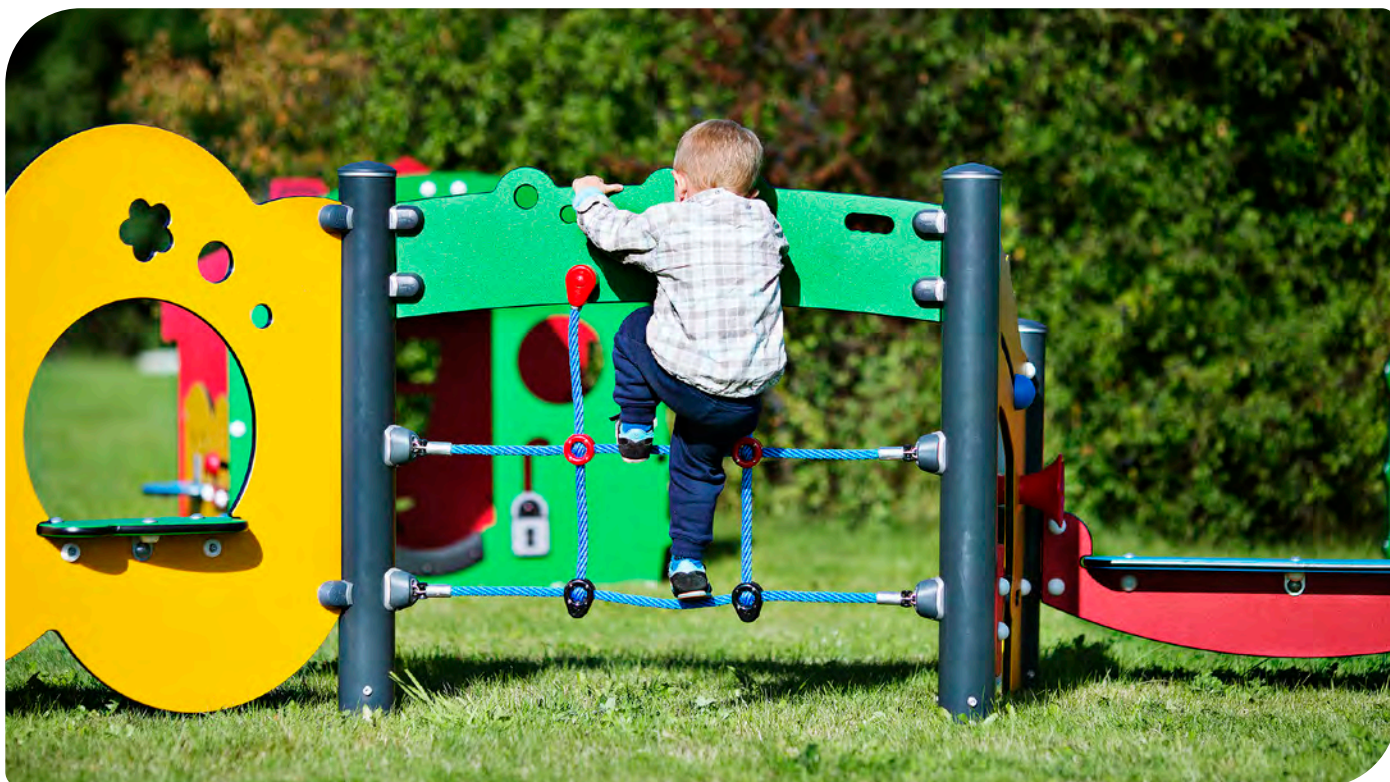

Home & Garden, 3 Rooms  
MSC542103



Talk & Tumble  
PCM000321



Talk & Tumble with Net  
PCM000421



Talk & Tumble with Tunnel  
PCM000521



## PRODUCT INFORMATION

Emission: Standard version / Greenest version

Product number	Product name	Age (years)	Capacity (users)	Fall height (ft & in)	Total height (ft & in)	Use zone dimensions (ft <sup>2</sup> )	Use zone dimensions (ft & in x ft & in)	Installation (hours)	Total CO <sub>2</sub> e (kg CO <sub>2</sub> e)
MSC542103	Home & Garden, 3 Rooms	6m - 4	20	1'6"	5'7"	374	20'5" x 19'3"	15	312 / -
PCM000321	Talk & Tumble	6m - 4	8	0'0"	3'3"	-	0'0" x 0'0"	5.1	143 / 109
PCM000421	Talk & Tumble with Net	6m - 4	14	3'3"	3'6"	362	25'6" x 22'1"	8	294 / 238
PCM000521	Talk & Tumble with Tunnel	6m - 4	13	0'4"	3'6"	353	23'2" x 19'7"	8.5	365 / 287



# STORY MAKERS™

## Storytelling and Play

Story Makers™ is one big invitation to play. This range offers a two-level play space with bright colors, friendly shapes, and rounded edges. With multiple design options, panels can change according to your plan, making Story Makers™ as flexible as possible.

When playing on the structures from Story Makers™, they can create and act out their own play story. Little explorers love a good story.



### For a greener future

#### Post-consumer recycled materials:

EcoCore™ Panels  
Hollow Plastic Parts

>95%  
33%

Steel parts adhere to industrial standards



Home & Rescue  
MSC6407



Ocean & Jungle with Net Tower  
MSC6410



Home & Rescue with Net Tower  
MSC6411



Ocean & Jungle  
MSC6408



## PRODUCT INFORMATION

Product number	Product name	Age (years)	Capacity (users)	Fall height (ft & in)	Total height (ft & in)	Use zone dimensions (ft²)	Use zone dimensions (ft & in x ft & in)	Installation (hours)	Total CO <sub>2</sub> e (kg CO <sub>2</sub> e)
MSC6407	Home & Rescue	2 - 5	20	7'5"	9'4"	516	28'7" x 26'2"	26	1,407
MSC6410	Ocean & Jungle with Net Tower	2 - 5	32	7'5"	9'5"	728	39'3" x 27'9"	32	1,872
MSC6411	Home & Rescue with Net Tower	2 - 5	30	7'5"	9'4"	725	39'1" x 27'9"	33	1,901
MSC6408	Ocean & Jungle	2 - 5	22	7'5"	9'5"	517	28'5" x 26'2"	25	1,377





Palace & Fortress with Bridge & Tower  
**MSC6418**

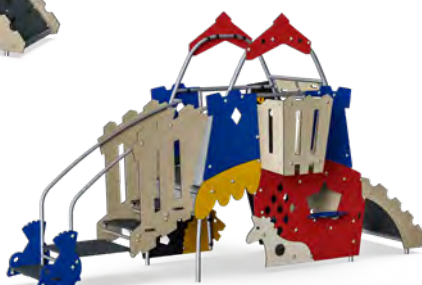

Palace & Fortress  
**MSC6416**



Adventure Tower  
**MSC6419**



Home & Rescue with Bridge & Tower  
**MSC6421**



Story Makers Castle  
**MSC6422**



Shop & Construction  
**MSC6424**

**PRODUCT INFORMATION**

Product number	Product name	Age (years)	Capacity (users)	Fall height (ft & in)	Total height (ft & in)	Use zone dimensions (ft <sup>2</sup> )	Use zone dimensions (ft & in x ft & in)	Installation (hours)	Total CO <sub>2</sub> e (kg CO <sub>2</sub> e)
<b>MSC6418</b>	Palace & Fortress with Bridge & Tower	2 - 5	32	6'4"	9'5"	903	37'7" x 36'2"	36	2,241
<b>MSC6416</b>	Palace & Fortress	2 - 5	19	3'11"	9'5"	502	28'8" x 24'4"	22	1,280
<b>MSC6419</b>	Adventure Tower	2 - 5	12	6'4"	7'8"	488	32'1" x 20'12"	14	786
<b>MSC6421</b>	Home & Rescue with Bridge & Tower	2 - 5	35	6'4"	9'4"	901	37'7" x 35'12"	40	2,339
<b>MSC6422</b>	Story Makers Castle	2 - 5	34	7'5"	13'3"	961	32'5" x 41'7"	48	2,766
<b>MSC6424</b>	Shop & Construction	2 - 5	22	3'11"	9'6"	494	29'2" x 23'2"	25	1,296



# FAIRY TALES BY H.C. ANDERSEN™

## Once Upon a Time...

The Hans Christian Andersen-themed playground equipment comprises enticing and standalone play structures. Children learn about good social conduct through fairy tales' moral insights and universal truths.

Whether it's digital or physical play, these fairy-tale structures provide hours of play activities for one-to-eight-year-olds.



### For a greener future

#### Post-consumer recycled materials:

EcoCore™ Panels  
Hollow Plastic Parts

>95%  
33%

Steel parts adhere to industrial standards



Chicken Farm & Horse Carriage  
MSC5426



Little Mermaid & Ugly Duckling  
MSC6430



Little Mermaid & Tinderbox  
MSC6431

## PRODUCT INFORMATION

Product number	Product name	Age (years)	Capacity (users)	Fall height (ft & in)	Total height (ft & in)	Use zone dimensions (ft²)	Use zone dimensions (ft & in x ft & in)	Installation (hours)	Total CO <sub>2</sub> e (kg CO <sub>2</sub> e)
MSC5426	Chicken Farm & Horse Carriage	2 - 5	8	1'12"	5'5"	282	18'10" x 18'9"	11	273
MSC6430	Little Mermaid & Ugly Duckling	2 - 5	24	7'5"	12'1"	515	28'10" x 25'9"	34	1,525
MSC6431	Little Mermaid & Tinderbox	2 - 5	22	7'5"	12'1"	513	28'10" x 25'9"	32	1,475





Little Mermaid & Ugly Duckling Castle  
MSC6434



Little Mermaid & Tinderbox Castle  
MSC6435

## PRODUCT INFORMATION

Product number	Product name	Age (years)	Capacity (users)	Fall height (ft & in)	Total height (ft & in)	Use zone dimensions (ft²)	Use zone dimensions (ft & in x ft & in)	Installation (hours)	Total CO <sub>2</sub> e (kg CO <sub>2</sub> e)
MSC6434	Little Mermaid & Ugly Duckling Castle	2 - 5	32	7'5"	12'1"	732	39'5" x 27'9"	44	2,063
MSC6435	Little Mermaid & Tinderbox Castle	2 - 5	30	7'5"	12'1"	731	39'5" x 27'9"	42	2,039



# MOMENTS™ CASTLES

## Defend the Castle!

A playground castle is no cause for distress – whether you're a damsel in distress or not! Get ready for action and adventures fit for kings and queens! Castle-themed play structures are packed with fun and hours of role-play. Thrill kids on all levels!

Explore the dungeons, prison cells, and caves below – or swing from the ramparts to defend your castle from the dragon.



### For a greener future

#### Post-consumer recycled materials:

EcoCore™ Panels	>95%
Hollow Plastic Parts	33%
Hercules Rope Yarn	>95%
Molded Decks	75%

Extruded aluminium made with low-carbon aluminium  
Steel parts adhere to industrial standards



Four Tower Castle  
PCM410731



Castle Spire Tower  
PCM102931



Castle Gatehouse  
PCM201831



Castle Castello  
PCM400831



Castle Watch Tower  
PCM112731



Castle Outpost Tower  
PCM112931



Castle Fortress  
PCM113131

## PRODUCT INFORMATION

Product number	Product name	Age (years)	Capacity (users)	Fall height (ft & in)	Total height (ft & in)	Use zone dimensions (ft²)	Use zone dimensions (ft & in x ft & in)	Installation (hours)	Total CO <sub>2</sub> e (kg CO <sub>2</sub> e)
PCM410731	Four Tower Castle	5 - 12	42	9'4"	15'5"	1012	35'6" x 37'2"	56	3,763
PCM102931	Castle Spire Tower	2 - 5	12	3'10"	13'5"	379	22'11" x 21'7"	17	895
PCM201831	Castle Gatehouse	2 - 5	18	6'8"	13'5"	501	29'0" x 22'7"	23	1,422
PCM400831	Castle Castello	2 - 5	31	6'8"	13'5"	675	35'8" x 26'4"	39	2,381
PCM112731	Castle Watch Tower	5 - 12	17	7'9"	16'5"	491	20'11" x 32'6"	23	1,313
PCM112931	Castle Outpost Tower	5 - 12	26	8'1"	15'5"	851	33'1" x 44'3"	31	2,000
PCM113131	Castle Fortress	5 - 12	31	9'10"	19'9"	949	40'9" x 37'10"	48	4,308





Castle's Outer Gate  
PCM212531

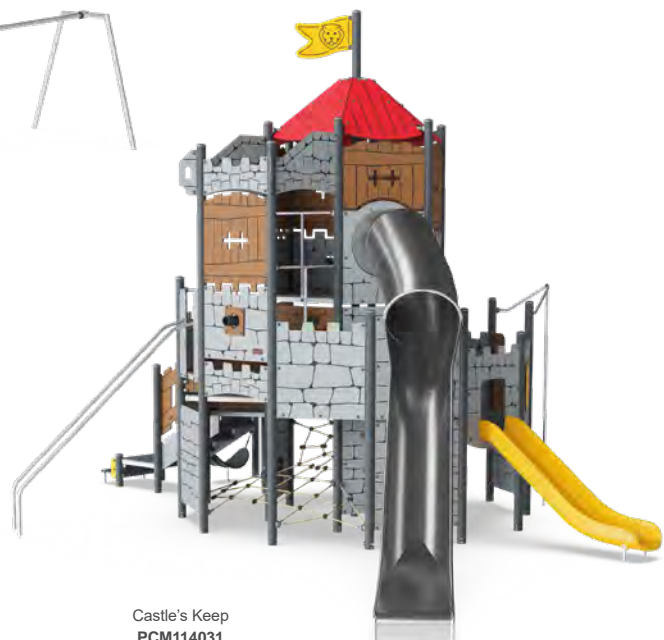

Castle's Keep  
PCM114031

## PRODUCT INFORMATION

Product number	Product name	Age (years)	Capacity (users)	Fall height (ft & in)	Total height (ft & in)	Use zone dimensions (ft <sup>2</sup> )	Use zone dimensions (ft & in x ft & in)	Installation (hours)	Total CO <sub>2</sub> e (kg CO <sub>2</sub> e)
PCM212531	Castle's Outer Gate	5 - 12	35	6'6"	15'5"	1001	48'0" x 49'9"	48	2,821
PCM114031	Castle's Keep	5 - 12	58	8'10"	19'9"	1004	42'5" x 35'4"	59	5,161



# MOMENTS™ PIRATE SHIPS

## Pirates, Take Notice!

If your playground needs an overhaul and barnacles have settled on your springers, look no further than these amazing pirate ship-themed structures equipped with various adventurous play activities.

You'll find all you need for children to create high-seas adventures both topside and below deck. All aboard!



### For a greener future

#### Post-consumer recycled materials:

EcoCore™ Panels	>95%
Hollow Plastic Parts	33%
Hercules Rope Yarn	>95%
Molded Decks	75%

Extruded aluminium made with low-carbon aluminium  
Steel parts adhere to industrial standards



Frigate with Stairs  
PCM102721



Man-O-War with Stairs  
PCM113331



Pirate Ship  
PCM103231



Caravelle with Stairs  
PCM102631

## PRODUCT INFORMATION

Product number	Product name	Age (years)	Capacity (users)	Fall height (ft & in)	Total height (ft & in)	Use zone dimensions (ft²)	Use zone dimensions (ft & in x ft & in)	Installation (hours)	Total CO <sub>2</sub> e (kg CO <sub>2</sub> e)
PCM102721	Frigate with Stairs	2 - 5	35	4'10"	18'5"	786	38'1" x 32'6"	42	2,381
PCM113331	Man-O-War with Stairs	5 - 12	54	6'10"	18'5"	1273	43'7" x 44'7"	100	3,987
PCM103231	Pirate Ship	2 - 5	24	4'10"	12'6"	711	33'2" x 34'3"	36	1,793
PCM102631	Caravelle with Stairs	2 - 5	15	3'10"	14'6"	484	29'3" x 23'6"	20	1,060





The Intrepid with Stairs  
PCM113531

## PRODUCT INFORMATION

Product number	Product name	Age (years)	Capacity (users)	Fall height (ft & in)	Total height (ft & in)	Use zone dimensions (ft <sup>2</sup> )	Use zone dimensions (ft & in x ft & in)	Installation (hours)	Total CO <sub>2</sub> e (kg CO <sub>2</sub> e)
PCM113531	The Intrepid with Stairs	5 - 12	72	8'10"	21'8"	1460	60'7" x 41'8"	100	7,695



# MOMENTS™ THEMED PLAY

## Harvesting Fun

Play is about preparing for life and reaches its strongest potential in inspiring young imaginations through the imitation of reality. Farm-themed playground equipment opens the door to adventures that would otherwise be “off limits”.

The thrill of climbing on a giant tractor triggers real-life scenarios on the farm, where the barn is stocked, not with hay, but with stacks of endless fun.



### For a greener future

#### Post-consumer recycled materials:

EcoCore™ Panels	>95%
Hollow Plastic Parts	33%
Hercules Rope Yarn	>95%
Molded Decks	75%

Extruded aluminium made with low-carbon aluminium  
Steel parts adhere to industrial standards



Tractor with Slide & Stairs  
PCM51131



Digger with Slide  
PCM51331



Barn  
PCM51531

## PRODUCT INFORMATION

Product number	Product name	Age (years)	Capacity (users)	Fall height (ft & in)	Total height (ft & in)	Use zone dimensions (ft²)	Use zone dimensions (ft & in x ft & in)	Installation (hours)	Total CO <sub>2</sub> e (kg CO <sub>2</sub> e)
PCM51131	Tractor with Slide & Stairs	2 - 5	19	3'10"	9'7"	540	30'8" x 21'9"	35	1,742
PCM51331	Digger with Slide	2 - 5	18	3'10"	9'1"	424	28'10" x 17'9"	27	1,186
PCM51531	Barn	2 - 5	18	6'8"	11'1"	532	27'0" x 25'8"	22	1,885



# FLEXIBILITY

With a variety of colors and part options, we offer lots of flexibility and customization with our standard products.



Red



Green



Blue



Red



Green

# OPTIONS



PRODUCT CONFIGURATOR  
www.kompan.com

Slides in PE or stainless steel

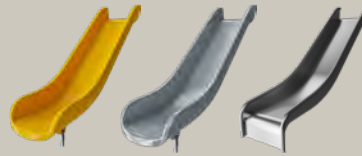

NOTE:  
Steel slides heated by the midday sun can cause severe skin burns. We recommend pointing steel slides away from the midday sun or using PE slides or shading.

Play activities



Climbing and staircase access points

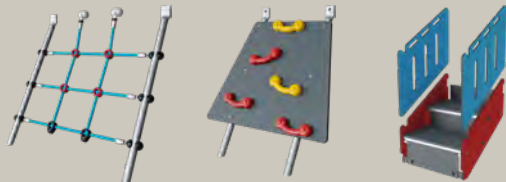

Graphic panels



Posts



Anthracite  
grey steel

Nut brown  
steel

Black  
aluminium

## More flexibility

Contact us for more information on the wide range of options for configurable playground equipment. Please note that prices and delivery terms depend on specified configurations.



# MOMENTS™ MINI

## A Play Space Designed by You

Moments™ Mini is a holistic, flexible, classic-looking play concept that embraces all stages of a child's learning and development. Choose from several color options and materials to create imaginative play scenarios for the little ones.

Incorporate play panels with themed play elements without boundaries to where the play stories go. You are the designer.

See options on the FLEXIBILITY page.



Four Towers with Net & Bridges  
PCM400531



### For a greener future

#### Post-consumer recycled materials:

EcoCore™ Panels	>95%
Hollow Plastic Parts	33%
Hercules Rope Yarn	>95%
Molded Decks	75%
TexMade™ Posts	>95%

Extruded aluminium made with low-carbon aluminium  
Steel parts adhere to industrial standards



Play Tower  
PCM101031



Play Tower, U2 Slide  
PCM104231



Play Tower with Double Floor  
PCM101231



Two Towers with Bridge  
PCM200531



Play Tower & House with Balcony  
PCM200631



Triple Play Tower with Bridge  
PCM300531

## PRODUCT INFORMATION

Emission: Standard version / TexMade™ version

Product number	Product name	Age (years)	Capacity (users)	Fall height (ft & in)	Total height (ft & in)	Use zone dimensions (ft²)	Use zone dimensions (ft & in x ft & in)	Installation (hours)	Total CO <sub>2</sub> e (kg CO <sub>2</sub> e)
PCM400531	Four Towers with Net & Bridges	2 - 5	36	6'8"	10'0"	657	32'10" x 25'5"	34	1,504 / 1,615
PCM101031	Play Tower	2 - 5	12	1'11"	6'11"	311	20'3" x 20'6"	12	378 / 399
PCM104231	Play Tower, U2 Slide	6m - 2	11	1'11"	6'11"	286	18'8" x 19'6"	12	379 / 421
PCM101231	Play Tower with Double Floor	2 - 5	13	1'11"	6'11"	333	20'3" x 21'7"	14	467 / 508
PCM200531	Two Towers with Bridge	2 - 5	16	1'11"	6'11"	432	25'3" x 23'1"	16	659 / 670
PCM200631	Play Tower & House with Balcony	2 - 5	24	1'11"	7'1"	428	24'8" x 21'8"	21	734 / 787
PCM300531	Triple Play Tower with Bridge	2 - 5	29	1'11"	6'11"	540	25'3" x 29'5"	25	1,001 / 1,039





Playhouse with Desk  
PCM001621



Playhouse with Outside Desk  
PCM001821



Playhouse with Bench  
PCM002331



Playhouse with Balcony  
PCM003531



Multi Deck Playhouse with Roof  
PCM002431



Multi Deck Playhouse  
PCM002531

## PRODUCT INFORMATION

Emission: Standard version / Greenest version

Product number	Product name	Age (years)	Capacity (users)	Fall height (ft & in)	Total height (ft & in)	Use zone dimensions (ft <sup>2</sup> )	Use zone dimensions (ft & in x ft & in)	Installation (hours)	Total CO <sub>2</sub> e (kg CO <sub>2</sub> e)
PCM001621	Playhouse with Desk	6m - 5	4	0'0"	6'1"	-	0'0" x 0'0"	5.5	208 / 149
PCM001821	Playhouse with Outside Desk	6m - 5	6	0'0"	6'1"	-	0'0" x 0'0"	6.7	241 / 174
PCM002331	Playhouse with Bench	2 - 5	17	0'11"	6'1"	306	20'10" x 20'9"	13	511 / 409
PCM003531	Playhouse with Balcony	6m - 5	15	0'11"	6'1"	257	19'3" x 17'2"	12	466 / 376
PCM002431	Multi Deck Playhouse with Roof	2 - 5	17	1'11"	7'0"	364	20'4" x 23'1"	19	835 / 644
PCM002531	Multi Deck Playhouse	2 - 5	18	2'11"	8'12"	423	22'7" x 24'9"	21	1,117 / 868



# MOMENTS™ MINI



Multi Play Tower & Playhouses  
PCM900131



Play Tower with Slide  
PCM101431



Play Tower with Balcony  
PCM101631



Multi Deck Play Tower  
PCM101731



Play Tower with Climbing Net  
PCM101531



Multi Deck Play Tower  
PCM200831



Two Towers with Curved Bridge  
PCM201031

## PRODUCT INFORMATION

Emission: Standard version / Greenest version

Product number	Product name	Age (years)	Capacity (users)	Fall height (ft & in)	Total height (ft & in)	Use zone dimensions (ft <sup>2</sup> )	Use zone dimensions (ft & in x ft & in)	Installation (hours)	Total CO <sub>2</sub> e (kg CO <sub>2</sub> e)
PCM900131	Multi Play Tower & Playhouses	2 - 5	73	6'8"	10'0"	1294	46'2" x 39'2"	68	4,484 / 3,504
PCM101431	Play Tower with Slide	2 - 5	12	2'11"	5'7"	338	20'1" x 22'4"	12	552 / 434
PCM101631	Play Tower with Balcony	2 - 5	16	3'10"	6'7"	408	23'11" x 21'10"	17	854 / 689
PCM101731	Multi Deck Play Tower	2 - 5	17	3'10"	10'0"	436	25'1" x 23'5"	20	1,036 / 819
PCM101531	Play Tower with Climbing Net	2 - 5	13	3'10"	10'0"	434	25'11" x 21'7"	15	884 / 724
PCM200831	Multi Deck Play Tower	2 - 5	19	2'11"	9'1"	517	29'8" x 24'6"	19	1,027 / 794
PCM201031	Two Towers with Curved Bridge	2 - 5	21	3'10"	10'0"	548	32'8" x 23'6"	21	1,252 / 970





Two Towers with Climbing Net  
PCM201231

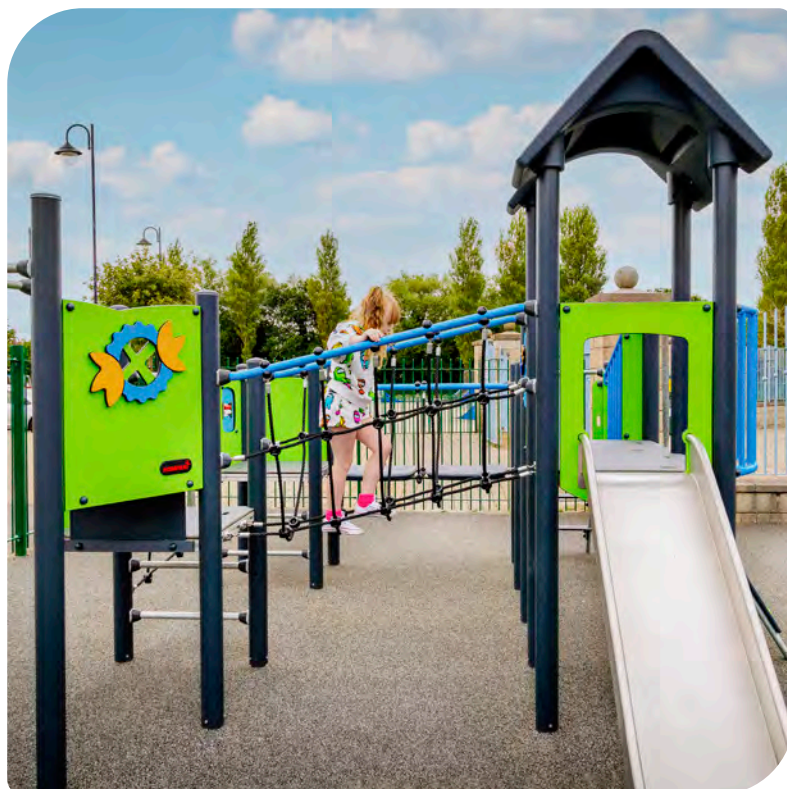

Two Towers with Tunnel Bridge  
PCM201331



Three Towers with Net & Bridge  
PCM300831



Four Towers with Tunnel  
PCM400231

## PRODUCT INFORMATION

Emission: Standard version / Greenest version

Product number	Product name	Age (years)	Capacity (users)	Fall height (ft & in)	Total height (ft & in)	Use zone dimensions (ft <sup>2</sup> )	Use zone dimensions (ft & in x ft & in)	Installation (hours)	Total CO <sub>2</sub> e (kg CO <sub>2</sub> e)
PCM201231	Two Towers with Climbing Net	2 - 5	23	6'8"	10'0"	547	24'9" x 27'8"	23	1,430 / 1,147
PCM201331	Two Towers with Tunnel Bridge	2 - 5	25	3'10"	10'0"	660	33'9" x 26'10"	32	1,655 / 1,301
PCM300831	Three Towers with Net & Bridge	2 - 5	28	3'10"	10'0"	707	34'8" x 30'7"	33	1,843 / 1,463
PCM400231	Four Towers with Tunnel	2 - 5	29	2'2"	6'11"	536	28'1" x 24'1"	26	1,414 / 1,134



# FLEXIBILITY

MOMENTS™ Play System



With a variety of colors and part options, we offer lots of flexibility and customization with our standard products.



Beige



Orange



Blue



Green



Red



Lime



Teal



Pine Wood

## Greenest version

Is fitted with TexMade™ posts as the standard option, making it the version with the lowest possible carbon emissions factor. TexMade™ posts can also be selected for the other color versions.





### PE slides



#### PE slide colors



### Stainless steel slides and activities

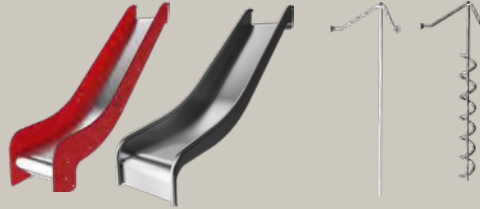

#### NOTE:

Steel slides heated by the midday sun can cause severe skin burns. We recommend pointing steel slides away from the midday sun or using PE slides or shading.

### Climbing activities

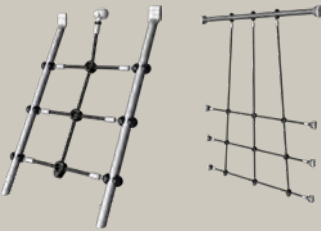

### Activity panels and talk tubes



### Balconies and bridges



### Roofs

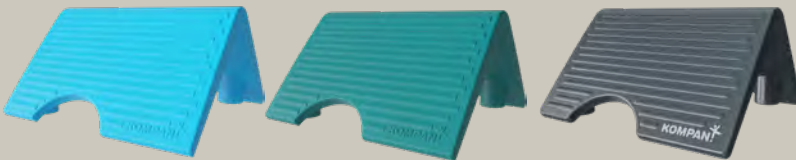

Moulded PE (one piece)

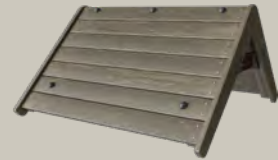

Impregnated and painted brown pine wood boards

### Posts



Steel

Black aluminium

Pine wood

TexMade™

#### Steel colors



TexMade™ posts for the lowest possible carbon emissions factor are available for all versions of the play system.

## More flexibility

Contact us for more information on the wide range of options for configurable playground equipment. Please note that prices and delivery terms depend on specified configurations.



# MOMENTS™ PRESCHOOL

## Play it Your Way with Moments™ Play System

The Moments™ Play System allows you to create a play solution that reflects your ideas. The elevated playhouses give young children a sense of thrill, and being above ground level trains the child's spatial awareness.

Choose between various play activities and material options and your play vision can soon become a reality.

See options on the FLEXIBILITY page.



Play Tower with ADA Stairs  
PCM100131



Play Tower with Climbing Net  
PCM100331



Large Play Tower with Curly climber  
PCM100231



### For a greener future

#### Post-consumer recycled materials:

EcoCore™ Panels	>95%
Hollow Plastic Parts	33%
Hercules Rope Yarn	>95%
Molded Decks	75%
TexMade™ Posts	>95%

Extruded aluminium made with low-carbon aluminium  
Steel parts adhere to industrial standards



Play Tower with Curly Climber & Net  
PCM100431



Double Tower w/ Bridge & Climber  
PCM200231



Large Play Tower with curved Slide  
PCM103731



Double Tower with Bridge  
PCM200131



Small Slide Tower  
PCM104331



Medium Slide Tower  
PCM104431



Large Slide Tower  
PCM104531

## PRODUCT INFORMATION

Emission: Standard version / Greenest version

Product number	Product name	Age (years)	Capacity (users)	Fall height (ft & in)	Total height (ft & in)	Use zone dimensions (ft <sup>2</sup> )	Use zone dimensions (ft & in x ft & in)	Installation (hours)	Total CO <sub>2</sub> e (kg CO <sub>2</sub> e)
PCM100131	Play Tower with ADA Stairs	2 - 5	7	2'11"	7'3"	343	25'6" x 16'1"	13	564 / 477
PCM100331	Play Tower with Climbing Net	2 - 5	12	7'4"	7'7"	468	28'4" x 22'9"	17	937 / -
PCM100231	Large Play Tower with Curly climber	2 - 5	14	6'8"	9'2"	452	25'9" x 24'6"	18	984 / 813
PCM100431	Play Tower with Curly Climber & Net	2 - 5	20	7'4"	9'2"	535	32'7" x 23'10"	21	1,227 / 1,051
PCM200231	Double Tower w/ Bridge & Climber	2 - 5	11	3'3"	7'3"	452	31'7" x 17'3"	19	910 / 752
PCM103731	Large Play Tower with curved Slide	2 - 5	21	3'10"	8'3"	453	28'3" x 22'12"	22	1,005 / 879
PCM200131	Double Tower with Bridge	2 - 5	17	4'6"	8'3"	539	31'4" x 23'9"	22	1,182 / 989
PCM104331	Small Slide Tower	2 - 5	5	3'10"	6'7"	378	25'2" x 21'6"	12	611 / 505
PCM104431	Medium Slide Tower	2 - 5	4	2'11"	5'7"	325	24'6" x 15'11"	10	521 / 418
PCM104531	Large Slide Tower	2 - 5	6	3'10"	6'7"	403	28'8" x 16'8"	13	704 / 587





Angled double Tower with ADA Stairs  
**PCM201931**



Double Tower with Slides  
**PCM200331**



Angled double Tower with U-Net  
**PCM202031**



Triple Tower with Bridge  
**PCM300131**



Angled triple Tower with U-Net  
**PCM301231**



Four Towers  
**PCM400131**

**PRODUCT INFORMATION**

Emission: Standard version / Greenest version

Product number	Product name	Age (years)	Capacity (users)	Fall height (ft & in)	Total height (ft & in)	Use zone dimensions (ft <sup>2</sup> )	Use zone dimensions (ft & in x ft & in)	Installation (hours)	Total CO <sub>2</sub> e (kg CO <sub>2</sub> e)
<b>PCM201931</b>	Angled double Tower with ADA Stairs	2 - 5	24	6'8"	9'2"	577	28'5" x 26'3"	26	1,465 / 1,262
<b>PCM200331</b>	Double Tower with Slides	2 - 5	23	6'8"	9'2"	657	27'4" x 32'7"	27	1,470 / 1,221
<b>PCM202031</b>	Angled double Tower with U-Net	2 - 5	26	6'8"	9'2"	707	29'6" x 33'7"	29	1,710 / 1,453
<b>PCM300131</b>	Triple Tower with Bridge	2 - 5	27	6'8"	9'2"	757	39'8" x 26'4"	31	1,819 / 1,528
<b>PCM301231</b>	Angled triple Tower with U-Net	2 - 5	35	6'8"	9'2"	775	36'9" x 26'3"	31	1,919 / 1,651
<b>PCM400131</b>	Four Towers	2 - 5	43	7'4"	9'2"	828	40'8" x 28'2"	38	2,370 / 1,939



# MOMENTS™ PRESCHOOL



Triple Mega Deck with Towers  
PCM301331



Mega Deck  
PCM100931



Mega Deck with Roof  
PCM100831



Double Mega Deck with Tower  
PCM200431



Mega Deck with Shade  
PCM103831

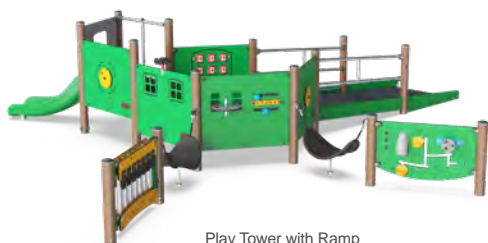

Play Tower with Ramp  
PCM103031



Triple Tower with Ramps  
PCM301131

## PRODUCT INFORMATION

Emission: Standard version / Greenest version

Product number	Product name	Age (years)	Capacity (users)	Fall height (ft & in)	Total height (ft & in)	Use zone dimensions (ft <sup>2</sup> )	Use zone dimensions (ft & in x ft & in)	Installation (hours)	Total CO <sub>2</sub> e (kg CO <sub>2</sub> e)
PCM301331	Triple Mega Deck with Towers	2 - 5	47	6'8"	11'6"	885	35'9" x 35'11"	51	2,669 / 2,291
PCM100931	Mega Deck	2 - 5	14	2'11"	10'6"	522	27'6" x 26'10"	18	987 / 861
PCM100831	Mega Deck with Roof	2 - 5	19	6'8"	10'6"	502	27'10" x 25'2"	23	1,420 / 1,228
PCM200431	Double Mega Deck with Tower	2 - 5	36	6'8"	10'6"	664	33'0" x 29'0"	33	2,009 / 1,703
PCM103831	Mega Deck with Shade	2 - 5	19	6'8"	14'5"	502	27'10" x 25'2"	23	1,601 / 1,370
PCM103031	Play Tower with Ramp	2 - 5	34	2'11"	4'7"	703	34'9" x 32'7"	24	1,460 / -
PCM301131	Triple Tower with Ramps	2 - 5	63	6'8"	9'2"	1295	43'4" x 43'11"	61	4,024 / 3,714





Sandworks  
PCM103931



Sand Gravel Pit  
PCM104131



Sand Creator  
PCM104031



Double Tower with Sand Play  
PCM202631



## PRODUCT INFORMATION

Emission: Standard version / Greenest version

Product number	Product name	Age (years)	Capacity (users)	Fall height (ft & in)	Total height (ft & in)	Use zone dimensions (ft <sup>2</sup> )	Use zone dimensions (ft & in x ft & in)	Installation (hours)	Total CO <sub>2</sub> e (kg CO <sub>2</sub> e)
PCM103931	Sandworks	2 - 5	10	1'7"	7'1"	314	20'4" x 20'9"	10	526 / 441
PCM104131	Sand Gravel Pit	2 - 5	24	2'11"	9'6"	382	23'9" x 22'7"	19	1,006 / 892
PCM104031	Sand Creator	2 - 5	16	2'3"	7'1"	361	23'5" x 19'11"	15	717 / 620
PCM202631	Double Tower with Sand Play	2 - 5	24	7'4"	9'2"	577	38'1" x 21'2"	26	1,481 / 1,252



# FLEXIBILITY

With a variety of colors and part options, we offer lots of flexibility and customization with our standard products.



Beige



Orange



Blue



Green



Red



Lime



Teal



Interlinked Product Solution

## Greenest version

Is fitted with TexMade™ posts as the standard option, making it the version with the lowest possible carbon emissions factor. TexMade™ posts can also be selected for the other color versions.





## Integrated shading options

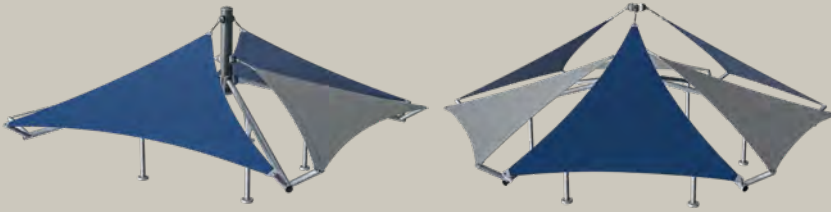

## Single and double PE slides



PE slide colors



## Stainless steel slides and activities

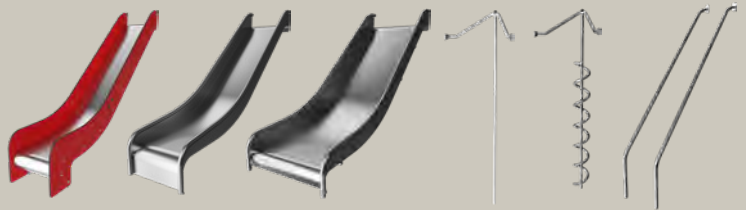

NOTE:

Steel slides heated by the midday sun can cause severe skin burns. We recommend pointing steel slides away from the midday sun or using PE slides or shading.

## Angled climbing, podium or staircase access points



## Activity panels

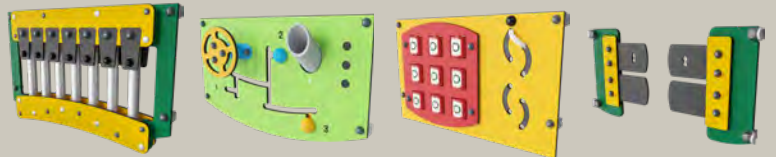

## Bridge, tunnels and climbing nets

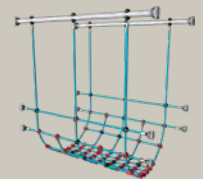
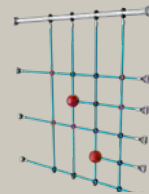
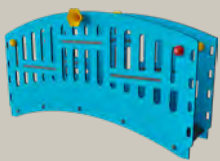

## Posts



Steel



Black aluminium



Pine wood



TexMade™

TexMade™ posts for the lowest possible carbon emissions factor are available for all versions of the play system.

Steel colors



## More flexibility

Contact us for more information on the wide range of options for configurable playground equipment. Please note that prices and delivery terms depend on specified configurations.



# MOMENTS™ SCHOOL-AGE

## Moments™ Play System

This unique play system provides appropriate play activities for school-age children. It contains optional standard products, such as slides, swings, and challenging deck play structures, which enable you to design the perfect structure for your needs and wants.

With scalable design options, this solution's flexibility is suitable for any playground environment.

See options on the FLEXIBILITY page.



Double Towers with Net Bridge  
PCM211231



Embankment Slide  
PCM110121



Embankment Slide, wide  
PCM110221



Play Tower with Curved Slide  
PCM112131



Double Tower Wackler  
PCM211331



Play Tower with Slides  
PCM114231



Two Tower with Slides  
PCM212931



Two Tower with Bridge  
PCM213031



Small Slide Tower  
PCM114531



Medium Slide Tower  
PCM114631



Large Slide Tower  
PCM114731



**For a greener future**  
Post-consumer recycled materials:

EcoCore™ Panels	>95%
Hollow Plastic Parts	33%
Hercules Rope Yarn	>95%
Molded Decks	75%
TexMade™ Posts	>95%

Extruded aluminium made with low-carbon aluminium  
Steel parts adhere to industrial standards

### PRODUCT INFORMATION

Emission: Standard version / Greenest version

Product number	Product name	Age (years)	Capacity (users)	Fall height (ft & in)	Total height (ft & in)	Use zone dimensions (ft²)	Use zone dimensions (ft & in x ft & in)	Installation (hours)	Total CO <sub>2</sub> e (kg CO <sub>2</sub> e)
PCM211231	Double Towers with Net Bridge	5 - 12	21	7'4"	12'6"	666	33'6" x 24'5"	22	1,559 / 1,306
PCM110121	Embankment Slide	5 - 12	3	3'4"	3'7"	141	22'12" x 13'12"	11	394 / 354
PCM110221	Embankment Slide, wide	5 - 12	3	3'4"	3'7"	108	19'3" x 14'5"	6	501 / 470
PCM112131	Play Tower with Curved Slide	5 - 12	12	6'9"	10'2"	483	25'10" x 26'7"	22	1,107 / 931
PCM211331	Double Tower Wackler	5 - 12	14	6'10"	8'6"	659	31'8" x 27'11"	21	1,325 / 1,127
PCM114231	Play Tower with Slides	2 - 12	11	4'10"	12'6"	532	25'9" x 29'6"	21	1,151 / 934
PCM212931	Two Tower with Slides	2 - 12	18	6'10"	13'6"	801	33'10" x 31'3"	28	1,812 / 1,511
PCM213031	Two Tower with Bridge	2 - 12	20	7'3"	13'6"	780	40'5" x 31'4"	33	2,073 / 1,705
PCM114531	Small Slide Tower	5 - 12	6	5'10"	9'3"	457	27'7" x 24'7"	14	815 / 678
PCM114631	Medium Slide Tower	5 - 12	4	4'10"	8'4"	399	29'8" x 15'11"	14	763 / 632
PCM114731	Large Slide Tower	5 - 12	6	5'10"	13'5"	487	34'2" x 17'8"	17	1,027 / 832





PATENTED

Cliff Rider  
PCM212731



Track Ride Tower  
PCM111531



Triple Tower with Turbo  
PCM310531



Play Tower Overhead  
PCM111631



Double Tower with Turbo  
PCM211431

**PRODUCT INFORMATION**

Emission: Standard version / Greenest version

Product number	Product name	Age (years)	Capacity (users)	Fall height (ft & in)	Total height (ft & in)	Use zone dimensions (ft <sup>2</sup> )	Use zone dimensions (ft & in x ft & in)	Installation (hours)	Total CO <sub>2</sub> e (kg CO <sub>2</sub> e)
PCM212731	Cliff Rider	5 - 12	11	6'11"	12'0"	395	15'11" x 30'1"	21	1,351 / -
PCM111531	Track Ride Tower	5 - 12	5	6'6"	7'7"	512	32'8" x 21'5"	10	708 / -
PCM310531	Triple Tower with Turbo	5 - 12	24	7'4"	10'7"	756	33'2" x 32'8"	20	1,622 / -
PCM111631	Play Tower Overhead	5 - 12	17	6'8"	11'6"	579	31'8" x 22'4"	20	1,366 / 1,151
PCM211431	Double Tower with Turbo	5 - 12	14	6'9"	12'6"	530	29'8" x 24'10"	21	1,401 / 1,212



# MOMENTS™ SCHOOL-AGE



Four Towers with Bridges  
PCM410331



Triple Tower with Net  
PCM310331



Triple Tower with Track  
PCM310431



Double Tower Ladder  
PCM211931



Four Towers with Net  
PCM410231



Six Tower Mega Deck  
PCM610131

## PRODUCT INFORMATION

Emission: Standard version / Greenest version

Product number	Product name	Age (years)	Capacity (users)	Fall height (ft & in)	Total height (ft & in)	Use zone dimensions (ft <sup>2</sup> )	Use zone dimensions (ft & in x ft & in)	Installation (hours)	Total CO <sub>2</sub> e (kg CO <sub>2</sub> e)
PCM410331	Four Towers with Bridges	5 - 12	36	9'4"	12'6"	1052	35'4" x 41'1"	41	2,942 / 2,477
PCM310331	Triple Tower with Net	5 - 12	27	9'4"	13'6"	713	35'6" x 27'7"	33	2,105 / 1,775
PCM310431	Triple Tower with Track	5 - 12	28	6'8"	13'5"	1138	46'9" x 41'0"	39	2,630 / 2,393
PCM211931	Double Tower Ladder	5 - 12	18	7'10"	13'6"	744	27'11" x 37'12"	29	2,095 / 1,733
PCM410231	Four Towers with Net	5 - 12	26	7'4"	12'6"	950	40'4" x 37'11"	33	2,452 / 2,012
PCM610131	Six Tower Mega Deck	5 - 12	66	9'10"	15'5"	1624	52'5" x 46'11"	84	5,911 / 4,966





Mega Deck with Ladder  
PCM111731



Mega Deck Upper Deck  
PCM111831



Triple Tower Shading  
PCM311231



Double Mega Deck  
PCM310731



Triple Tower Wackle  
PCM310631

## PRODUCT INFORMATION

Emission: Standard version / Greenest version

Product number	Product name	Age (years)	Capacity (users)	Fall height (ft & in)	Total height (ft & in)	Use zone dimensions (ft <sup>2</sup> )	Use zone dimensions (ft & in x ft & in)	Installation (hours)	Total CO <sub>2</sub> e (kg CO <sub>2</sub> e)
PCM111731	Mega Deck with Ladder	5 - 12	20	7'10"	9'6"	694	29'9" x 29'2"	27	1,610 / 1,400
PCM111831	Mega Deck Upper Deck	5 - 12	29	9'10"	15'5"	649	33'6" x 27'9"	34	2,183 / 1,889
PCM311231	Triple Tower Shading	5 - 12	36	7'10"	16'3"	902	40'2" x 29'5"	40	2,791 / 2,283
PCM310731	Double Mega Deck	5 - 12	47	9'10"	15'5"	1467	46'2" x 49'2"	66	4,494 / 3,906
PCM310631	Triple Tower Wackle	5 - 12	28	9'1"	13'5"	913	40'2" x 28'7"	42	2,704 / 2,248



# FLEXIBILITY

With a variety of colors and part options, we offer lots of flexibility and customization with our standard products.



Beige



Orange



Blue



Green



Red



Lime



Teal

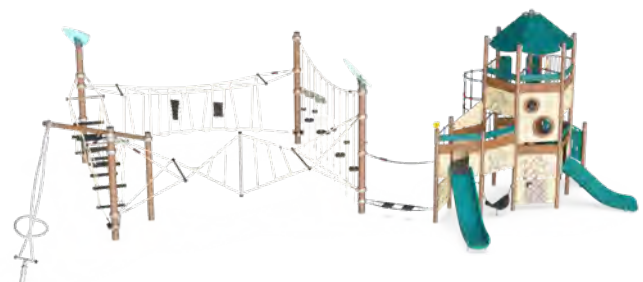

Interlinked Product Solution

## Greenest version

Is fitted with TexMade™ posts as the standard option, making it the version with the lowest possible carbon emissions factor. TexMade™ posts can also be selected for the other color versions.





Anti-climb panels



Integrated shading options

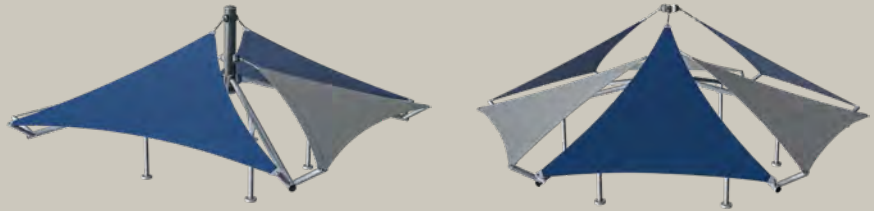

PE slides

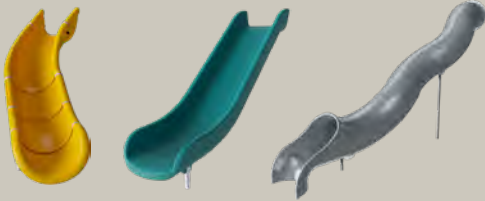

PE slide colors



Stainless steel slides and activities

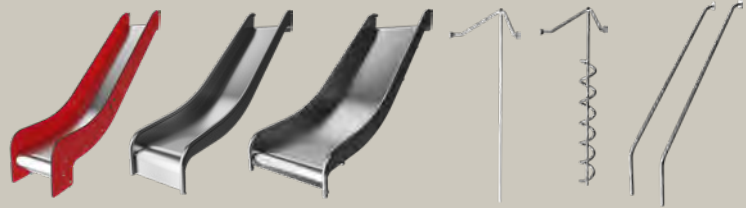

NOTE:

Steel slides heated by the midday sun can cause severe skin burns. We recommend pointing steel slides away from the midday sun or using PE slides or shading.

Tunnels, bridges and climbing nets

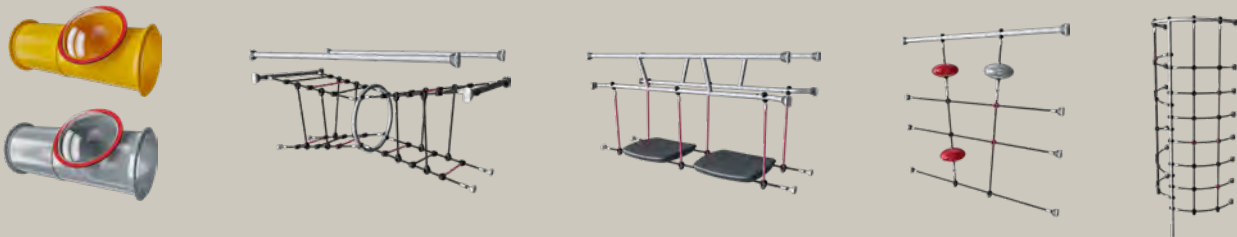

Climbing and activity panels

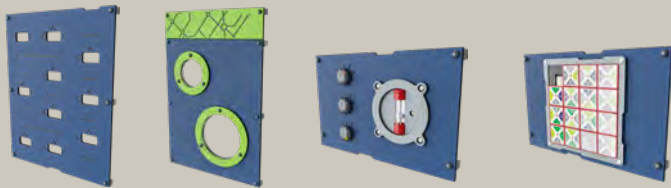

Posts



Steel

Black aluminium

Pine wood

TexMade™

Steel colors



TexMade™ posts for the lowest possible carbon emissions factor are available for all versions of the play system.

## More flexibility

Contact us for more information on the wide range of options for configurable playground equipment. Please note that prices and delivery terms depend on specified configurations.



# MOMENTS™ HERCULES

## Pre-school play fit for inner cities

MOMENTS™ HERCULES is a rock-solid and fun play experience for pre-school children. The materials used in this product line are carefully selected to provide a long lifespan and are highly vandalism-resistant, making this solution ideal for a city's unsupervised areas.

The play activities within MOMENTS™ HERCULES pre-school stimulate the pre-schooler's instinct to play through a range of traditional play activities, like sliding, gliding, climbing, and the exploration of cognitive elements.

The many ground-level activities and low entry points of the structures make MOMENTS™ HERCULES highly inclusive ensuring play for all users.



Brooklyn Mega Deck  
PCX2001



### For a greener future

#### Post-consumer recycled materials:

EcoCore™ Panels

>95%

Extruded aluminium made with low-carbon aluminium  
Steel parts adhere to industrial standards



Bronx Mega Deck  
PCX1001



Bryant Play & Stay  
PCX0001



Holland Play & Stay  
PCX0002



Lincoln Play & Stay  
PCX0003



Liberty Play Hammock  
PCX801

## PRODUCT INFORMATION

Product number	Product name	Age (years)	Capacity (users)	Fall height (ft & in)	Total height (ft & in)	Use zone dimensions (ft²)	Use zone dimensions (ft & in x ft & in)	Installation (hours)	Total CO <sub>2</sub> e (kg CO <sub>2</sub> e)
PCX2001	Brooklyn Mega Deck	2 - 5	36	6'8"	11'9"	884	38'5" x 33'2"	36	4,281
PCX1001	Bronx Mega Deck	2 - 5	20	6'8"	11'9"	587	30'7" x 29'4"	25	3,102
PCX0001	Bryant Play & Stay	2 - 5	10	0'0"	3'7"	-	0'0" x 0'0"	4.3	409
PCX0002	Holland Play & Stay	2 - 5	4	2'1"	3'7"	314	21'10" x 18'5"	7.6	767
PCX0003	Lincoln Play & Stay	2 - 5	10	1'3"	3'7"	384	27'2" x 19'6"	8.4	923
PCX801	Liberty Play Hammock	2 - 12	1	1'4"	3'3"	211	15'11" x 15'11"	3.2	185





Manhattan Mega Deck  
PCX3001



Triborough Triple Mega Deck  
PCX3002

## PRODUCT INFORMATION

Product number	Product name	Age (years)	Capacity (users)	Fall height (ft & in)	Total height (ft & in)	Use zone dimensions (ft <sup>2</sup> )	Use zone dimensions (ft & in x ft & in)	Installation (hours)	Total CO <sub>2</sub> e (kg CO <sub>2</sub> e)
PCX3001	Manhattan Mega Deck	2 - 5	48	6'8"	11'9"	1057	37'6" x 37'9"	48	5,984
PCX3002	Triborough Triple Mega Deck	2 - 5	48	6'8"	9'9"	1270	45'8" x 42'8"	65	8,472



# MOMENTS™ HERCULES



Queensboro Play & Agility Tower  
PCX2102



Chelsea Overhead Ladder  
PCX802

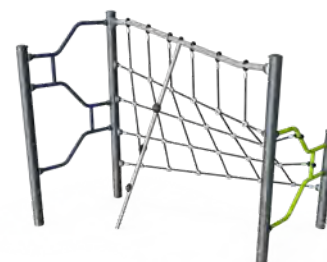

Soho Twisted Net  
PCX803



Van Cortlandt Play & Agility Tower  
PCX2101



Tribeca Agility Station  
PCX804



Madison Square Double Meeting Point  
PCX701

## PRODUCT INFORMATION

Product number	Product name	Age (years)	Capacity (users)	Fall height (ft & in)	Total height (ft & in)	Use zone dimensions (ft <sup>2</sup> )	Use zone dimensions (ft & in x ft & in)	Installation (hours)	Total CO <sub>2</sub> e (kg CO <sub>2</sub> e)
PCX2102	Queensboro Play & Agility Tower	5 - 12	52	8'7"	14'5"	1082	41'7" x 33'5"	41	4,991
PCX802	Chelsea Overhead Ladder	5 - 12	4	6'1"	6'8"	272	15'11" x 19'5"	4.1	300
PCX803	Soho Twisted Net	5 - 12	8	6'12"	7'4"	282	19'5" x 19'5"	5.8	372
PCX2101	Van Cortlandt Play & Agility Tower	5 - 12	34	6'10"	12'8"	724	29'9" x 33'9"	27	3,234
PCX804	Tribeca Agility Station	5 - 12	6	7'6"	7'12"	255	15'11" x 19'5"	5.1	392
PCX701	Madison Square Double Meeting Point	5 - 12	4	1'4"	5'8"	287	22'9" x 15'9"	6.6	677





High Line Double Mega Deck Combination  
PCX5101



Greenbelt Play & Agility Tower  
PCX4101

## PRODUCT INFORMATION

Product number	Product name	Age (years)	Capacity (users)	Fall height (ft & in)	Total height (ft & in)	Use zone dimensions (ft²)	Use zone dimensions (ft & in x ft & in)	Installation (hours)	Total CO <sub>2</sub> e (kg CO <sub>2</sub> e)
PCX5101	High Line Double Mega Deck Combination	5 - 12	90	8'7"	14'6"	2217	59'0" x 58'8"	111	15,576
PCX4101	Greenbelt Play & Agility Tower	5 - 12	58	7'12"	16'5"	1399	46'11" x 46'10"	56	7,933



# FLEXIBILITY

With a variety of colors and part options, we offer lots of flexibility and customization with our standard products.



Nature



Classic



Modern



# OPTIONS

Straight, wide and curved stainless steel slides

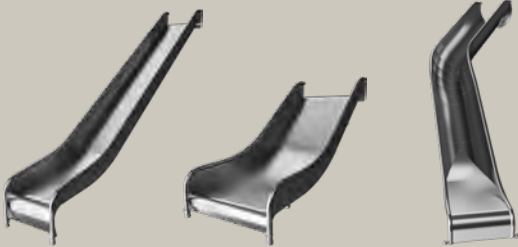

Multiple egress, access and agility options

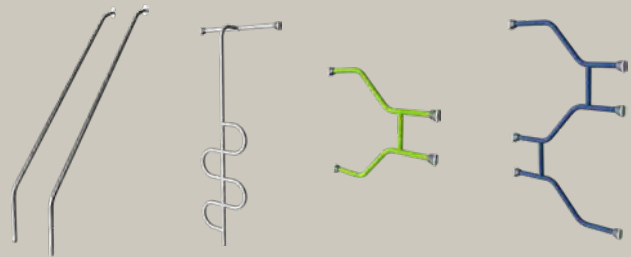

NOTE:  
Steel slides heated by the midday sun can cause severe skin burns.

Play panels

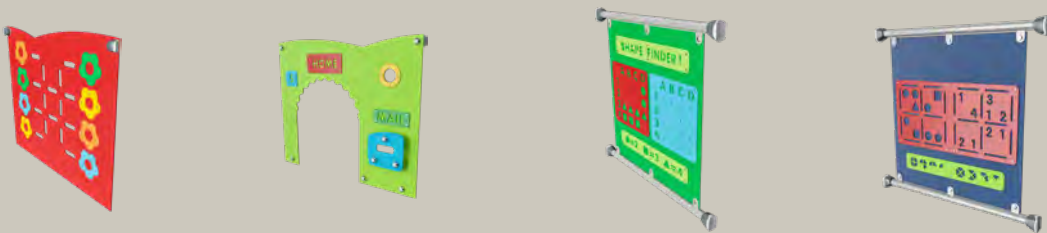

Color schemes

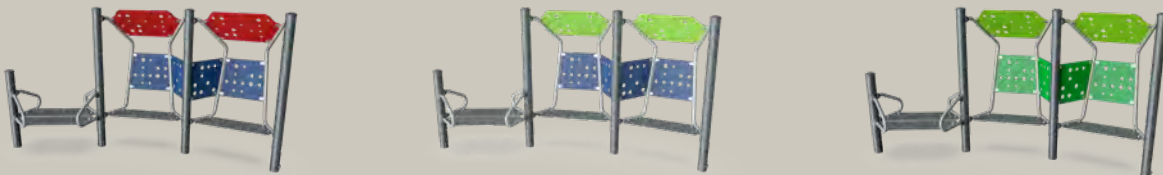

## More flexibility

Contact us for more information on the wide range of options for configurable playground equipment. Please note that prices and delivery terms depend on specified configurations.



# KOMPAN Ramp Solutions

## Play solutions for all

To create equity in public play is a main obligation of our communities. This implies equal access to playgrounds for all citizens, including children or parents with differing abilities. For some playgrounds, ramps are the best solution to provide accessibility and usability.

KOMPAN ramp solutions let children and adults in wheelchairs participate in play

by giving them a free pathway into and around in the play structure. Along the path, they find interactive play activities placed at an appropriate height before finishing off at the top of the structure with a rare view from above. The path through and around the ramp structure is paved with joyful and educational play activities for all children of all abilities

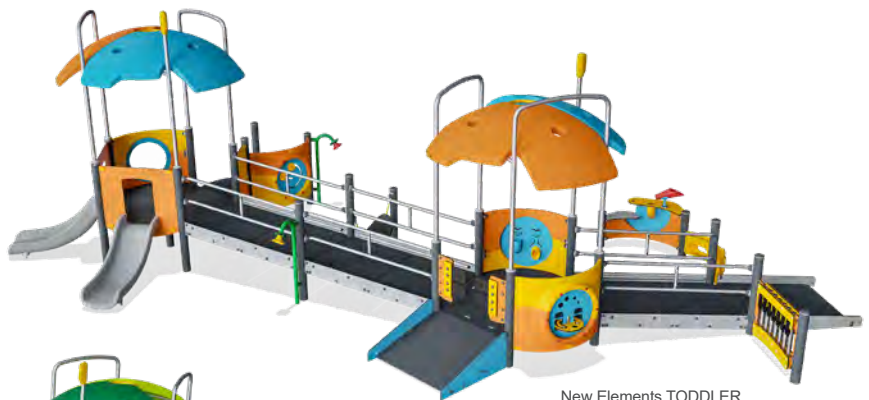

New Elements TODDLER  
PCE200531



New Elements GROW  
PCE305121

### STANDARD RAMP SOLUTIONS

NEW ELEMENTS integrated ramp system. High play value and very high level of physical play for all age groups. See page 132-137 for more product information.



New Elements GO  
PCE610431





Triple Tower with ramps  
PCM301131

### STANDARD RAMP SOLUTIONS

MOMENTS™ ramp solutions for inclusive play.  
See page 112 for more product information.



Play Tower with Ramp  
PCM103031



MOMENTS Hercules Preschool  
PCX3002

### STANDARD RAMP SOLUTIONS

MOMENTS™ HERCULES ramp solutions  
for inclusive play. See page 122-125 for more  
product information.



MOMENTS Hercules School Age  
PCX5101

## A LOOP OF PLAY

KOMPAN ramp solutions offer a wide variety of gross and fine motor play events that can be used from the inside and the outside of the structure. There is a rich range of auditory and manipulative play

elements. The play can take place in and on the ramped structure as well as on the outside of the structure, welcoming all users. The layout of the ramp structure generates a loop of play, allowing for

access to the elevated platform through a ramp as well as an inclined boarding net that allows several users to access at the same time.



# KOMPAN Shading Solutions

## Children should only worry about play

When playing outdoors on sunny days, children need protection from the harmful rays of the sun.

A KOMPAN shading solution is an easy and secure way to do just that. The integrated sails provides a large shaded area that

slowly moves over the play structure and areas around it. By reducing the intense heat on the hottest of days, the children are safe from sun fatigue and happily play for longer.

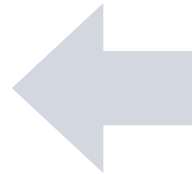

### CUSTOMIZED SOLUTIONS

The sails can be added to Moments™ and Elements™ Play Systems. Please contact us for further guidance and information.

## Shade material

Sails are manufactured from Commercial 95 High Density Polyethylene (HDPE), a knitted shade cloth manufactured solely for tensioned sunshade structures.

The material is then treated with UV stabilizers to give it a very long life in direct sunlight. KOMPAN shades will not rot or fray,

and the high quality lock-stitch construction gives superior tear strength. The shade sails are only constructed from commercial grade knitted shade-cloth with up to 96% UV block. In light rain, the water will run off to the lowest point, but the water will drain through the fiber in a heavier downpour.

## Open integrated shading

Shade solutions consisting of four or six individual sails placed in different layers are available for the large square deck and the Mega Deck platform for Moments™ and Elements™ play systems.

CHOOSE BETWEEN 6 DIFFERENT COLORS:

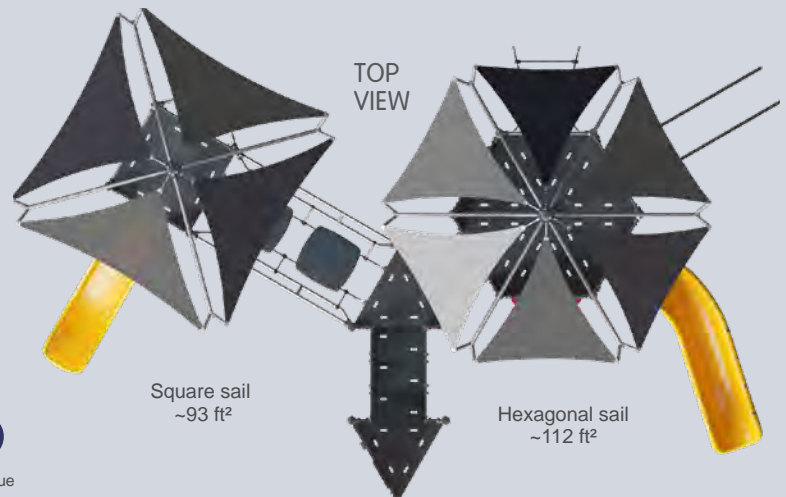



# Fully closed Shades

## Maximize protected area

Closed one-piece shades ensures full coverage of the shaded area below the integrated shade.

The shades are attached to the steel frame in each corner and tensioned by a pully system.



## Shade material

This architectural shade cloth is a heavy-weight, lock-stitched knitted HDPE fabric designed specifically for tension structures. We only use PTFE (Teflon®) thread with a minimum of 2000 denier, which does not deteriorate from exposure to the elements, including UV radiation!

In high stress areas like the corners of the shade, we add internal webbing reinforcements with extra layers of fabric. All cable pockets are double folded, and stainless-steel plates are sewn into the fabric corners to prevent fabric from ripping out. A truly outdoor-proof shade solution designed to last for many years.

## Closed integrated shading

These integrated shades are available for all deck shapes and sizes within Moments™ and Elements™ play systems.

CHOOSE BETWEEN 6 DIFFERENT COLORS:

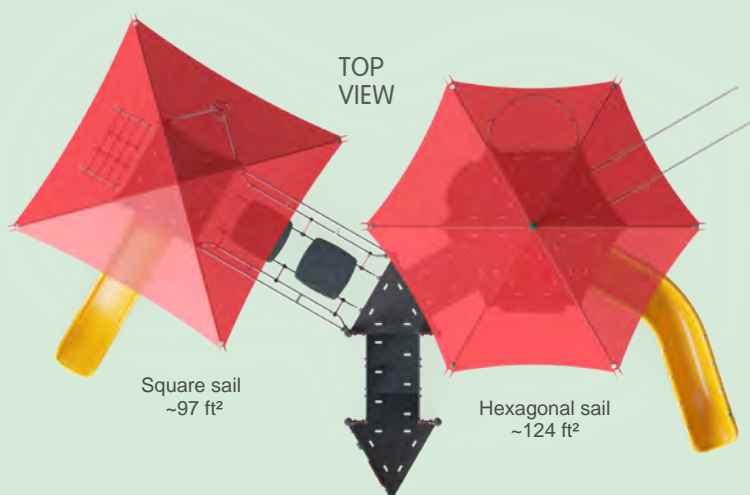



# ELEMENTS™ TODDLER

## Responsive Play for the Youngest

Physical play is essential in fostering child development. The Elements™ Toddler series provides a safe world of play activities for the youngest. Responsive play activities stimulate the child's motor skills and gently push toddlers to explore and learn through play.

Playing on the Elements™ Toddler series helps toddlers develop skills to prepare them for kindergarten, school, and life.

See options on the FLEXIBILITY page.



Tumbler  
PCE200231



### For a greener future

#### Post-consumer recycled materials:

EcoCore™ Panels	>95%
Hollow Plastic Parts	33%
Hercules Rope Yarn	>95%
Molded Decks	75%

Extruded aluminium made with low-carbon aluminium  
Steel parts adhere to industrial standards



Globetrotter  
PCE200431



Voyager  
PCE100131



Jetsetter with Shade  
PCE100331



Pioneer  
PCE200531

## PRODUCT INFORMATION

Product number	Product name	Age (years)	Capacity (users)	Fall height (ft & in)	Total height (ft & in)	Use zone dimensions (ft²)	Use zone dimensions (ft & in x ft & in)	Installation (hours)	Total CO <sub>2</sub> e (kg CO <sub>2</sub> e)
PCE200231	Tumbler	6m - 2	28	1'11"	10'8"	605	29'10" x 26'10"	27	1,600
PCE200431	Globetrotter	6m - 2	30	1'11"	11'1"	710	33'6" x 28'6"	31	1,869
PCE100131	Voyager	6m - 2	15	1'11"	11'3"	370	23'5" x 21'9"	17	876
PCE100331	Jetsetter with Shade	6m - 2	17	1'11"	11'10"	370	23'5" x 21'8"	18	1,030
PCE200531	Pioneer	6m - 2	44	1'11"	11'2"	899	45'8" x 27'7"	42	2,962





Adventurer  
PCE400231

## PRODUCT INFORMATION

Product number	Product name	Age (years)	Capacity (users)	Fall height (ft & in)	Total height (ft & in)	Use zone dimensions (ft <sup>2</sup> )	Use zone dimensions (ft & in x ft & in)	Installation (hours)	Total CO <sub>2</sub> e (kg CO <sub>2</sub> e)
PCE400231	Adventurer	6m - 2	53	1'11"	11'2"	933	34'3" x 34'5"	49	3,109



# ELEMENTS™ GROW

## Agile and Exploratory Play

Elements™ Grow is a world of agile and exploratory play activities that enhance children’s holistic development. Playing on these structures, children face age-appropriate physical challenges that gently push their boundaries and help them grow.

The physical challenges develop the child’s motor skills, helping the child become self-confident when playing with friends and exploring the world.

See options on the FLEXIBILITY page.



Mountaineer  
PCE205221



### For a greener future

#### Post-consumer recycled materials:

EcoCore™ Panels	>95%
Hollow Plastic Parts	33%
Hercules Rope Yarn	>95%
Molded Decks	75%

Extruded aluminium made with low-carbon aluminium  
Steel parts adhere to industrial standards



Rider  
PCE50121



Miner  
PCE50221



Trader  
PCE50321



Rambler  
PCE105431



Trendsetter  
PCE205531



Jumper  
PCE205031



Runner  
PCE205131



Discoverer  
PCE405031



Sherpa  
PCE105131



Originator  
PCE105221

## PRODUCT INFORMATION

Product number	Product name	Age (years)	Capacity (users)	Fall height (ft & in)	Total height (ft & in)	Use zone dimensions (ft²)	Use zone dimensions (ft & in x ft & in)	Installation (hours)	Total CO <sub>2</sub> e (kg CO <sub>2</sub> e)
PCE205221	Mountaineer	2 - 5	35	6'8"	13'5"	816	36'3" x 30'1"	34	2,601
PCE50121	Rider	2 - 5	9	0'12"	7'9"	252	17'11" x 17'11"	6.6	373
PCE50221	Miner	2 - 5	3	0'0"	6'11"	-	0'0" x 0'0"	4.8	118
PCE50321	Trader	2 - 5	6	0'0"	9'11"	-	0'0" x 0'0"	7.5	328
PCE105431	Rambler	2 - 5	23	6'8"	14'10"	601	27'5" x 29'10"	22	1,552
PCE205531	Trendsetter	2 - 5	23	6'8"	13'9"	594	31'12" x 26'5"	25	1,742
PCE205031	Jumper	2 - 5	30	1'11"	10'8"	622	29'10" x 27'3"	27	1,708
PCE205131	Runner	2 - 5	32	1'11"	11'2"	735	33'3" x 30'0"	33	2,066
PCE405031	Discoverer	2 - 5	55	1'11"	11'2"	961	34'11" x 34'6"	50	3,182
PCE105131	Sherpa	2 - 5	13	6'8"	14'12"	457	27'1" x 24'3"	17	1,140
PCE105221	Originator	2 - 5	23	6'8"	14'10"	534	30'4" x 25'12"	27	1,702





Creator  
PCE305021



Hiker  
PCE405121



Maker with Shade  
PCE205621



Pathfinder  
PCE305121

## PRODUCT INFORMATION

Product number	Product name	Age (years)	Capacity (users)	Fall height (ft & in)	Total height (ft & in)	Use zone dimensions (ft <sup>2</sup> )	Use zone dimensions (ft & in x ft & in)	Installation (hours)	Total CO <sub>2</sub> e (kg CO <sub>2</sub> e)
PCE305021	Creator	2 - 5	32	5'5"	5'8"	879	39'1" x 32'9"	28	1,939
PCE405121	Hiker	2 - 5	53	6'8"	14'10"	1210	39'6" x 42'7"	57	4,150
PCE205621	Maker with Shade	2 - 5	35	6'8"	13'1"	816	36'3" x 30'1"	32	2,567
PCE305121	Pathfinder	2 - 5	66	6'8"	13'1"	1320	50'2" x 40'12"	62	4,548



# ELEMENTS™ GO

## Free Play with No Instructions

Elements™ Go is a series inspired by children and their innovative and creative approach to play. Observing how they climb on the exterior surfaces of regular post-and-platform playgrounds in search of new challenges inspired us to create structures to enhance this curiosity.

Children are inherently curious and masters of innovation. Thankfully, playgrounds don't come with play instructions.

See options on the FLEXIBILITY page.



Rainer  
PCE210531



Olympus  
PCE210731



Matterhorn  
PCE110631



Logan  
PCE111131



Colorado with Shade  
PCE111331



Fuji  
PCE110931



Ayers Rock  
PCE110731



Silberhorn  
PCE110831



Mont Blanc  
PCE210631



Kilimanjaro  
PCE310231

### For a greener future

#### Post-consumer recycled materials:

EcoCore™ Panels	>95%
Hollow Plastic Parts	33%
Hercules Rope Yarn	>95%
Molded Decks	75%

Extruded aluminium made with low-carbon aluminium  
Steel parts adhere to industrial standards

## PRODUCT INFORMATION

Product number	Product name	Age (years)	Capacity (users)	Fall height (ft & in)	Total height (ft & in)	Use zone dimensions (ft²)	Use zone dimensions (ft & in x ft & in)	Installation (hours)	Total CO <sub>2</sub> e (kg CO <sub>2</sub> e)
PCE210531	Rainer	5 - 12	23	7'10"	18'9"	876	35'4" x 32'12"	40	2,524
PCE210731	Olympus	5 - 12	22	7'12"	13'5"	797	38'3" x 32'12"	23	2,183
PCE110631	Matterhorn	5 - 12	10	7'10"	12'7"	439	23'12" x 26'4"	18	1,225
PCE111131	Logan	5 - 12	14	5'10"	13'11"	534	29'4" x 25'11"	24	1,414
PCE111331	Colorado with Shade	5 - 12	22	5'10"	15'9"	738	34'9" x 32'0"	32	2,318
PCE110931	Fuji	5 - 12	40	9'1"	19'1"	1055	41'10" x 35'11"	51	5,052
PCE110731	Ayers Rock	5 - 12	25	7'3"	15'11"	738	34'8" x 32'0"	30	2,198
PCE110831	Silberhorn	5 - 12	32	7'10"	18'9"	1015	35'4" x 40'9"	49	3,297
PCE210631	Mont Blanc	5 - 12	37	7'10"	18'9"	1297	47'6" x 46'2"	56	4,329
PCE310231	Kilimanjaro	5 - 12	50	9'1"	19'3"	1369	56'5" x 40'7"	62	6,317





Elements Cliff Rider  
PCE112531



Cliff Rider Extreme  
PCE211731



Cliff Rider Ultimate  
PCE310531



McKinley  
PCE610331



Everest  
PCE610431

## PRODUCT INFORMATION

Product number	Product name	Age (years)	Capacity (users)	Fall height (ft & in)	Total height (ft & in)	Use zone dimensions (ft <sup>2</sup> )	Use zone dimensions (ft & in x ft & in)	Installation (hours)	Total CO <sub>2</sub> e (kg CO <sub>2</sub> e)
PCE112531	Elements Cliff Rider	5 - 12	12	8'6"	15'10"	382	16'4" x 28'1"	22	1,561
PCE211731	Cliff Rider Extreme	5 - 12	26	7'10"	18'9"	983	39'5" x 38'1"	52	3,514
PCE310531	Cliff Rider Ultimate	5 - 12	40	8'6"	17'11"	1245	50'4" x 40'0"	59	4,441
PCE610331	McKinley	5 - 12	90	9'1"	21'2"	2691	75'4" x 64'5"	117	11,316
PCE610431	Everest	5 - 12	105	11'0"	19'1"	2607	64'2" x 62'6"	124	10,383



# FLEXIBILITY

With a variety of colors and part options, we offer lots of flexibility and customization with our standard products.



TODDLER  
Age 1-4



TODDLER & GROW colors



Sky

Blossom

Nature

GROW  
Age 2-6



GO  
Age 4-12



GO colors



Sky

Modern

Nature



# OPTIONS



PRODUCT CONFIGURATOR  
www.kompan.com

PE slides



Stainless steel

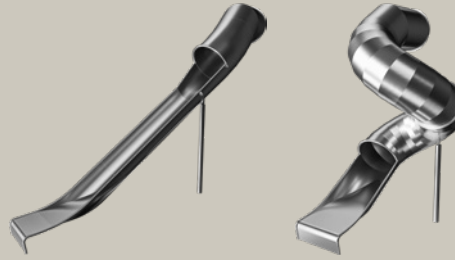

Anti-climb panels



NOTE:  
Steel slides heated by the midday sun can cause severe skin burns. We recommend pointing steel slides away from the midday sun or using PE slides or shading.

TODDLER play features



GROW play features

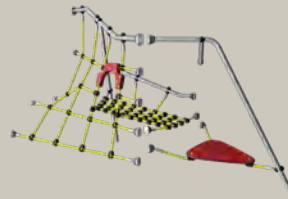
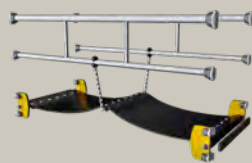

GO play feature

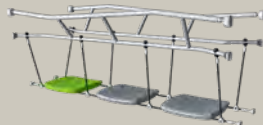

Posts



Anthracite steel

Dark blue steel

Brown steel

Integrated shading option



## More flexibility

Contact us for more information on the wide range of options for configurable playground equipment. Please note that prices and delivery terms depend on specified configurations.



# ELEMENTS™ ESSENTIALS

## Physical Play in Premium Quality

The Elements™ Essentials range holds fun and physically developing play activities for adventurous pre-schoolers and other school-age children. Loaded with essential age-appropriate play value that draws on classic playground activities, you can match the developmental needs of your users.

This range is premium quality and premium play for all ages.

See options on the FLEXIBILITY page.



### For a greener future

#### Post-consumer recycled materials:

EcoCore™ Panels	>95%
Hollow Plastic Parts	33%
Hercules Rope Yarn	>95%
Molded Decks	75%

Extruded aluminium made with low-carbon aluminium  
Steel parts adhere to industrial standards



AGE 2-5  
YEARS

Trouper with Roof  
PCE105932



Coach with Roof  
PCE105532



Sprinter with Roof  
PCE105632



Journeyer with Roof  
PCE205732



Trekker with Roof  
PCE205832

## PRODUCT INFORMATION

Product number	Product name	Age (years)	Capacity (users)	Fall height (ft & in)	Total height (ft & in)	Use zone dimensions (ft <sup>2</sup> )	Use zone dimensions (ft & in x ft & in)	Installation (hours)	Total CO <sub>2</sub> e (kg CO <sub>2</sub> e)
PCE105932	Trouper with Roof	2 - 5	20	3'10"	11'9"	590	27'8" x 31'6"	25	1,485
PCE105532	Coach with Roof	2 - 5	9	3'3"	12'7"	412	22'3" x 24'4"	15	850
PCE105632	Sprinter with Roof	2 - 5	16	3'10"	13'4"	609	29'3" x 33'6"	22	1,294
PCE205732	Journeyer with Roof	2 - 5	20	3'10"	13'4"	616	30'7" x 30'5"	26	1,494
PCE205832	Trekker with Roof	2 - 5	19	3'10"	13'4"	723	35'1" x 33'9"	26	1,661



# ELEMENTS™ ESSENTIALS

AGE 2-12  
YEARS



Denali with Roof  
PCE410132



Yosemite with Roof  
PCE111732



Yellowstone with Roof  
PCE211132



Acadia with Roof  
PCE111632



Grand Canyon with Roof  
PCE211232



Mansulu with Roof  
PCE211832

## PRODUCT INFORMATION

Product number	Product name	Age (years)	Capacity (users)	Fall height (ft & in)	Total height (ft & in)	Use zone dimensions (ft <sup>2</sup> )	Use zone dimensions (ft & in x ft & in)	Installation (hours)	Total CO <sub>2</sub> e (kg CO <sub>2</sub> e)
PCE410132	Denali with Roof	2 - 12	36	7'3"	14'8"	1186	43'12" x 37'11"	55	3,460
PCE111732	Yosemite with Roof	2 - 12	17	7'4"	14'2"	670	33'0" x 30'1"	23	1,456
PCE211132	Yellowstone with Roof	2 - 12	19	7'3"	16'2"	744	35'7" x 29'10"	30	1,923
PCE111632	Acadia with Roof	2 - 12	11	3'10"	14'2"	537	24'8" x 29'2"	21	1,235
PCE211232	Grand Canyon with Roof	2 - 12	22	3'10"	14'2"	894	40'8" x 31'2"	36	2,127
PCE211832	Mansulu with Roof	2 - 12	26	3'10"	14'2"	953	40'0" x 33'3"	39	2,412



# ELEMENTS™ ESSENTIALS



Cantata with Roof  
PCE212032



Mount Meru with Roof  
PCE111432



Trivor with Roof  
PCE111532



Pikes Peak with Roof  
PCE210932



Mauna Kea with Roof  
PCE211032



Lhotse with Roof  
PCE211932

## PRODUCT INFORMATION

Product number	Product name	Age (years)	Capacity (users)	Fall height (ft & in)	Total height (ft & in)	Use zone dimensions (ft <sup>2</sup> )	Use zone dimensions (ft & in x ft & in)	Installation (hours)	Total CO <sub>2</sub> e (kg CO <sub>2</sub> e)
PCE212032	Cantata with Roof	5 - 12	22	7'3"	14'8"	806	35'3" x 32'9"	27	1,932
PCE111432	Mount Meru with Roof	5 - 12	13	4'10"	15'2"	575	31'0" x 28'7"	21	1,274
PCE111532	Trivor with Roof	5 - 12	15	7'1"	15'2"	659	31'0" x 32'1"	24	1,530
PCE210932	Pikes Peak with Roof	5 - 12	17	4'10"	15'2"	698	35'2" x 32'3"	26	1,683
PCE211032	Mauna Kea with Roof	5 - 12	22	7'3"	15'2"	908	37'5" x 40'2"	29	2,040
PCE211932	Lhotse with Roof	5 - 12	27	4'10"	15'2"	819	40'9" x 29'0"	37	2,390



# FLEXIBILITY

With a variety of colors and part options, we offer lots of flexibility and customization with our standard products.



Sky



Blossom



Nature

# OPTIONS



PRODUCT CONFIGURATOR  
www.kompan.com

Slides in PE or stainless steel

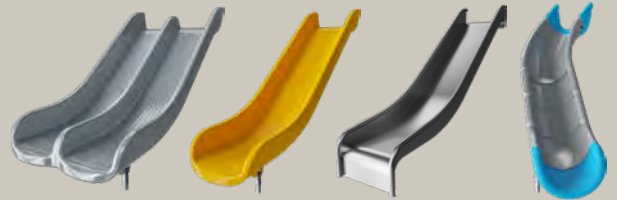

NOTE:  
Steel slides heated by the midday sun can cause severe skin burns. We recommend pointing steel slides away from the midday sun or using PE slides or shading.

Play panels

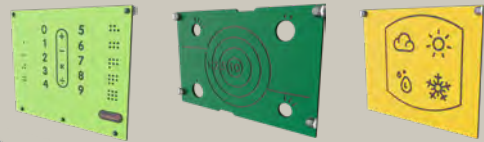

PE roof



Integrated shading option



Posts



Anthracite steel



Dark blue steel



Brown steel

## More flexibility

Contact us for more information on the wide range of options for configurable playground equipment. Please note that prices and delivery terms depend on specified configurations.



# GALAXY™

## A Modern Playground for Tweens and Teens

Teens and tweens like to play and hang out in playgrounds. Therefore, we developed a series of equipment for older children as a crossover between playgrounds and fitness sites.

Galaxy™ was the world's first solution to move away from the traditional post-and-platform and play-tower designs. It also became the first free-play design to include all children regardless of abilities.

See options on the FLEXIBILITY page.



Pavo  
GXY901



### For a greener future

#### Post-consumer recycled materials:

EcoCore™ Panels	>95%
Hollow Plastic Parts	33%
Hercules Rope Yarn	>95%

Steel parts adhere to industrial standards



Enif  
GXY902



Kuma  
GXY903



Regulus  
GXY939



Aldebaran  
GXY941

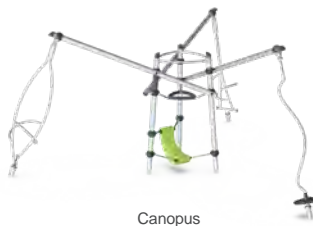

Canopus  
GXY961

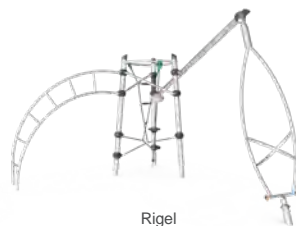

Rigel  
GXY962

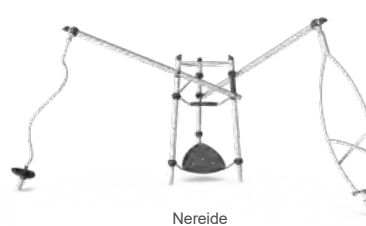

Nereide  
GXY963

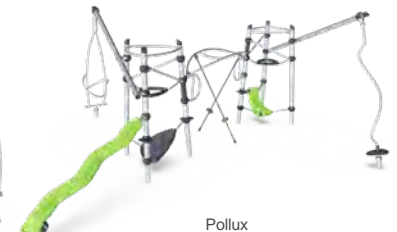

Pollux  
GXY964

## PRODUCT INFORMATION

Product number	Product name	Age (years)	Capacity (users)	Fall height (ft & in)	Total height (ft & in)	Use zone dimensions (ft²)	Use zone dimensions (ft & in x ft & in)	Installation (hours)	Total CO <sub>2</sub> e (kg CO <sub>2</sub> e)
GXY901	Pavo	5 - 12	12	8'3"	8'8"	485	25'4" x 27'11"	13	1,009
GXY902	Enif	5 - 12	15	8'5"	8'8"	545	35'5" x 21'11"	20	1,564
GXY903	Kuma	5 - 12	17	8'3"	8'8"	588	35'8" x 21'2"	20	1,747
GXY939	Regulus	5 - 12	14	8'2"	8'8"	626	27'9" x 30'1"	17	1,509
GXY941	Aldebaran	5 - 12	21	8'5"	8'8"	743	42'7" x 25'12"	24	2,094
GXY961	Canopus	5 - 12	9	8'2"	10'3"	620	33'11" x 32'7"	11	1,349
GXY962	Rigel	5 - 12	8	8'2"	10'3"	448	24'1" x 27'1"	9.9	873
GXY963	Nereide	5 - 12	6	8'2"	10'3"	488	25'2" x 32'7"	10	1,152
GXY964	Pollux	5 - 12	16	8'3"	10'3"	803	36'7" x 32'5"	20	2,167





Draco  
GXY943

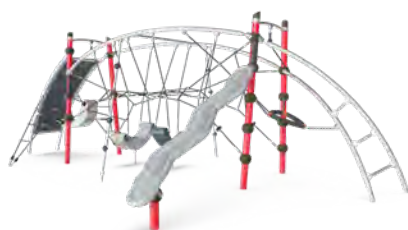

Aquila II  
GXY949



Adara II  
GXY950



Sirius II  
GXY965

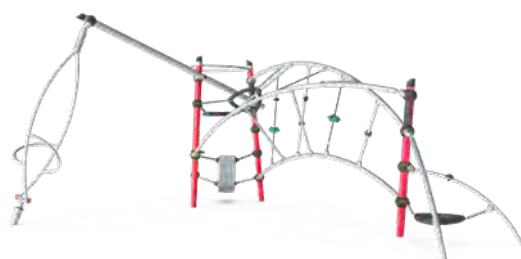

Asterion II  
GXY966



Asterope  
GXY967

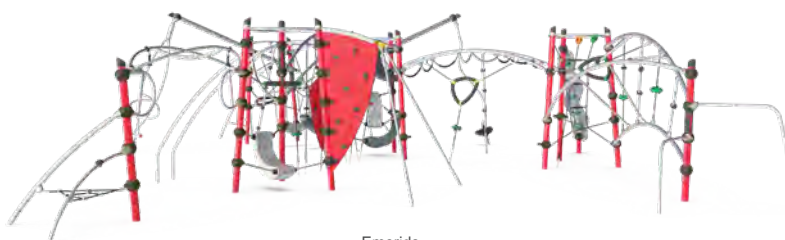

Emerido  
GXY968



## PRODUCT INFORMATION

Product number	Product name	Age (years)	Capacity (users)	Fall height (ft & in)	Total height (ft & in)	Use zone dimensions (ft²)	Use zone dimensions (ft & in x ft & in)	Installation (hours)	Total CO <sub>2</sub> e (kg CO <sub>2</sub> e)
GXY943	Draco	5 - 12	28	8'5"	8'8"	995	45'8" x 39'4"	33	3,117
GXY949	Aquila II	5 - 12	22	8'3"	8'3"	732	37'8" x 27'9"	24	2,138
GXY950	Adara II	5 - 12	21	8'2"	8'8"	727	42'4" x 22'6"	23	2,171
GXY965	Sirius II	5 - 12	10	8'3"	10'3"	498	24'3" x 30'9"	14	1,174
GXY966	Asterion II	5 - 12	14	8'2"	10'3"	616	34'1" x 27'1"	18	1,704
GXY967	Asterope	5 - 12	28	8'3"	10'3"	1005	41'9" x 37'8"	29	2,978
GXY968	Emerido	5 - 12	55	8'5"	10'3"	1892	63'3" x 53'0"	61	6,034



# FLEXIBILITY

With a variety of colors and part options, we offer lots of flexibility and customization with our standard products.

## COLOR THEMES IN HOT-DIP GALVANIZED AND PAINTED STEEL



Mars Red



Terra Lime Green



Neptune Light Blue



Solaris Yellow



Venus Orange

## COLOR THEMES IN HOT-DIP GALVANIZED STEEL



Luna Black



Night Sky Blue



Lime Green



# OPTIONS

Stables

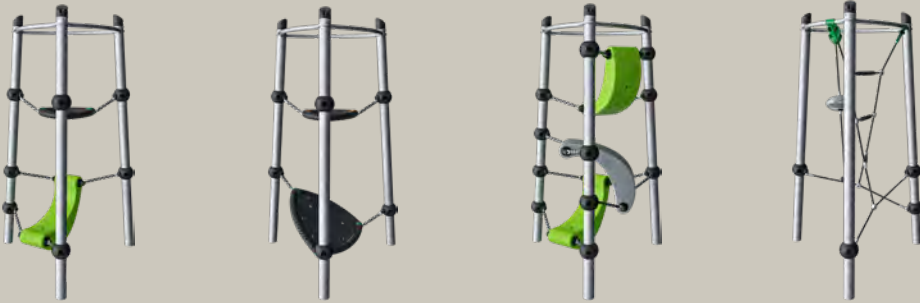

Links



Activities

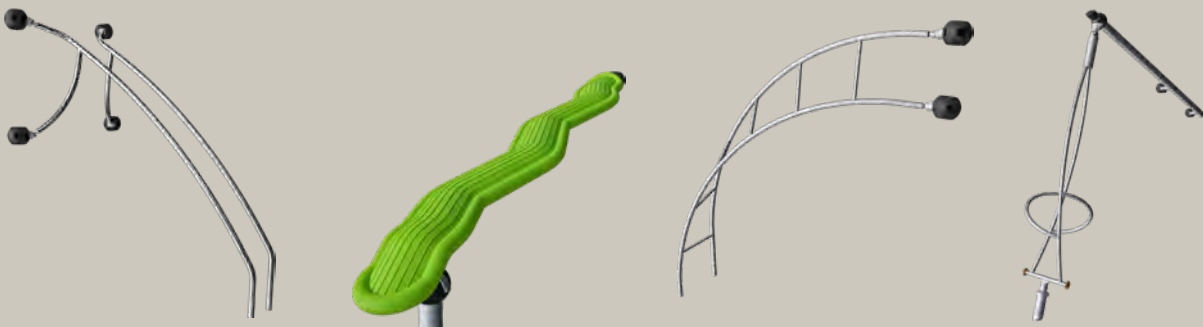

Anchors



## More flexibility

Contact us for more information on the wide range of options for configurable playground equipment. Please note that prices and delivery terms depend on specified configurations.



# BLOQX™

## A Fun, Simple, Scalable System

Bloqx™ offers a unique and intense climbing experience. Sometimes exhausting – even for tweens and teens! That's why the design accommodates rewarding hang-out spots on the upper surface of the pentagon shapes.

The Bloqx™ design is a favored selfie platform, which tells us that Bloqx™ has made its mark with the target group: Tweens and teenagers. That's pretty cool.



BLOQX 3  
BLX4103

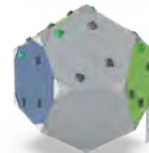

BLOQX 1  
BLX4101

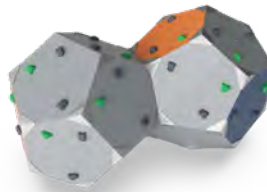

BLOQX 2  
BLX4102

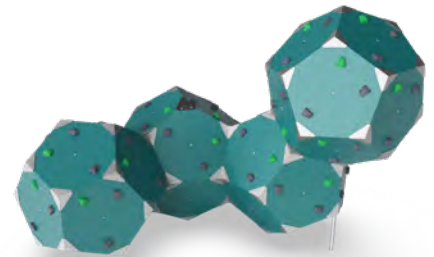

BLOQX 4  
BLX4104

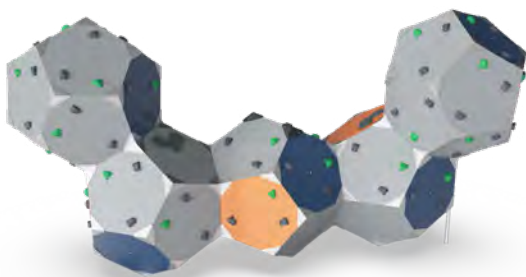

BLOQX 5  
BLX4105

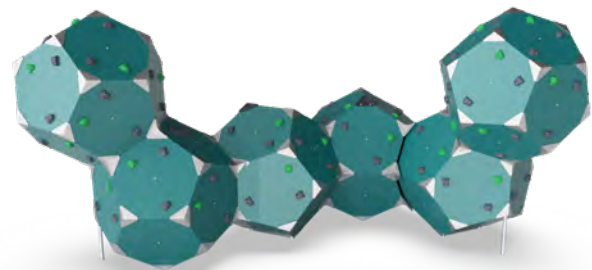

BLOQX 6  
BLX4106



**For a greener future**  
Post-consumer recycled materials:  
Molded Decks 75%

### PRODUCT INFORMATION

Product number	Product name	Age (years)	Capacity (users)	Fall height (ft & in)	Total height (ft & in)	Use zone dimensions (ft²)	Use zone dimensions (ft & in x ft & in)	Installation (hours)	Total CO <sub>2</sub> e (kg CO <sub>2</sub> e)
BLX4103	BLOQX 3	5 - 15	16	9'10"	9'10"	371	24'3" x 19'1"	21	643
BLX4101	BLOQX 1	5 - 15	8	6'9"	6'9"	269	17'9" x 19'1"	9.1	292
BLX4102	BLOQX 2	5 - 15	10	5'7"	5'7"	324	21'6" x 18'1"	14	445
BLX4104	BLOQX 4	5 - 15	22	9'10"	9'10"	450	27'0" x 22'2"	28	854
BLX4105	BLOQX 5	5 - 15	28	9'10"	9'10"	501	31'9" x 20'0"	34	1,054
BLX4106	BLOQX 6	5 - 15	32	9'10"	9'10"	579	31'7" x 25'5"	41	1,265



# FLEXIBILITY

With a variety of colors and part options, we offer lots of flexibility and customization with our standard products.

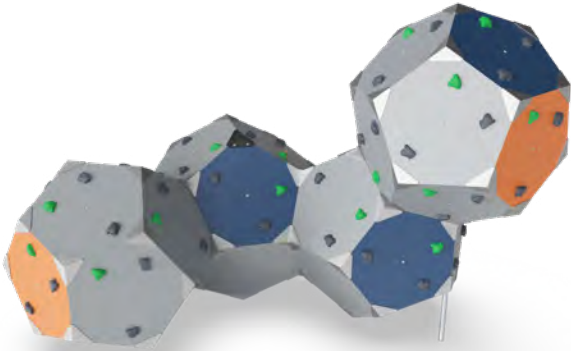

Orange

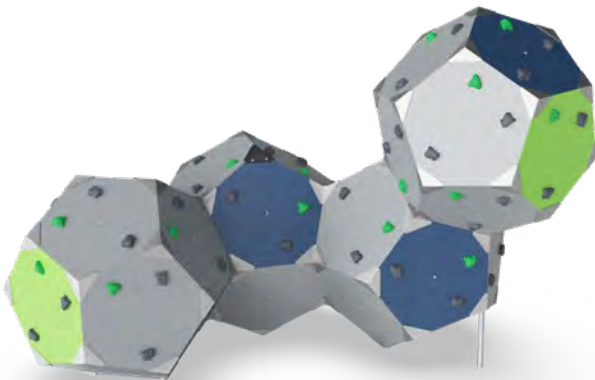

Lime

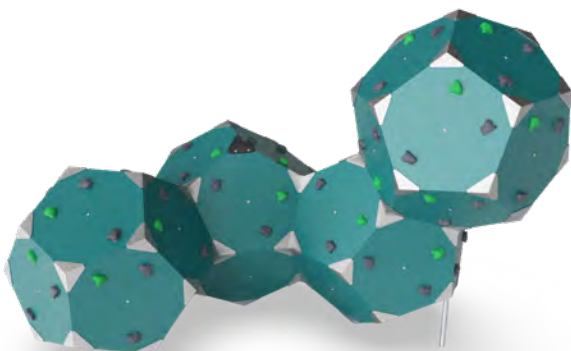

Teal

# OPTIONS

## Moulded PP panels

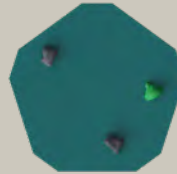

Teal

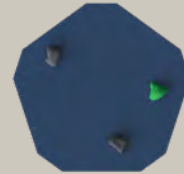

Dark blue



Medium grey



Lime



Orange

## EcoCore™ panel colors



## Corner brackets



Standard aluminium



Powder-coated in a bright color

## NOTE:

Powder-coated corner brackets are designed to absorb and release less heat. KOMPAN therefore recommends using powder-coated corner brackets for high-temperature areas and areas in direct sunlight.

## More flexibility

Contact us for more information on the wide range of options for configurable playground equipment. Please note that prices and delivery terms depend on specified configurations.









# FREESTANDING PLAY EQUIPMENT



# SUPERNOVA, CAROUSELS & SPINNERS

## Spinning with Joy

Children need the dizzying input that comes from spinning. These important movement experiences help the child's nervous system mature and organize. Besides being great fun, the spinners and carousels also help children train their sense of balance.

Our innovative spinners and carousels attract children of all ages and abilities and the best part is: They LOVE it!



### For a greener future

#### Post-consumer recycled materials:

EcoCore™ Panels >95%  
Hollow Plastic Parts 33%

Steel parts adhere to industrial standards



Tipi Carousel w/ Top Brace  
ELE400065



Spinner Bowl  
ELE400024



Tipi Carousel  
ELE400064



Spinner Plate  
ELE500008



Junior Spica  
ELE400158



Scooter Carousel  
PCM160



## PRODUCT INFORMATION

Product number	Product name	Age (years)	Capacity (users)	Fall height (ft & in)	Total height (ft & in)	Use zone dimensions (ft <sup>2</sup> )	Use zone dimensions (ft & in x ft & in)	Installation (hours)	Total CO <sub>2</sub> e (kg CO <sub>2</sub> e)
ELE400065	Tipi Carousel w/ Top Brace	5 - 12	8	3'3"	4'0"	380	21'12" x 21'12"	2.5	232
ELE400024	Spinner Bowl	5 - 12	1	1'12"	1'12"	149	13'9" x 13'9"	1.2	55
ELE400064	Tipi Carousel	5 - 12	6	1'9"	1'9"	380	21'12" x 21'12"	2.5	209
ELE500008	Spinner Plate	2 - 12	1	1'2"	1'2"	139	13'4" x 13'4"	1.4	43
ELE400158	Junior Spica	2 - 5	1	0'7"	3'5"	139	13'4" x 13'4"	1.6	65
PCM160	Scooter Carousel	5 - 12	3	1'8"	3'1"	168	14'8" x 14'8"	2.5	209



**NEW** 

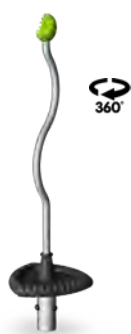

Rocket Roller™  
GXY970  

Spica 1  
GXY8014

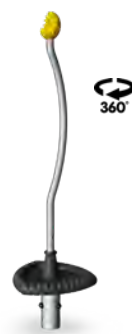

Spica 2  
GXY8015



Spica 3  
GXY8016

## PRODUCT INFORMATION

Product number	Product name	Age (years)	Capacity (users)	Fall height (ft & in)	Total height (ft & in)	Use zone dimensions (ft²)	Use zone dimensions (ft & in x ft & in)	Installation (hours)	Total CO <sub>2</sub> e (kg CO <sub>2</sub> e)
GXY970	Rocket Roller™	5 - 12	2	3'3"	8'2"	400	22'7" x 22'7"	3.1	317
GXY8014	Spica 1	5 - 12	1	3'3"	5'7"	146	13'8" x 13'8"	1.6	111
GXY8015	Spica 2	5 - 12	1	3'3"	5'7"	146	13'8" x 13'8"	1.6	110
GXY8016	Spica 3	5 - 12	1	3'3"	5'7"	146	13'8" x 13'8"	1.6	111



# SUPERNOVA, CAROUSELS & SPINNERS



PATENTED

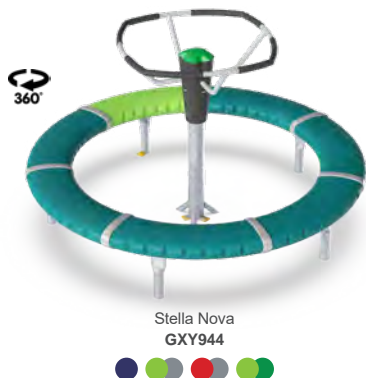

PCM157 NOTE: For high-temperature areas and in direct sunlight where the aluminum risks becoming too hot, we recommend ordering the HPL Deck.

## PRODUCT INFORMATION

Product number	Product name	Age (years)	Capacity (users)	Fall height (ft & in)	Total height (ft & in)	Use zone dimensions (ft <sup>2</sup> )	Use zone dimensions (ft & in x ft & in)	Installation (hours)	Total CO <sub>2</sub> e (kg CO <sub>2</sub> e)
PCM157	Universal Carousel	2 - 12	8	1'3"	2'4"	484	24'10" x 24'10"	6.3	628
ELE400063	Multispinner Carousel, Teal	5 - 12	7	2'6"	2'6"	445	23'9" x 23'9"	5.3	316
GXY959	Spinner Disc	5 - 12	7	3'3"	2'5"	448	23'11" x 23'11"	3.8	297
GXY960	Supernova	5 - 12	8	2'4"	2'4"	484	24'10" x 24'10"	3	428
GXY944	Stella Nova	5 - 12	8	1'3"	3'9"	484	24'10" x 24'10"	5	527





Toddler Carousel  
PCM154



Twin Ring Sky Carousel  
PCM151



Turbo Carousel  
PCM161



Saturn Carousel  
GXY957



Saturn 4 Carousel  
GXY958



## PRODUCT INFORMATION

Product number	Product name	Age (years)	Capacity (users)	Fall height (ft & in)	Total height (ft & in)	Use zone dimensions (ft <sup>2</sup> )	Use zone dimensions (ft & in x ft & in)	Installation (hours)	Total CO <sub>2</sub> e (kg CO <sub>2</sub> e)
PCM154	Toddler Carousel	2 - 5	3	4'11"	7'9"	795	31'10" x 31'10"	3.8	461
PCM151	Twin Ring Sky Carousel	5 - 12	6	5'8"	5'12"	375	21'10" x 21'10"	2.7	293
PCM161	Turbo Carousel	5 - 12	9	6'7"	7'7"	282	18'11" x 18'11"	3.9	432
GXY957	Saturn Carousel	5 - 12	2	7'1"	8'4"	1112	50'9" x 50'9"	3.1	428
GXY958	Saturn 4 Carousel	5 - 12	4	7'1"	8'4"	2020	50'9" x 50'9"	4.2	585



# TWISTING NETS

## Rotating Together

No child can resist the magnetic attraction of these dynamic Twisters. The freestanding Twisting Rope Nets combine two favorite play activities in one play structure: The challenge of climbing and a thrilling rotation.

Twisters are not only a fun and collaborative play activity but also cool hang-out spots. Hang on and enjoy the ride!



### For a greener future

Post-consumer recycled materials:

Hercules Rope Yarn

>95%

Steel parts adhere to industrial standards



Inclusive Twister  
COR20330



Mini Twister  
COR20310



Cone Twister  
COR20320



Net Twister  
COR20301



Rhombus Twister  
COR20340



## PRODUCT INFORMATION

Product number	Product name	Age (years)	Capacity (users)	Fall height (ft & in)	Total height (ft & in)	Use zone dimensions (ft <sup>2</sup> )	Use zone dimensions (ft & in x ft & in)	Installation (hours)	Total CO <sub>2</sub> e (kg CO <sub>2</sub> e)
COR20330	Inclusive Twister	5 - 12	12	7'4"	7'5"	437	23'7" x 23'7"	5.6	681
COR20310	Mini Twister	5 - 12	7	4'1"	7'5"	383	22'1" x 22'1"	5.3	540
COR20320	Cone Twister	5 - 12	9	4'11"	7'0"	437	23'7" x 23'7"	4.1	544
COR20301	Net Twister	5 - 12	10	9'2"	9'2"	573	27'0" x 27'0"	4.5	678
COR20340	Rhombus Twister	5 - 12	10	8'0"	9'6"	437	23'7" x 23'7"	5.6	699



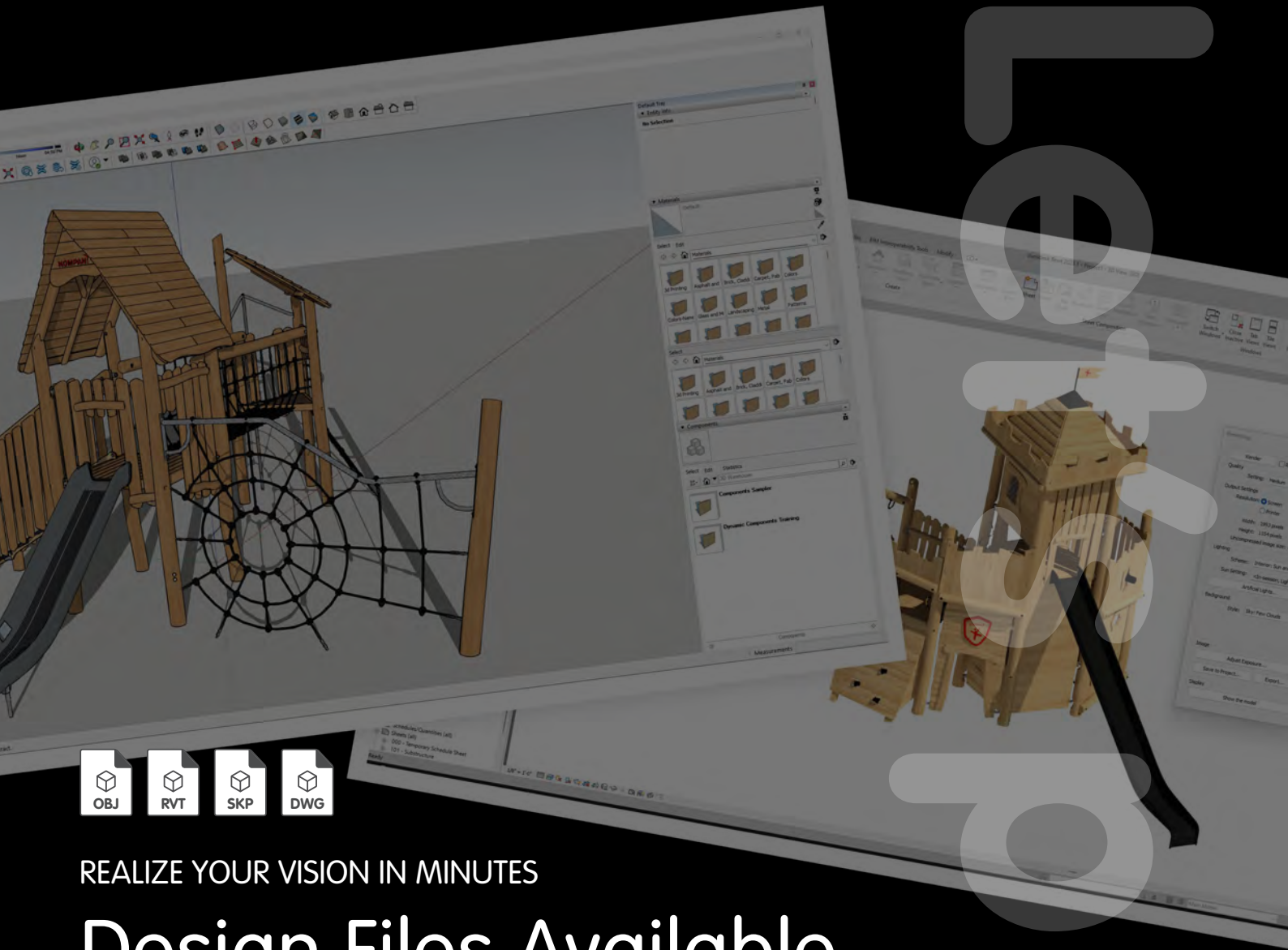

REALIZE YOUR VISION IN MINUTES

# Design Files Available for Download

OBJ, Revit, SketchUp, and DWG file formats for KOMPAN products are available for download.

Visit our website to retrieve a complete package containing product variants, colors, and material options for direct use in your design program. Downloading these formats lets you design your playground or fitness area in minutes.

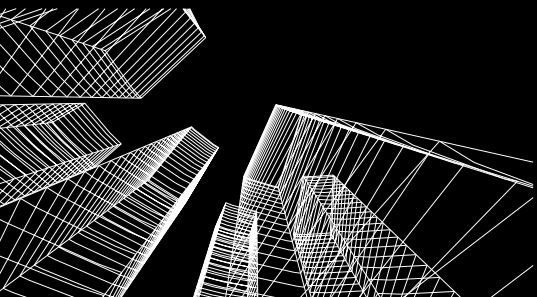



# BALANCING AND CLIMBING

## So Simple, Yet so Important

A somersault bar, stepping pod, or climbing net may not look like much, but through fun play, they contribute to childhood development. Rotating trains the child's sense of space, climbing trains the child's cross-coordination skills, and jumping trains the child's agility and balance.

All these motor skills are vital to navigating the world confidently, for instance, when judging distances in traffic.



### For a greener future

#### Post-consumer recycled materials:

EcoCore™ Panels  
Hercules Rope Yarn  
TexMade™ Posts

>95%  
>95%  
>95%

Steel parts adhere to industrial standards



Flexus  
GXY919



Rock-it  
GXY934



Argo  
GXY8019



Starsurfer  
GXY935



Stepping Pod, Ground Level  
M87401



Stepping Pod, 1 ft  
M87402



Stepping Pod, 2 ft  
M87403



Double Somersault Bars  
PCM802



Triple Somersault Bars  
PCM803

## PRODUCT INFORMATION

Product number	Product name	Age (years)	Capacity (users)	Fall height (ft & in)	Total height (ft & in)	Use zone dimensions (ft²)	Use zone dimensions (ft & in x ft & in)	Installation (hours)	Total CO <sub>2</sub> e (kg CO <sub>2</sub> e)
GXY919	Flexus	5 - 12	1	4'5"	6'7"	259	19'8" x 17'7"	3.9	257
GXY934	Rock-it	5 - 12	8	1'12"	3'11"	241	17'12" x 17'2"	2.1	215
GXY8019	Argo	5 - 12	5	1'8"	1'8"	276	22'7" x 13'8"	3.3	231
GXY935	Starsurfer	5 - 12	2	2'4"	1'10"	264	17'12" x 19'5"	3.2	201
M87401	Stepping Pod, Ground Level	2 - 12	1	0'4"	0'4"	131	12'11" x 12'11"	0.4	38
M87402	Stepping Pod, 1 ft	2 - 12	1	0'12"	0'12"	131	12'11" x 12'11"	0.5	42
M87403	Stepping Pod, 2 ft	5 - 12	1	1'11"	1'11"	131	12'11" x 12'11"	0.5	47
PCM802	Double Somersault Bars	2 - 12	2	4'10"	5'7"	207	18'12" x 14'1"	2.7	140
PCM803	Triple Somersault Bars	2 - 12	3	4'10"	5'7"	250	22'1" x 15'11"	3.2	188





Uno Climber  
PCM81021



Duo Climber  
PCM81121



Trio Climber  
PCM81221



Penta Climber  
PCM81331



Sway Alley  
PCM80921



Balance Beam, Round  
PCM80621



Somersault Ring  
PCM80821

## PRODUCT INFORMATION

Emission: Standard version / Greenest version

Product number	Product name	Age (years)	Capacity (users)	Fall height (ft & in)	Total height (ft & in)	Use zone dimensions (ft <sup>2</sup> )	Use zone dimensions (ft & in x ft & in)	Installation (hours)	Total CO <sub>2</sub> e (kg CO <sub>2</sub> e)
PCM81021	Uno Climber	5 - 12	5	7'4"	7'10"	304	15'11" x 21'5"	5	358 / 285
PCM81121	Duo Climber	5 - 12	12	7'4"	7'7"	379	19'5" x 23'5"	7.5	619 / 489
PCM81221	Trio Climber	5 - 12	19	7'4"	7'7"	449	22'12" x 23'5"	9.9	823 / 644
PCM81331	Penta Climber	5 - 12	8	7'9"	11'1"	328	21'5" x 21'9"	9.4	663 / 524
PCM80921	Sway Alley	5 - 12	2	1'3"	4'1"	274	15'11" x 19'5"	7.5	309 / 247
PCM80621	Balance Beam, Round	5 - 12	2	1'4"	1'6"	208	19'5" x 12'4"	2.5	78 / -
PCM80721	Balance Beam, Flat	5 - 12	2	1'4"	1'6"	209	19'5" x 12'6"	2.9	94 / -
PCM80821	Somersault Ring	5 - 12	6	6'6"	6'11"	283	19'5" x 18'6"	4.1	327 / -



# SPRINGERS

## KOMPAN Invented a New Way of Rocking, and We've Been Rocking the World Since 1970

This is where it all began: A red hen on a bright blue spring. The Crazy Hen was the world's first play design to deliver a fun and more functional alternative to the traditional seesaw. Today, the iconic shape is recognizable worldwide.

Every playground springer is just waiting for a child to unlock their creative potential. And you don't need a second user – or a counter-weight – to get rocking!



**For a greener future**  
**Post-consumer recycled materials:**

EcoCore™ Panels	>95%
Hollow Plastic Parts	33%

Steel parts adhere to industrial standards



Hen

M101



Gander  
M106



Dragon  
M113



Scrambler  
M130



Ambulance  
M166



Horse  
M172



Elephant  
M123



### PRODUCT INFORMATION

Product number	Product name	Age (years)	Capacity (users)	Fall height (ft & in)	Total height (ft & in)	Use zone dimensions (ft²)	Use zone dimensions (ft & in x ft & in)	Installation (hours)	Total CO <sub>2</sub> e (kg CO <sub>2</sub> e)
M101	Hen	2 - 12	1	1'7"	2'6"	168	13'2" x 15'1"	2.3	63
M106	Gander	2 - 5	1	1'6"	2'7"	175	13'11" x 14'9"	3.2	97
M113	Dragon	2 - 5	1	1'5"	2'11"	163	13'3" x 14'6"	1	74
M130	Scrambler	2 - 5	2	1'9"	2'9"	166	13'2" x 14'12"	2.9	74
M166	Ambulance	2 - 5	1	1'4"	2'7"	161	13'4" x 14'6"	1.5	80
M172	Horse	2 - 5	1	1'7"	2'8"	156	13'2" x 15'2"	2.3	63
M123	Elephant	2 - 5	1	1'5"	2'4"	158	13'4" x 14'2"	2.4	74





Gorilla  
M165



Lady Bug  
M168



Dune Buggy  
M170



Front Loader  
M171



Scooter  
KPL101



Sea Lion  
KPL102



Kangaroo  
KPL103



Dolphin  
PCM103



Dolphin, Double  
PCM104



Horse  
PCM105



Horse, Double  
PCM106



Double Springer, Two Seats  
KPL121



## PRODUCT INFORMATION

Product number	Product name	Age (years)	Capacity (users)	Fall height (ft & in)	Total height (ft & in)	Use zone dimensions (ft <sup>2</sup> )	Use zone dimensions (ft & in x ft & in)	Installation (hours)	Total CO <sub>2</sub> e (kg CO <sub>2</sub> e)
M165	Gorilla	2 - 5	1	1'4"	2'8"	156	13'4" x 14'2"	1.4	78
M168	Lady Bug	2 - 5	1	1'4"	2'7"	157	13'4" x 14'3"	1.4	81
M170	Dune Buggy	2 - 5	1	1'4"	2'6"	167	13'4" x 14'11"	1.4	81
M171	Front Loader	2 - 5	1	1'4"	2'9"	163	13'4" x 14'7"	1.4	82
KPL101	Scooter	2 - 12	1	1'7"	2'4"	168	13'2" x 15'1"	2.3	62
KPL102	Sea Lion	2 - 12	1	1'7"	2'10"	168	13'2" x 15'1"	2.3	62
KPL103	Kangaroo	2 - 12	1	1'7"	2'8"	168	13'2" x 15'1"	2.3	62
PCM103	Dolphin	2 - 5	1	1'4"	2'5"	170	13'2" x 15'3"	2.1	70
PCM104	Dolphin, Double	2 - 5	2	1'4"	2'5"	191	14'6" x 15'3"	2.8	121
PCM105	Horse	2 - 5	1	1'4"	2'5"	170	13'2" x 15'3"	2.1	70
PCM106	Horse, Double	2 - 5	2	1'4"	2'4"	191	14'6" x 15'3"	2.8	121
KPL121	Double Springer, Two Seats	2 - 5	2	1'3"	2'2"	172	15'1" x 13'2"	2.4	98



# SPRINGERS



Water Lilies  
M175



Springer Bowl with Footrest  
ELE400067



Racer  
ELE400002



Stinger  
ELE400020



Fairy Tale Dog  
M173



Swan  
M174



Fairy Tale Cat  
M177

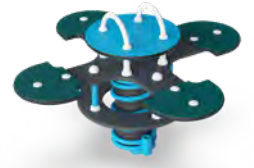

Daisy  
M128



## PRODUCT INFORMATION

Product number	Product name	Age (years)	Capacity (users)	Fall height (ft & in)	Total height (ft & in)	Use zone dimensions (ft <sup>2</sup> )	Use zone dimensions (ft & in x ft & in)	Installation (hours)	Total CO <sub>2</sub> e (kg CO <sub>2</sub> e)
M175	Water Lilies	2 - 5	4	1'8"	2'0"	192	15'5" x 15'5"	3	135
ELE400067	Springer Bowl with Footrest	5 - 12	1	1'12"	1'12"	158	13'10" x 14'4"	1.5	87
ELE400002	Racer	2 - 5	1	1'5"	2'3"	153	14'4" x 13'3"	1.4	81
ELE400020	Stinger	2 - 5	1	1'5"	2'4"	154	14'6" x 13'2"	1.6	76
M173	Fairy Tale Dog	2 - 5	1	1'6"	2'7"	156	13'2" x 15'1"	2.6	71
M174	Swan	2 - 5	1	1'7"	2'7"	168	13'11" x 14'6"	3.2	103
M177	Fairy Tale Cat	2 - 5	1	1'3"	2'7"	151	13'4" x 13'8"	2.3	73
M128	Daisy	2 - 5	4	1'12"	2'0"	184	15'3" x 15'3"	1.1	128



# USE OUR TOOLS AND SITE-PLANNING RESOURCES

to make your playground and outdoor fitness planning simple.

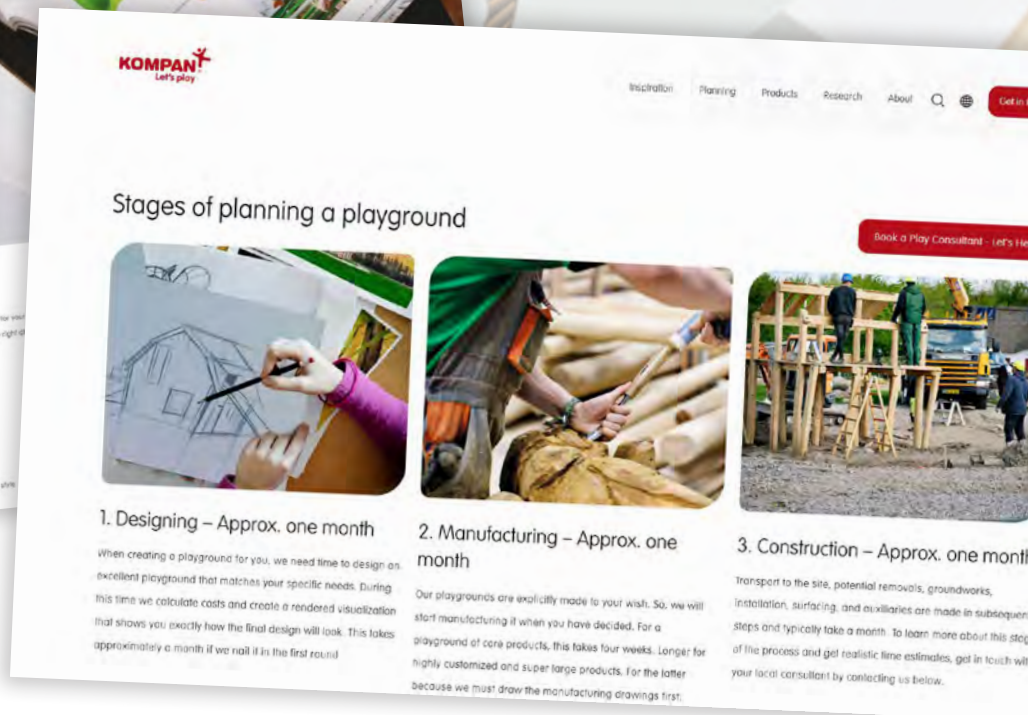
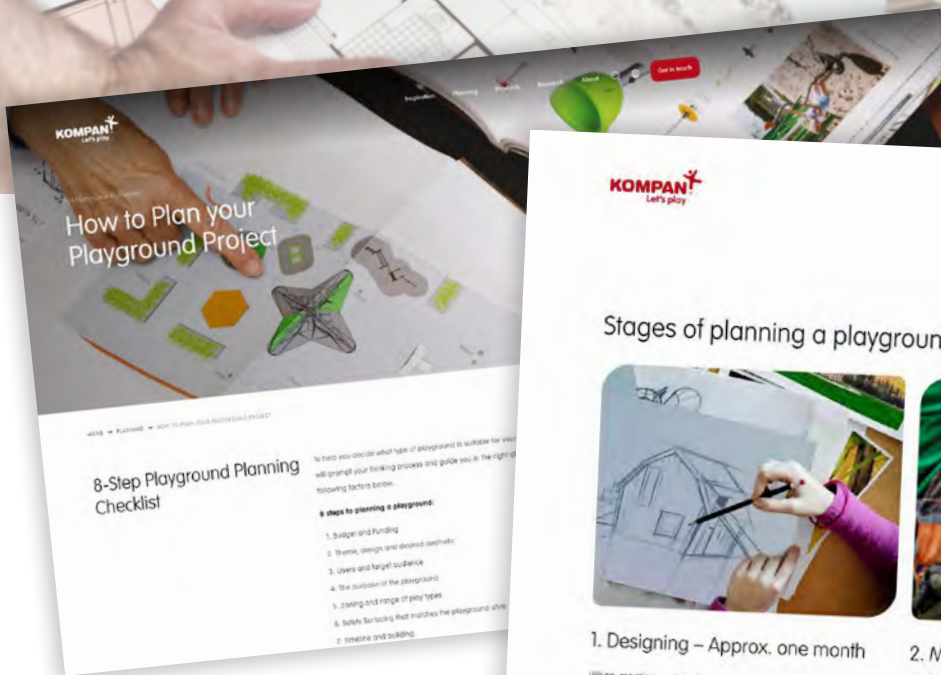

**Our site-planning resources and tools will help you with every step, such as:**

- Fundraising
- Installation
- Choosing the suitable playground or fitness equipment for your community, municipality, or school





# SEESAWS

## The Fun Thrill of Rocking

Seesaws add a social dimension to the joy of rocking. Rocking on a seesaw trains children’s muscles, motor skills, balance, and coordination. The spacious design and sturdy back and foot supports allow children of all abilities to play together.

The fun thrill of rocking will make children return for more. There is nothing better than rocking with a friend – or two!



### For a greener future

Post-consumer recycled materials:

EcoCore™ Panels  
Hollow Plastic Parts

>95%  
33%

Steel parts adhere to industrial standards

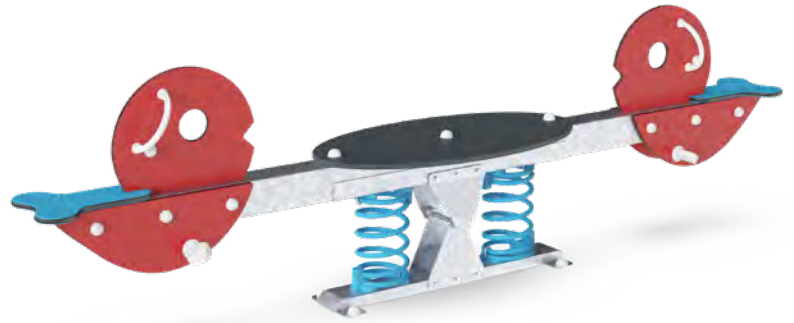

Albatross  
M143

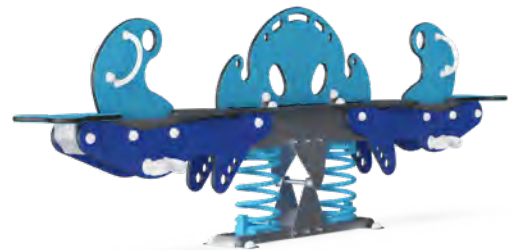

Octopus Seesaw  
M181



Horse Seesaw  
M182



Motorcycle Seesaw  
M183



## PRODUCT INFORMATION

Product number	Product name	Age (years)	Capacity (users)	Fall height (ft & in)	Total height (ft & in)	Use zone dimensions (ft²)	Use zone dimensions (ft & in x ft & in)	Installation (hours)	Total CO <sub>2</sub> e (kg CO <sub>2</sub> e)
M143	Albatross	2 - 12	4	3'3"	3'0"	276	15'10" x 22'3"	4.4	267
M181	Octopus Seesaw	2 - 12	4	3'3"	3'3"	272	14'10" x 22'2"	4.9	279
M182	Horse Seesaw	2 - 12	2	3'3"	3'1"	254	13'2" x 22'2"	4.3	254
M183	Motorcycle Seesaw	2 - 12	4	3'3"	2'8"	321	15'9" x 24'2"	4.7	287





Hopper  
ELE400022



Blazer  
ELE400021

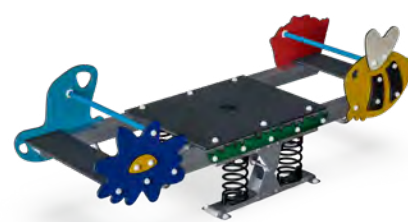

Garden Seesaw  
M186



Ocean Seesaw  
M187

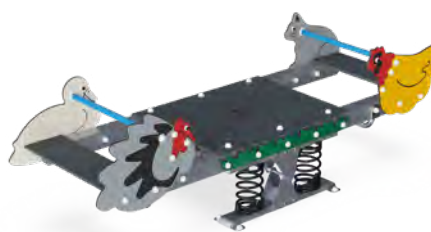

Fairy Tale Seesaw  
M176



Multi-Seesaw Support Seat  
M147



## PRODUCT INFORMATION

Product number	Product name	Age (years)	Capacity (users)	Fall height (ft & in)	Total height (ft & in)	Use zone dimensions (ft <sup>2</sup> )	Use zone dimensions (ft & in x ft & in)	Installation (hours)	Total CO <sub>2</sub> e (kg CO <sub>2</sub> e)
ELE400022	Hopper	2 - 5	4	3'3"	2'8"	278	22'8" x 15'0"	3.9	277
ELE400021	Blazer	2 - 5	6	3'3"	2'7"	277	19'7" x 18'8"	4	316
M186	Garden Seesaw	2 - 12	10	3'3"	3'7"	361	17'2" x 22'9"	8.7	599
M187	Ocean Seesaw	2 - 12	10	3'3"	3'3"	351	17'2" x 22'3"	8	593
M176	Fairy Tale Seesaw	2 - 5	10	3'3"	3'3"	351	17'2" x 22'3"	8.3	593
M147	Multi-Seesaw Support Seat	2 - 12	-	0'0"	1'9"	-	0'0" x 0'0"	2.1	49



# SAND & WATER PLAY

## A Vital Part of a Child's Creative and Cognitive Development

Playing with sand and water has a substantial developmental impact on a child. For example, building structures in the sand fosters a feeling of accomplishment in the child and sparks their creative thinking. Sand and water stations also encourage children to play together.

Our sand and water stations come in many shapes and sizes with an appealing look that awakens the curiosity in children.



### For a greener future

Post-consumer recycled materials:

EcoCore™ Panels

>95%

Steel parts adhere to industrial standards



Mermaid's Fountain  
PCM504



Fountain  
M593



Waterfall with Sand Table  
PCM505



Sand & Water Work Station  
MSC5419



Dolphin Work Station  
MSC5425

## PRODUCT INFORMATION

Product number	Product name	Age (years)	Capacity (users)	Fall height (ft & in)	Total height (ft & in)	Use zone dimensions (ft <sup>2</sup> )	Use zone dimensions (ft & in x ft & in)	Installation (hours)	Total CO <sub>2</sub> e (kg CO <sub>2</sub> e)
PCM504	Mermaid's Fountain	2 - 5	15	0'0"	7'1"	-	0'0" x 0'0"	6.7	241
M593	Fountain	2 - 5	1	0'0"	2'8"	-	0'0" x 0'0"	1.5	52
PCM505	Waterfall with Sand Table	2 - 5	17	0'0"	5'2"	-	0'0" x 0'0"	8.5	334
MSC5419	Sand & Water Work Station	2 - 5	5	0'0"	4'2"	-	0'0" x 0'0"	5.5	128
MSC5425	Dolphin Work Station	2 - 5	6	0'0"	4'6"	-	0'0" x 0'0"	5	128





Flower Table  
KPL503



Starfish  
M584



Rotating Sand Table  
PCM501  
● ●



Sand Desk with Seats  
PCM502  
● ●



Sandpit  
PCM503  
● ●



Sandbox  
BASIC550

## PRODUCT INFORMATION

Product number	Product name	Age (years)	Capacity (users)	Fall height (ft & in)	Total height (ft & in)	Use zone dimensions (ft <sup>2</sup> )	Use zone dimensions (ft & in x ft & in)	Installation (hours)	Total CO <sub>2</sub> e (kg CO <sub>2</sub> e)
KPL503	Flower Table	2 - 5	2	0'0"	1'10"	-	0'0" x 0'0"	1.4	21
M584	Starfish	2 - 5	2	0'0"	1'10"	-	0'0" x 0'0"	1.4	23
PCM501	Rotating Sand Table	2 - 5	2	0'0"	2'1"	-	0'0" x 0'0"	1.1	37
PCM502	Sand Desk with Seats	2 - 5	3	0'0"	1'5"	-	0'0" x 0'0"	2.7	88
PCM503	Sandpit	2 - 5	8	0'0"	1'0"	-	0'0" x 0'0"	3	93
BASIC550	Sandbox	2 - 5	6	0'0"	1'0"	-	0'0" x 0'0"	3.6	187



# THEMED PLAY

## Familiar, Child-Sized Spaces in a Big World

KOMPAN's themed play elements encourage dramatic play in children, which in turn stimulates the child's language development and cognition.



**For a greener future**  
Post-consumer recycled materials:  
EcoCore™ Panels

>95%



Toddler Train  
M536



Orient Express  
M241



Pullman Bench  
M242



Toddler Train Carriage  
M537



Truck  
KPL502

## PRODUCT INFORMATION

Product number	Product name	Age (years)	Capacity (users)	Fall height (ft & in)	Total height (ft & in)	Use zone dimensions (ft <sup>2</sup> )	Use zone dimensions (ft & in x ft & in)	Installation (hours)	Total CO <sub>2</sub> e (kg CO <sub>2</sub> e)
M536	Toddler Train	6m - 4	4	1'7"	4'3"	213	16'8" x 15'0"	5.3	152
M241	Orient Express	2 - 5	4	0'0"	3'1"	-	0'0" x 0'0"	3.7	92
M242	Pullman Bench	2 - 5	4	0'0"	3'1"	-	0'0" x 0'0"	3.7	92
M537	Toddler Train Carriage	6m - 4	3	1'7"	4'4"	195	15'2" x 15'2"	5	148
KPL502	Truck	2 - 5	6	1'9"	4'3"	216	16'4" x 15'4"	6.1	192





Steam Engine

M525



ADD TRAIN  
COUPLING



Railway Carriage

M526



Mini Car

M531



Truck

M534



Fire Engine

M535



Mars Rover

PCM516



## PRODUCT INFORMATION

Product number	Product name	Age (years)	Capacity (users)	Fall height (ft & in)	Total height (ft & in)	Use zone dimensions (ft <sup>2</sup> )	Use zone dimensions (ft & in x ft & in)	Installation (hours)	Total CO <sub>2</sub> e (kg CO <sub>2</sub> e)
M525	Steam Engine	2 - 5	8	0'11"	5'5"	313	21'6" x 15'11"	10	450
M526	Railway Carriage	2 - 5	8	1'9"	5'5"	318	21'9" x 16'11"	12	535
M529	Coupling	2 - 5	1	0'11"	0'11"	150	13'10" x 13'10"	1.4	35
M531	Mini Car	2 - 5	6	1'6"	3'3"	243	15'5" x 17'9"	5.6	220
M534	Truck	2 - 5	8	2'12"	6'3"	321	17'2" x 20'11"	13	578
M535	Fire Engine	2 - 5	8	2'12"	6'3"	321	15'6" x 21'0"	16	739
PCM516	Mars Rover	2 - 5	4	2'4"	4'0"	248	18'1" x 15'5"	7.4	426



# PLAYHOUSES AND THEMED PLAY

## Familiar, Child-Sized Spaces in a Big World

The smaller-scale open playhouses are a strong play motivator for the youngest. The openness of the play space allows many children to play together from the inside and the outside. It's the first stage of forming a community.

From the Villa to the Allotment, themed playground playhouses open doors to understanding the value of friendship and imaginative play.



**For a greener future**  
Post-consumer recycled materials:  
EcoCore™ Panels

>95%



Villa Playhouse  
M7000



Toddler Garden House  
M410



Toddler flower house  
M411



Crocodile Bench  
M243



Jumbo Bench  
M240



Triple Shifter  
M7021



## PRODUCT INFORMATION

Product number	Product name	Age (years)	Capacity (users)	Fall height (ft & in)	Total height (ft & in)	Use zone dimensions (ft <sup>2</sup> )	Use zone dimensions (ft & in x ft & in)	Installation (hours)	Total CO <sub>2</sub> e (kg CO <sub>2</sub> e)
M7000	Villa Playhouse	2 - 5	12	0'0"	4'9"	-	0'0" x 0'0"	7.5	218
M410	Toddler Garden House	6m - 4	8	0'0"	3'11"	-	0'0" x 0'0"	5.8	127
M411	Toddler flower house	6m - 4	8	0'0"	3'11"	-	0'0" x 0'0"	5.7	126
M243	Crocodile Bench	2 - 5	4	0'0"	2'2"	-	0'0" x 0'0"	2.5	63
M240	Jumbo Bench	2 - 5	6	0'0"	3'1"	-	0'0" x 0'0"	4.4	150
M7021	Triple Shifter	2 - 5	7	4'7"	7'1"	279	17'11" x 20'1"	8.6	421





# Visualize Your Outdoor Activity Area

Are you considering your options for an outdoor activity area? ImaginIt, the KOMPAN augmented reality app, lets you visualize how different styles and themes fit your chosen area.

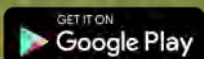



# TODDLER PLAY EQUIPMENT

## A Stimulated Toddler is a Happy Toddler

The happiest toddlers are those who experience age-appropriate stimulation and challenges. The playful designs in our Toddler Equipment collection draw on familiar connotations and invite children to engage in dramatic, developmental play.

Whether climbing the tallest giraffe or driving a pretend car, our toddler universe gently stimulates and guides the little ones to understand the world around them.



Forest Giraffe  
MSC5416



### For a greener future

#### Post-consumer recycled materials:

EcoCore™ Panels	>95%
Hollow Plastic Parts	33%
TexMade™ Posts	>95%

Steel parts adhere to industrial standards



Coupe Deluxe  
MSC5414



Cottage Deluxe  
MSC5415



Toddler Spica  
M191



Sunflower  
M951



Little Duckling  
M188



Little Elephant  
M189

## PRODUCT INFORMATION

Product number	Product name	Age (years)	Capacity (users)	Fall height (ft & in)	Total height (ft & in)	Use zone dimensions (ft²)	Use zone dimensions (ft & in x ft & in)	Installation (hours)	Total CO <sub>2</sub> e (kg CO <sub>2</sub> e)
MSC5416	Forest Giraffe	6m - 4	11	1'10"	4'6"	242	17'11" x 15'10"	7.6	137
MSC5414	Coupe Deluxe	6m - 4	8	0'0"	3'11"	-	0'0" x 0'0"	7.7	137
MSC5415	Cottage Deluxe	6m - 4	8	0'0"	4'7"	-	0'0" x 0'0"	8.1	141
M191	Toddler Spica	6m - 4	1	1'12"	3'2"	143	13'6" x 13'6"	1.8	70
M951	Sunflower	6m - 2	1	2'7"	4'6"	83	9'8" x 15'7"	3.3	132
M188	Little Duckling	6m - 2	1	1'1"	1'11"	145	12'11" x 14'2"	2.2	46
M189	Little Elephant	6m - 4	1	1'3"	2'10"	154	13'4" x 14'8"	2.6	62



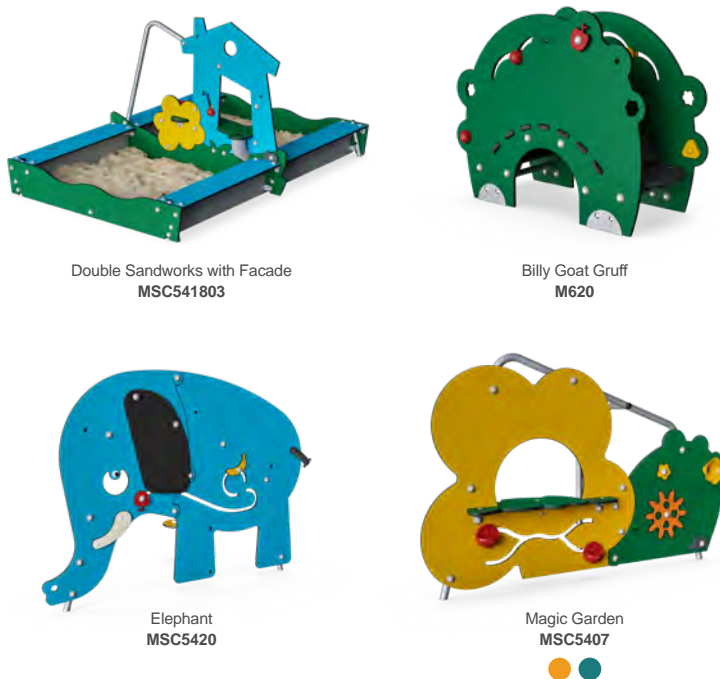
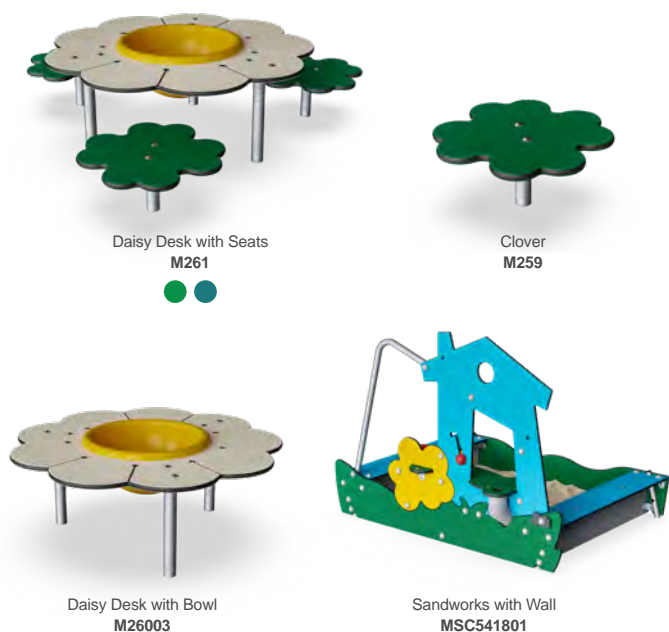

## PRODUCT INFORMATION

Product number	Product name	Age (years)	Capacity (users)	Fall height (ft & in)	Total height (ft & in)	Use zone dimensions (ft <sup>2</sup> )	Use zone dimensions (ft & in x ft & in)	Installation (hours)	Total CO <sub>2</sub> e (kg CO <sub>2</sub> e)
M261	Daisy Desk with Seats	6m - 4	3	0'0"	1'4"	-	0'0" x 0'0"	2.6	90
M259	Clover	6m - 4	1	0'0"	0'8"	-	0'0" x 0'0"	1.2	12
M26003	Daisy Desk with Bowl	6m - 4	3	0'0"	1'3"	-	0'0" x 0'0"	1.8	54
MSC541801	Sandworks with Wall	6m - 4	10	0'0"	4'4"	-	0'0" x 0'0"	7	127
MSC541803	Double Sandworks with Facade	6m - 4	16	0'0"	4'4"	-	0'0" x 0'0"	9.1	181
M620	Billy Goat Gruff	6m - 4	2	1'5"	3'2"	184	13'6" x 16'1"	3.6	100
MSC5420	Elephant	6m - 4	4	0'0"	4'7"	-	0'0" x 0'0"	4.2	78
MSC5407	Magic Garden	6m - 4	4	0'0"	3'11"	-	0'0" x 0'0"	4.8	89



# TODDLER PLAY EQUIPMENT

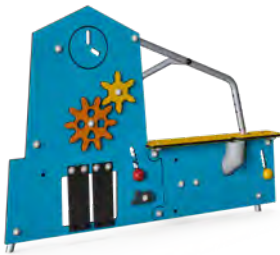

Creative Workshop  
MSC5408

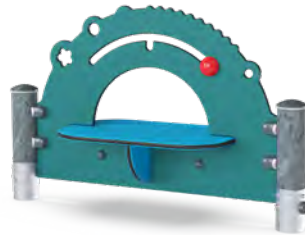

Talk & Tumble Counter  
PCM000121

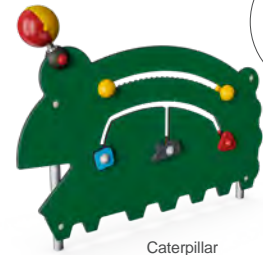

Caterpillar  
MSC5406

FOR  
SUPERVISED  
AREAS ONLY



Cloud Climber  
MSC5401



Mini Hammock  
PCM804



Tick-Tock  
M631

## PRODUCT INFORMATION

Product number	Product name	Age (years)	Capacity (users)	Fall height (ft & in)	Total height (ft & in)	Use zone dimensions (ft <sup>2</sup> )	Use zone dimensions (ft & in x ft & in)	Installation (hours)	Total CO <sub>2</sub> e (kg CO <sub>2</sub> e)
PCM154	Toddler Carousel	2 - 5	3	4'11"	7'9"	795	31'10" x 31'10"	3.8	461
MSC5408	Creative Workshop	6m - 4	4	0'0"	4'1"	-	0'0" x 0'0"	4.9	79
PCM000121	Talk & Tumble Counter	6m - 4	4	0'0"	2'6"	-	0'0" x 0'0"	3.1	55
MSC5406	Caterpillar	6m - 4	3	0'0"	3'0"	-	0'0" x 0'0"	2.9	53
MSC5401	Cloud Climber	2 - 5	2	2'4"	4'1"	197	17'5" x 14'6"	3.2	74
PCM804	Mini Hammock	2 - 5	1	0'9"	2'6"	167	15'11" x 13'4"	2.7	89
M631	Tick-Tock	6m - 4	2	0'0"	2'0"	-	0'0" x 0'0"	1.8	28





Peekaboo Tunnel  
PCM002921



Garden Table  
M230



Fence  
MSC5404

FOR  
SUPERVISED  
AREAS ONLY



Labyrinth, 2 Rooms  
M63272



Labyrinth, 3 Rooms  
M63273



Labyrinth, 4 Rooms  
M63274

## PRODUCT INFORMATION

Product number	Product name	Age (years)	Capacity (users)	Fall height (ft & in)	Total height (ft & in)	Use zone dimensions (ft <sup>2</sup> )	Use zone dimensions (ft & in x ft & in)	Installation (hours)	Total CO <sub>2</sub> e (kg CO <sub>2</sub> e)
PCM002921	Peekaboo Tunnel	2 - 12	3	0'6"	3'3"	205	13'9" x 17'2"	4.6	181
M230	Garden Table	2 - 5	6	0'0"	1'9"	-	0'0" x 0'0"	3.5	154
MSC5404	Fence	6m - 4	-	0'0"	2'4"	-	0'0" x 0'0"	2.2	33
M63272	Labyrinth, 2 Rooms	6m - 4	6	0'0"	4'6"	-	0'0" x 0'0"	6.8	168
M63273	Labyrinth, 3 Rooms	6m - 4	8	0'0"	4'6"	-	0'0" x 0'0"	9.5	265
M63274	Labyrinth, 4 Rooms	6m - 4	10	0'0"	4'6"	-	0'0" x 0'0"	10	280



# TODDLER STATIONS

## Themed Play Stations for Play and Learning

Toddler stations mimic real-life environments and appeal to infant and toddler curiosity: lots of details to explore and play at eye level. Play panels stimulate their creative and cognitive skills and provide the opportunity to play from all sides.

The toddler stations are placed on top of the surface without fixation to the ground, making it a movable, flexible solution for indoor or outdoor use.

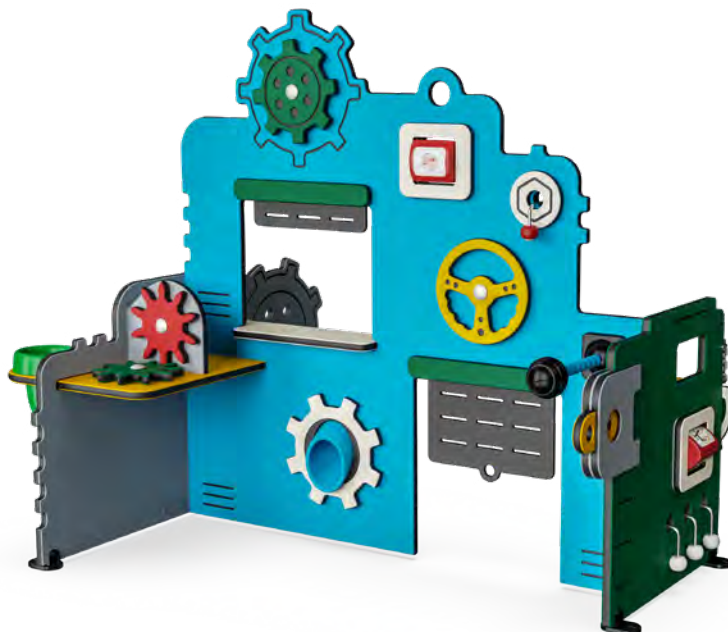

Service & Workshop  
MSV602



### For a greener future

Post-consumer recycled materials:

EcoCore™ Panels  
Hollow Plastic Parts

>95%  
33%

Steel parts adhere to industrial standards



Low Slope  
MSV605



Steep Slope  
MSV606

## PRODUCT INFORMATION

All products are for supervised areas only.

Product number	Product name	Age (years)	Capacity (users)	Fall height (ft & in)	Total height (ft & in)	Use zone dimensions (ft²)	Use zone dimensions (ft & in x ft & in)	Installation (hours)	Total CO <sub>2</sub> e (kg CO <sub>2</sub> e)
MSV602	Service & Workshop	6m - 4	8	0'0"	3'12"	-	0'0" x 0'0"	6.1	53
MSV605	Low Slope	6m - 4	2	0'11"	1'3"	187	15'11" x 13'10"	3.4	34
MSV606	Steep Slope	6m - 4	2	1'4"	1'8"	187	15'11" x 13'10"	3.5	40





Home & Garden  
MSV601



Shop & Kitchen  
MSV603



Greenhouse & Florist  
MSV604



Block Seat  
MSV201



## PRODUCT INFORMATION

All products are for supervised areas only.

Product number	Product name	Age (years)	Capacity (users)	Fall height (ft & in)	Total height (ft & in)	Use zone dimensions (ft <sup>2</sup> )	Use zone dimensions (ft & in x ft & in)	Installation (hours)	Total CO <sub>2</sub> e (kg CO <sub>2</sub> e)
MSV601	Home & Garden	6m - 4	8	0'0"	3'12"	-	0'0" x 0'0"	5.9	51
MSV603	Shop & Kitchen	6m - 4	8	0'0"	3'12"	-	0'0" x 0'0"	6.3	63
MSV604	Greenhouse & Florist	6m - 4	8	0'0"	3'12"	-	0'0" x 0'0"	5.1	62
MSV201	Block Seat	6m - 4	1	0'0"	1'0"	-	0'0" x 0'0"	0.6	5



# PLAY PANELS

## That Little Extra Fun for Play and Learning

In free play, children learn by following their instincts, developing fundamental human skills. Adding play panels to your playground structure creates a learning dimension to the play experience. Through music and themed play panels, children learn about different topics.

And yes, adults can join the play and guide the children to learn new things while having fun, too.



### For a greener future

Post-consumer recycled materials:

EcoCore™ Panels  
TexMade™ Posts

>95%  
>95%

Steel parts adhere to industrial standards

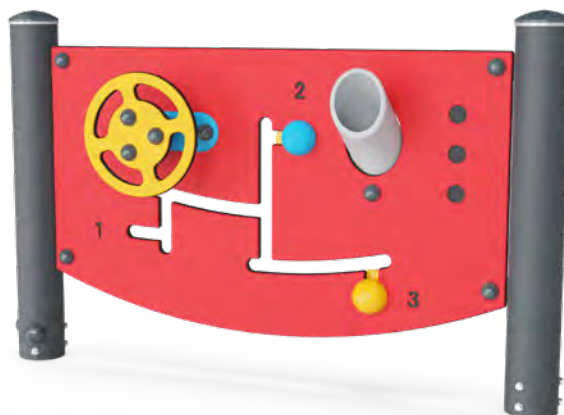

Play Panel 1 - Creative  
PCM000621



Play Panel 1 - Music  
PCM000721



Chalk Board, Large  
PCM0012



Magnetic White Board  
PCM0013



Play Panel 2 - Music, Classic  
PCM003121



Play Panel 2 - Emotion, Classic  
PCM003221



Play Panel 3 - Learning, Classic  
PCM003321



Play Panel 4 - School  
PCM003421



## PRODUCT INFORMATION

Emission: Standard version / Greenest version

Product number	Product name	Age (years)	Capacity (users)	Fall height (ft & in)	Total height (ft & in)	Use zone dimensions (ft <sup>2</sup> )	Use zone dimensions (ft & in x ft & in)	Installation (hours)	Total CO <sub>2</sub> e (kg CO <sub>2</sub> e)
PCM000621	Play Panel 1 - Creative	6m - 5	4	0'0"	2'6"	-	0'0" x 0'0"	3.6	82 / 66
PCM000721	Play Panel 1 - Music	6m - 5	4	0'0"	2'6"	-	0'0" x 0'0"	2.9	116 / 97
PCM0012	Chalk Board, Large	2 - 8	4	0'0"	4'7"	-	0'0" x 0'0"	3.8	125 / 103
PCM0013	Magnetic White Board	2 - 8	4	0'0"	4'7"	-	0'0" x 0'0"	3.8	125 / 103
PCM003121	Play Panel 2 - Music, Classic	6m - 5	7	0'0"	3'0"	-	0'0" x 0'0"	4.9	176 / 147
PCM003221	Play Panel 2 - Emotion, Classic	6m - 5	9	0'0"	2'11"	-	0'0" x 0'0"	6.1	138 / 111
PCM003321	Play Panel 3 - Learning, Classic	6m - 5	10	0'0"	2'6"	-	0'0" x 0'0"	6.7	172 / 137
PCM003421	Play Panel 4 - School	6m - 5	14	0'0"	2'6"	-	0'0" x 0'0"	7.5	234 / 191



# FLEXIBILITY

With a variety of colors and part options, we offer lots of flexibility and customization with our standard products.

## Physical Play



## Social & Emotional Play



## Creative & Cognitive Play

### Construction



### Auditive Play



### Rule Play



# OPTIONS



PRODUCT CONFIGURATOR  
www.kompan.com

Angles: 0° - 45° - 90°



Color concepts



Posts

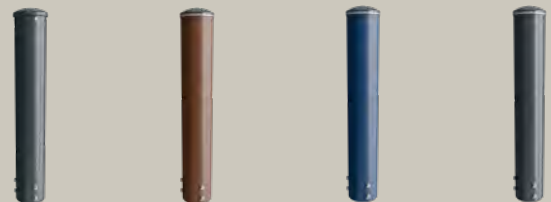

Anthracite steel

Brown steel

Dark blue steel

Black aluminium



Impregnated pine wood

TexMade™

TexMade™ posts for the lowest possible carbon emissions factor are available for all versions of the play system.

## More flexibility

Contact us for more information on the wide range of options for configurable playground equipment. Please note that prices and delivery terms depend on specified configurations.



# ZIPLINES

## The King of Fun, Thrill, and Action

The line for the cableway is always long! Whether you're four or twelve, the cableway is just great fun. Besides being fun, the cableway teaches children several important lessons and skills. They learn to wait their turn and hand over the seat to the next in line.

All across schools and parks, one look at all the children lined up for playground cableways, and you can understand why. What a ride!



### For a greener future

Post-consumer recycled materials:

Molded Decks 75%  
TexMade™ Posts >95%

Extruded aluminium made with low-carbon aluminium  
Steel parts adhere to industrial standards



Cableway Start Platform  
PCM114431



Double Zipline, Flat Space  
M88102



Double Zipline, Sloped Space  
M88101

## PRODUCT INFORMATION

Product number	Product name	Age (years)	Capacity (users)	Fall height (ft & in)	Total height (ft & in)	Use zone dimensions (ft²)	Use zone dimensions (ft & in x ft & in)	Installation (hours)	Total CO <sub>2</sub> e (kg CO <sub>2</sub> e)
PCM114431	Cableway Start Platform	5 - 12	-	2'11"	6'7"	318	22'5" x 15'11"	7.6	462
M88102	Double Zipline, Flat Space	5 - 12	2	6'11"	13'0"	2626	122'3" x 30'5"	18	1,950
M88101	Double Zipline, Sloped Space	5 - 12	2	6'11"	9'9"	2551	121'0" x 28'6"	18	1,804



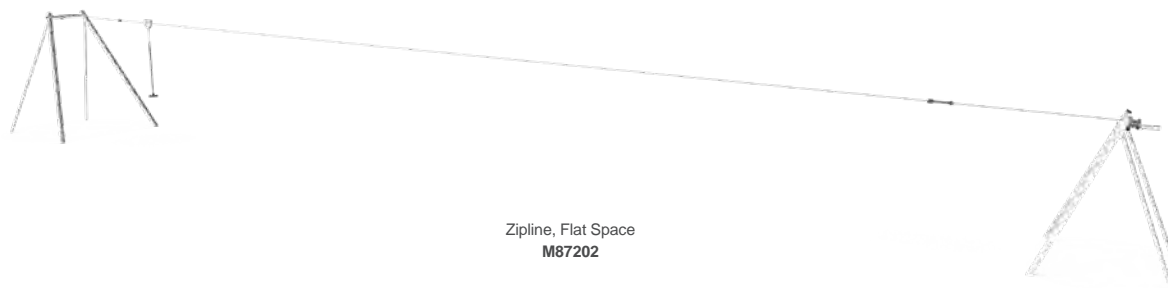

Zipline, Flat Space  
M87202

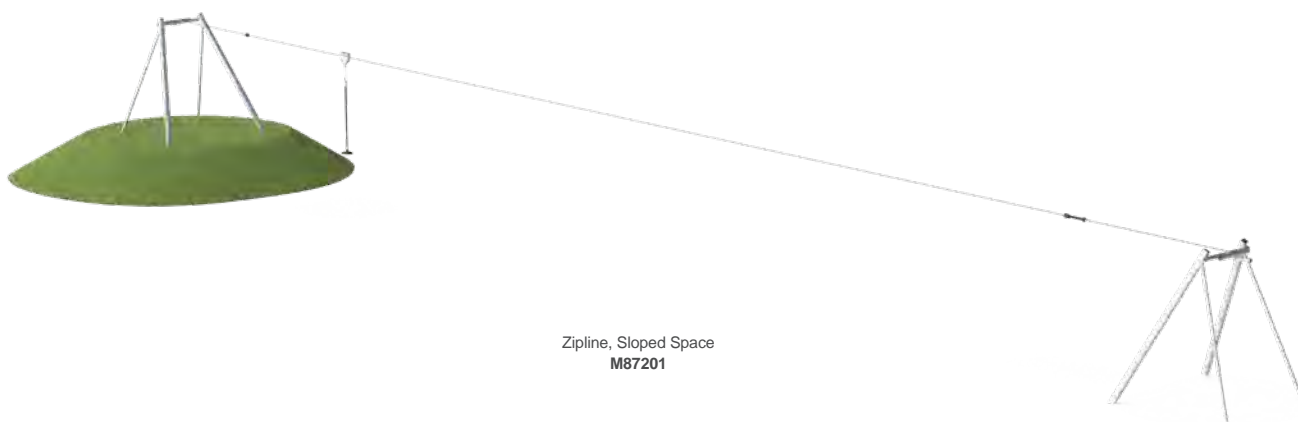

Zipline, Sloped Space  
M87201

## PRODUCT INFORMATION

Product number	Product name	Age (years)	Capacity (users)	Fall height (ft & in)	Total height (ft & in)	Use zone dimensions (ft <sup>2</sup> )	Use zone dimensions (ft & in x ft & in)	Installation (hours)	Total CO <sub>2</sub> e (kg CO <sub>2</sub> e)
M87202	Zipline, Flat Space	5 - 12	1	6'11"	12'11"	1812	122'2" x 23'9"	11	1,015
M87201	Zipline, Sloped Space	5 - 12	1	6'11"	9'8"	1739	120'11" x 21'10"	10	923



# MEETING POINTS

## Comfortable Hangout Spots

As children grow older, they become more interested in social play and interaction. Comfortable meeting points should be available in any school playground. Our Meeting Point solutions cater to small and large impromptu social gatherings and offer a place to relax.

Meeting Points are comfortable hang-out spots for a chat or a break, whether on the swaying hammock or the bench.



### For a greener future

#### Post-consumer recycled materials:

EcoCore™ Panels  
Hollow Plastic Parts

>95%  
33%

Steel parts adhere to industrial standards



Meeting Point with Movable Hammocks  
PCM704



Movable Hammocks  
PCM701



Meeting Point  
PCM702



Meeting Point with Bench  
PCM703

## PRODUCT INFORMATION

Product number	Product name	Age (years)	Capacity (users)	Fall height (ft & in)	Total height (ft & in)	Use zone dimensions (ft²)	Use zone dimensions (ft & in x ft & in)	Installation (hours)	Total CO <sub>2</sub> e (kg CO <sub>2</sub> e)
PCM704	Meeting Point with Movable Hammocks	5 - 12	12	1'11"	9'6"	433	22'10" x 23'4"	11	918
PCM701	Movable Hammocks	5 - 12	6	1'11"	2'2"	315	23'0" x 18'8"	5.2	423
PCM702	Meeting Point	5 - 12	2	0'0"	5'7"	-	0'0" x 0'0"	3	142
PCM703	Meeting Point with Bench	5 - 12	6	0'0"	5'7"	-	0'0" x 0'0"	5.6	337





Hammock with Galvanized Posts  
**PCM805**



Cosmos Meeting Point  
**FRE3000**



Crescent 40  
**FRE3010**



AVAILABLE  
IN TWO  
HEIGHTS



CometTail 40  
**FRE3012**



Outdoor Play Timer  
**PCM201**

## PRODUCT INFORMATION

Product number	Product name	Age (years)	Capacity (users)	Fall height (ft & in)	Total height (ft & in)	Use zone dimensions (ft <sup>2</sup> )	Use zone dimensions (ft & in x ft & in)	Installation (hours)	Total CO <sub>2</sub> e (kg CO <sub>2</sub> e)
<b>PCM805</b>	Hammock with Galvanized Posts	5 - 12	2	4'2"	4'6"	294	25'0" x 14'6"	1.2	204
<b>FRE3000</b>	Cosmos Meeting Point	3+	-	0'0"	8'8"	-	0'0" x 0'0"	8.4	716
<b>FRE3010</b>	Crescent 40	3+	-	0'0"	1'4"	-	0'0" x 0'0"	1.9	69
<b>FRE3012</b>	CometTail 40	3+	-	0'0"	1'4"	-	0'0" x 0'0"	1.9	69
<b>PCM201</b>	Outdoor Play Timer	5 - 12	4	0'0"	4'2"	43	7'4" x 6'8"	2.4	79



# SIGNS

## Customizable Signage

Signs are an essential way to make relevant information available for the users of private or public areas. E.g., general or practical information or instructions about the use of a playground, opening hours, ideal user or age groups, sponsors, or contact information.

Our customizable signage is flexible regarding text, signs, and symbols, enabling you to deliver the right message.



Moments Sign M  
PCM202



**For a greener future**  
Post-consumer recycled materials:  
TexMade™ Posts >95%  
Steel parts adhere to industrial standards



Moments Sign L  
PCM203



Moments Sign XL  
PCM204



Sign Medium  
PAR3003



Sign Large  
PAR3004



Sign X-Large  
PAR3005



Robinia Sign Medium  
NRO217



Robinia Sign Large  
NRO218



Robinia Sign X-Large  
NRO219

## PRODUCT INFORMATION

Emission: Standard version / TexMade™ version

Product number	Product name	Age (years)	Capacity (users)	Fall height (ft & in)	Total height (ft & in)	Use zone dimensions (ft²)	Use zone dimensions (ft & in x ft & in)	Installation (hours)	Total CO <sub>2</sub> e (kg CO <sub>2</sub> e)
PCM202	Moments Sign M	-	-	0'0"	3'7"	-	0'0" x 0'0"	1.5	79 / 49
PCM203	Moments Sign L	-	-	0'0"	4'11"	-	0'0" x 0'0"	1.6	106 / 64
PCM204	Moments Sign XL	-	-	0'0"	7'1"	-	0'0" x 0'0"	2.5	191 / 133
PAR3003	Sign Medium	-	-	0'0"	3'5"	-	0'0" x 0'0"	0.6	50 / -
PAR3004	Sign Large	-	-	0'0"	4'9"	-	0'0" x 0'0"	0.7	70 / -
PAR3005	Sign X-Large	-	-	0'0"	6'9"	-	0'0" x 0'0"	1.1	137 / -
NRO217	Robinia Sign Medium	-	-	0'0"	3'9"	-	0'0" x 0'0"	1.7	23 / 23
NRO218	Robinia Sign Large	-	-	0'0"	5'1"	-	0'0" x 0'0"	2	38 / 38
NRO219	Robinia Sign X-Large	-	-	0'0"	7'3"	-	0'0" x 0'0"	3.1	93 / 93



# FLEXIBILITY

With a variety of colors and part options, we offer lots of flexibility and customization with our standard products.

## Custom Sign Design

1. Select sign size and material
2. Create sign graphics for KOMPAN
3. Supply and installation



# OPTIONS



PRODUCT CONFIGURATOR  
www.kompan.com

## Robinia wood



- Untreated wood
- Brown pigmented wood

## Outdoor furniture steel\*



## Posts



Black aluminium

Steel\*

\*) Steel colors



Impregnated pine wood

TexMade™

TexMade™ posts for the lowest possible carbon emissions factor are available for all versions of the play system.

## More flexibility

Contact us for more information on the wide range of options for configurable equipment. Please note that prices and delivery terms depend on specified configurations.



# PORTAL SWINGS

## Swings Children Keep Coming Back To

Of all play activities, swinging is a favorite. Apart from being great fun, swinging trains children's agility, balance, coordination, and spatial awareness. These motor skills are crucial to judging distances and navigating traffic safely.

Whether it's for a quiet moment alone or swinging with a group of friends, children love to swing.

See options on the FLEXIBILITY page.



Swing, 3 seat, 8 ft H, 1 Shell Seat  
**KSW92009**



Swing, 8 ft H  
**KSW92003**



Swing, 8 ft H, 1 Shell Seat  
**KSW92007**





**For a greener future**  
Post-consumer recycled materials:  
Hollow Plastic Parts 33%  
Steel parts adhere to industrial standards

## PRODUCT INFORMATION

Product number	Product name	Age (years)	Capacity (users)	Fall height (ft & in)	Total height (ft & in)	Use zone dimensions (ft <sup>2</sup> )	Use zone dimensions (ft & in x ft & in)	Installation (hours)	Total CO <sub>2</sub> e (kg CO <sub>2</sub> e)
<b>KSW92009</b>	Swing, 3 seat, 8 ft H, 1 Shell Seat	2 - 12	8	7'11"	8'4"	850	33'11" x 31'8"	7.1	754
<b>KSW92011</b>	Swing, 8 ft H, 1 Rope Seat	2 - 12	9	7'11"	8'4"	850	33'11" x 31'8"	7.5	843
<b>KSW92003</b>	Swing, 8 ft H	2 - 12	2	7'11"	8'4"	549	23'10" x 31'8"	4.9	437
<b>KSW92007</b>	Swing, 8 ft H, 1 Shell Seat	2 - 12	6	7'9"	8'4"	495	22'6" x 30'10"	4.3	477
<b>KSW92001</b>	Swing, 7ft H	2 - 12	2	6'3"	6'9"	468	23'10" x 25'1"	4.7	399
<b>KSW92005</b>	Swing, 10 ft H	2 - 12	2	9'7"	10'0"	630	23'10" x 38'2"	4.9	476
<b>KSW92008</b>	Swing, 8 ft H, 1 Rope Seat	2 - 12	6	7'9"	8'4"	495	22'6" x 30'10"	4.5	566





Swing Frame, 1 Seat, 8 ft H  
**KSW921**

SEAT OPTIONS  
PAGE 174



Swing Frame, 2 Seat, 8 ft H  
**KSW922**



Swing Frame, 3 Seat, 8 ft H  
**KSW923**



Swing Frame, 4 Seat, 8 ft H  
**KSW924**



Swing Frame, 5 Seat, 8 ft H  
**KSW925**



Swing Frame, 6 Seat, 8 ft H  
**KSW926**

## PRODUCT INFORMATION

Product number	Product name	Age (years)	Capacity (users)	Fall height (ft & in)	Total height (ft & in)	Use zone dimensions (ft <sup>2</sup> )	Use zone dimensions (ft & in x ft & in)	Installation (hours)	Total CO <sub>2</sub> e (kg CO <sub>2</sub> e)
<b>KSW921</b>	Swing Frame, 1 Seat, 8 ft H	2 - 12	-	0'0"	8'4"	-	0'0" x 0'0"	4.4	383
<b>KSW922</b>	Swing Frame, 2 Seat, 8 ft H	2 - 12	-	0'0"	8'4"	-	0'0" x 0'0"	4.7	415
<b>KSW923</b>	Swing Frame, 3 Seat, 8 ft H	2 - 12	-	0'0"	8'4"	-	0'0" x 0'0"	6.6	638
<b>KSW924</b>	Swing Frame, 4 Seat, 8 ft H	2 - 12	-	0'0"	8'4"	-	0'0" x 0'0"	7	670
<b>KSW925</b>	Swing Frame, 5 Seat, 8 ft H	2 - 12	-	0'0"	8'4"	-	0'0" x 0'0"	8.9	893
<b>KSW926</b>	Swing Frame, 6 Seat, 8 ft H	2 - 12	-	0'0"	8'4"	-	0'0" x 0'0"	9.3	925
<b>KSW928</b>	Swing Frame, 8 Seat, 8 ft H	2 - 12	-	0'0"	8'5"	-	0'0" x 0'0"	12	1,180
<b>KSW9210</b>	Swing Frame, 10 Seat, 8 ft H	2 - 12	-	0'0"	8'5"	-	0'0" x 0'0"	14	1,452
<b>KSW9212</b>	Swing Frame, 12 Seat, 8 ft H	2 - 12	-	0'0"	8'5"	-	0'0" x 0'0"	16	1,707



# SWING SEATS

## A Swing for Every Need and Ability

We want everyone to enjoy the thrill of swinging. Our wide range of swings cater to various abilities and age groups. We offer everything from a baby swing seat to a five-way swing solution and an inclusive swing seat.

The Bird's Nest is popular with tweens and the You & Me Swing is perfect for sharing the swinging experience with caregivers.



Inclusive Seat, 8 ft H, 2-Chain  
SW990205





**For a greener future**  
Post-consumer recycled materials:  
Hollow Plastic Parts 33%  
Steel parts adhere to industrial standards



Swing Seat, Stainless  
SW990011



Baby Seat, 8 ft  
SW990023



Toddler Swing Seat, 8 ft  
SW990031



Shell Nest, 47 in wide, 8 ft  
SW990091



Rope Nest, 47 in wide  
SW990111



Duo Swing Seat  
SW990201



You & Me Swing Seat  
SW990131



## PRODUCT INFORMATION

Seats are available for other swing heights.

Product number	Product name	Age (years)	Capacity (users)	Fall height (ft & in)	Total height (ft & in)	Use zone dimensions (ft <sup>2</sup> )	Use zone dimensions (ft & in x ft & in)	Installation (hours)	Total CO <sub>2</sub> e (kg CO <sub>2</sub> e)
SW990205	Inclusive Seat, 8 ft H, 2-Chain	5 - 12	1	0'0"	0'0"	-	0'0" x 0'0"	0.4	56
SW990011	Swing Seat, Stainless	2+	1	7'11"	0'0"	212	6'9" x 31'8"	0.1	21
SW990023	Baby Seat, 8 ft	1+	1	7'11"	0'0"	170	6'7" x 25'11"	0.1	22
SW990031	Toddler Swing Seat, 8 ft	1+	1	8'0"	0'0"	357	6'7" x 32'2"	1.3	65
SW990091	Shell Nest, 47 in wide, 8 ft	2+	7	7'9"	0'0"	296	9'7" x 30'10"	0.5	110
SW990111	Rope Nest, 47 in wide	2+	7	7'9"	0'0"	299	9'7" x 30'10"	0.5	190
SW990201	Duo Swing Seat	2+	2	7'9"	0'0"	287	9'4" x 30'10"	0.3	48
SW990131	You & Me Swing Seat	1+	2	7'9"	0'0"	277	9'4" x 30'10"	0.4	73



# UNIQUE SWINGS

## Swinging Together – the More, the Merrier!

Not only is swinging the most popular activity for playful children, but swinging together is an irresistible invitation for all children to play – and simultaneously train vital skills. The socio-emotional effect of swinging together cannot be overestimated.

The soothing or wild swing movements create a joyous thrill, laughter, or relaxation, whether swinging together or alone.



Cocowave Pendulum Swing  
M984



### For a greener future

Post-consumer recycled materials:

Hercules Rope Yarn

>95%

Steel parts adhere to industrial standards



## PRODUCT INFORMATION

Product number	Product name	Age (years)	Capacity (users)	Fall height (ft & in)	Total height (ft & in)	Use zone dimensions (ft <sup>2</sup> )	Use zone dimensions (ft & in x ft & in)	Installation (hours)	Total CO <sub>2</sub> e (kg CO <sub>2</sub> e)
M984	Cocowave Pendulum Swing	5 - 12	8	9'7"	11'11"	692	39'9" x 20'10"	9.6	1,247



# CLASSIC SWINGS

## The Classic Swing Never Grows Old

To swing is a classic play activity, as is the design of KOMPAN's classic swings. The traditional look makes it the preferred design in many playground settings. You can construct your swing solution from our wide range of swing seats with as many sections as possible.

The standard swing and baby seats can include anti-wrap clamps to prevent the chains from turning.

See options on the FLEXIBILITY page.



Combi Swing, 39 in wide, 8 ft H  
KSW93045



### For a greener future

#### Post-consumer recycled materials:

Hollow Plastic Parts  
TexMade™ Posts

33%  
>95%

Steel parts adhere to industrial standards



Swing, 8 ft H, Std. Seats  
KSW93014



Swing, 8 ft H, Shell Seat  
KSW93040

## PRODUCT INFORMATION

Emission: Standard version / Greenest version

Product number	Product name	Age (years)	Capacity (users)	Fall height (ft & in)	Total height (ft & in)	Use zone dimensions (ft <sup>2</sup> )	Use zone dimensions (ft & in x ft & in)	Installation (hours)	Total CO <sub>2</sub> e (kg CO <sub>2</sub> e)
KSW93045	Combi Swing, 39 in wide, 8 ft H	2 - 12	2	7'11"	9'0"	902	35'8" x 31'8"	7.2	686 / 632
KSW93014	Swing, 8 ft H, Std. Seats	2 - 12	2	7'11"	9'0"	603	25'12" x 31'8"	5	388 / 352
KSW93040	Swing, 8 ft H, Shell Seat	2 - 12	6	7'9"	9'0"	540	23'11" x 30'10"	4.4	425 / 392





1-Seat Frame, 8 ft H, Steel  
**KSW931**



3-Seat Frame, 8 ft H, Steel  
**KSW933**



5-Seat Frame, 8 ft H, Steel  
**KSW935**



2-Seat Frame, 8 ft H, Steel  
**KSW932**



4-Seat Frame, 8 ft H, Steel  
**KSW934**



6-Seat Frame, 8 ft H, Steel  
**KSW936**

SEAT OPTIONS  
PAGE 174

## PRODUCT INFORMATION

Product number	Product name	Age (years)	Capacity (users)	Fall height (ft & in)	Total height (ft & in)	Use zone dimensions (ft <sup>2</sup> )	Use zone dimensions (ft & in x ft & in)	Installation (hours)	Total CO <sub>2</sub> e (kg CO <sub>2</sub> e)
<b>KSW931</b>	1-Seat Frame, 8 ft H, Steel	2 - 12	-	0'0"	8'11"	384	22'1" x 19'10"	4.4	335
<b>KSW933</b>	3-Seat Frame, 8 ft H, Steel	2 - 12	-	0'0"	8'11"	581	33'7" x 19'10"	6.7	574
<b>KSW935</b>	5-Seat Frame, 8 ft H, Steel	2 - 12	-	0'0"	8'11"	783	45'2" x 19'10"	9	812
<b>KSW932</b>	2-Seat Frame, 8 ft H, Steel	2 - 12	-	0'0"	8'11"	431	25'12" x 19'10"	4.8	366
<b>KSW934</b>	4-Seat Frame, 8 ft H, Steel	2 - 12	-	0'0"	8'11"	633	37'7" x 19'10"	7.2	605
<b>KSW936</b>	6-Seat Frame, 8 ft H, Steel	2 - 12	-	0'0"	8'11"	835	49'1" x 19'10"	9.5	843
<b>KSW938</b>	8-Seat Frame, 8 ft H, Steel	2 - 12	-	0'0"	8'11"	1038	60'8" x 19'10"	12	1,082
<b>KSW9310</b>	10-Seat Frame, 8 ft H, Steel	2 - 12	-	0'0"	8'11"	1239	72'3" x 19'10"	14	1,320
<b>KSW9312</b>	12-Seat Frame, 8 ft H, Steel	2 - 12	-	0'0"	8'11"	1441	83'10" x 19'10"	17	1,559



# FLEXIBILITY

With a variety of colors and part options, we offer lots of flexibility and customization with our standard products.



Steel



TexMade™



From 1 seat...



...to 12 seats



Steel

Steel colors



From 1 seat...



...to 12 seats



# OPTIONS



PRODUCT CONFIGURATOR  
www.kompan.com

## Swing seats



Baby



Toddler

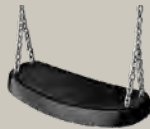

All ages



You & Me



Duo



Inclusive



## Bird Nest swing seats



## Suspensions



Standard



Anti-wrap

## Deco-panels



EcoCore™ HDPE

## Chain options



- Stainless steel
- Hot-dip galvanised

## Create swing set with immediate visualizations

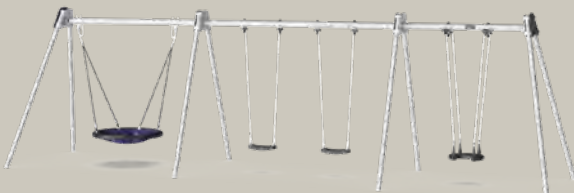

## Create swing sets with instant visualisations



Steel

## Posts



Impregnated pine wood



Hot-dip galvanized steel



TexMade™

TexMade™ posts for the lowest possible carbon emissions factor are available for all versions of the play system.

## More flexibility

Contact us for more information on the wide range of options for configurable playground equipment. Please note that prices and delivery terms depend on specified configurations.







# COROCORD™ ROPE PLAYGROUNDS





# COROCORD™ SKY PLAY

## Reach for the Stars

A Sky Play structure is an entire playground in one play system. At the top of the structure, the adventurous sky cabins await. The route to the sky cabin goes through an imposing climbing net where children can climb to safety and experience a sense of achievement.

Unleash your inner explorer and embark on a journey that'll have you reaching for the stars – literally!



### For a greener future

Post-consumer recycled materials:

Hercules Rope Yarn

>95%

Steel parts adhere to industrial standards



Tree Top Walk  
COR10470

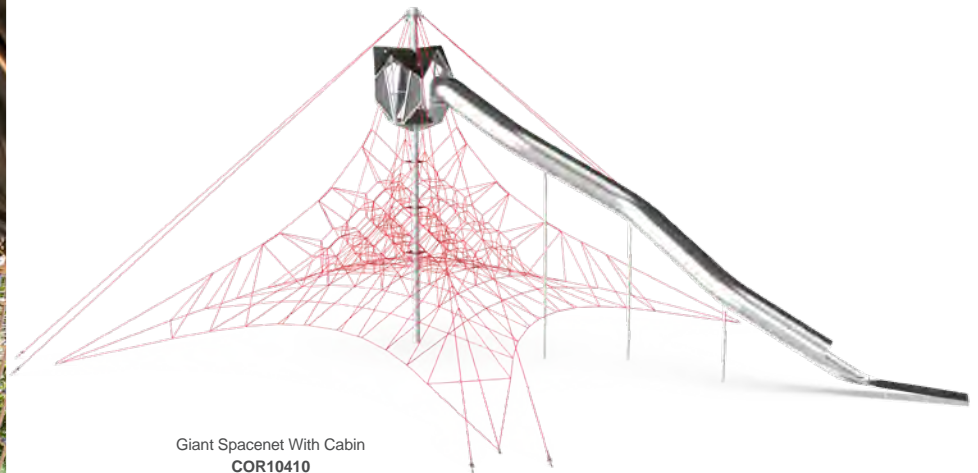

Giant Spacenet With Cabin  
COR10410

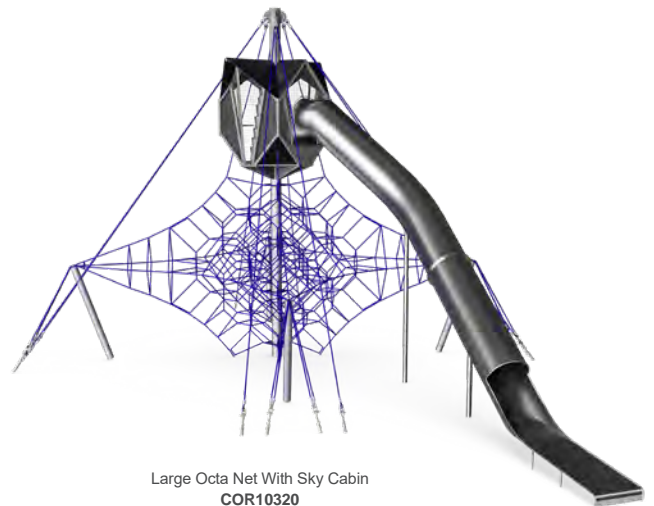

Large Octa Net With Sky Cabin  
COR10320

## PRODUCT INFORMATION

Product number	Product name	Age (years)	Capacity (users)	Fall height (ft & in)	Total height (ft & in)	Use zone dimensions (ft²)	Use zone dimensions (ft & in x ft & in)	Installation (hours)	Total CO <sub>2</sub> e (kg CO <sub>2</sub> e)
COR10470	Tree Top Walk	5 - 12	25	9'10"	27'6"	1545	58'10" x 59'10"	114	14,197
COR10410	Giant Spacenet With Cabin	5 - 12	108	8'6"	32'8"	3798	96'4" x 72'9"	92	11,516
COR10320	Large Octa Net With Sky Cabin	5 - 12	41	7'5"	23'11"	1683	60'1" x 42'10"	50	8,807





Products marked with “KDS” are tailor-made KOMPAN Design Studio solutions. Final designs and data depend on regional safety standards, and pictures are for conceptual purpose only.



## PRODUCT INFORMATION

Product number	Product name	Age (years)	Capacity (users)	Fall height (ft & in)	Total height (ft & in)	Use zone dimensions (ft <sup>2</sup> )	Use zone dimensions (ft & in x ft & in)	Installation (hours)	Total CO <sub>2</sub> e (kg CO <sub>2</sub> e)
COR10330	Sky Walk	5 - 12	110	8'6"	29'10"	3651	90'7" x 89'12"	229	-



# COROCORD™ PLAY TOWERS

## Play Your Way to the Top

Corocord Play Towers offer a variety of ways to get to the top. Each level offers a new and colorful world of play where children can pave their way in a manner suitable for their age and abilities. The net structures challenge the children's cross-coordination skills and physical strength.

Moving upward, new climbing challenges arise and boost confidence. Talk about an elevated experience!

AVAILABLE  
IN ONE, TWO,  
OR THREE  
STORIES



Large Rope Play Tower  
COR29600



**For a greener future**  
Post-consumer recycled materials:  
Hercules Rope Yarn >95%  
Steel parts adhere to industrial standards

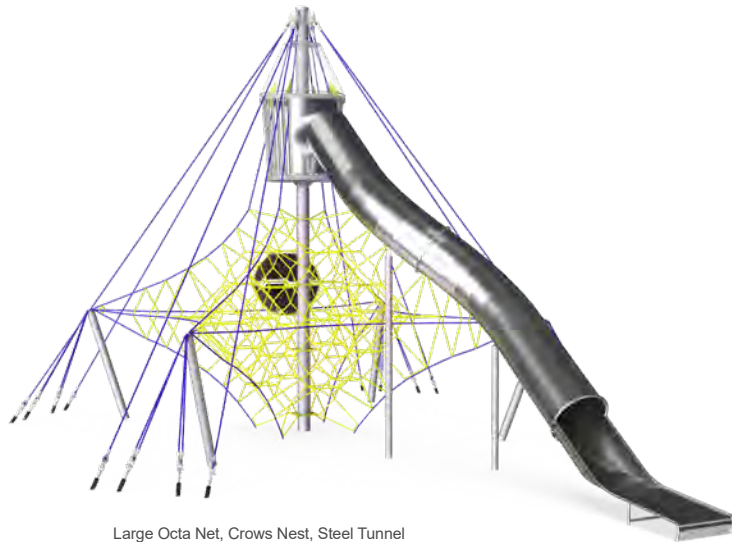

Large Octa Net, Crows Nest, Steel Tunnel  
COR10430



Jellyfish  
COR294002

### PRODUCT INFORMATION

Product number	Product name	Age (years)	Capacity (users)	Fall height (ft & in)	Total height (ft & in)	Use zone dimensions (ft <sup>2</sup> )	Use zone dimensions (ft & in x ft & in)	Installation (hours)	Total CO <sub>2</sub> e (kg CO <sub>2</sub> e)
COR29600	Large Rope Play Tower	5 - 12	33	4'11"	23'11"	967	42'5" x 41'10"	51	7,518
COR10430	Large Octa Net, Crows Nest, Steel Tunnel	5 - 12	41	7'5"	23'11"	1597	59'1" x 42'10"	86	7,624
COR294002	Jellyfish	5 - 12	18	8'0"	14'7"	750	34'6" x 25'7"	69	2,544





Triple Cube  
COR10450



Quad Cube  
COR10460

## PRODUCT INFORMATION

Product number	Product name	Age (years)	Capacity (users)	Fall height (ft & in)	Total height (ft & in)	Use zone dimensions (ft²)	Use zone dimensions (ft & in x ft & in)	Installation (hours)	Total CO <sub>2</sub> e (kg CO <sub>2</sub> e)
COR10450	Triple Cube	5 - 12	30	5'3"	22'11"	583	32'11" x 22'6"	137	14,134
COR10460	Quad Cube	5 - 12	45	3'7"	30'3"	1041	31'11" x 61'11"	229	21,189



# COROCORD™ PLAY TOWERS



SkyTwister, Physical  
COR29900



SkyTwister, Sensory  
COR29910

## PRODUCT INFORMATION

Product number	Product name	Age (years)	Capacity (users)	Fall height (ft & in)	Total height (ft & in)	Use zone dimensions (ft²)	Use zone dimensions (ft & in x ft & in)	Installation (hours)	Total CO <sub>2</sub> e (kg CO <sub>2</sub> e)
COR29900	SkyTwister, Physical	5 - 12	30	8'0"	16'6"	718	30'5" x 40'11"	35	4,367
COR29910	SkyTwister, Sensory	5 - 12	36	8'0"	16'6"	866	33'4" x 43'1"	39	6,258





Surfer, Hangout  
COR29950



Surfer, Optic  
COR29960

## PRODUCT INFORMATION

Product number	Product name	Age (years)	Capacity (users)	Fall height (ft & in)	Total height (ft & in)	Use zone dimensions (ft²)	Use zone dimensions (ft & in x ft & in)	Installation (hours)	Total CO <sub>2</sub> e (kg CO <sub>2</sub> e)
COR29950	Surfer, Hangout	5 - 12	4	1'1"	8'1"	380	25'7" x 18'3"	6.6	889
COR29960	Surfer, Optic	5 - 12	6	0'0"	8'3"	-	0'0" x 0'0"	6.5	997



# COROCORD™ LOOPS

## Social Seating and Togetherness

Loop sculptures draw everyone's attention with their fascinating shapes and bright colors. These eye-catchers hold multiple loop play activities. While children slide, climb, balance, crawl, jump, or dangle, they practice essential skills in child development.

Corocord Loop structures are here to make playtime extraordinary, one thrilling adventure at a time!

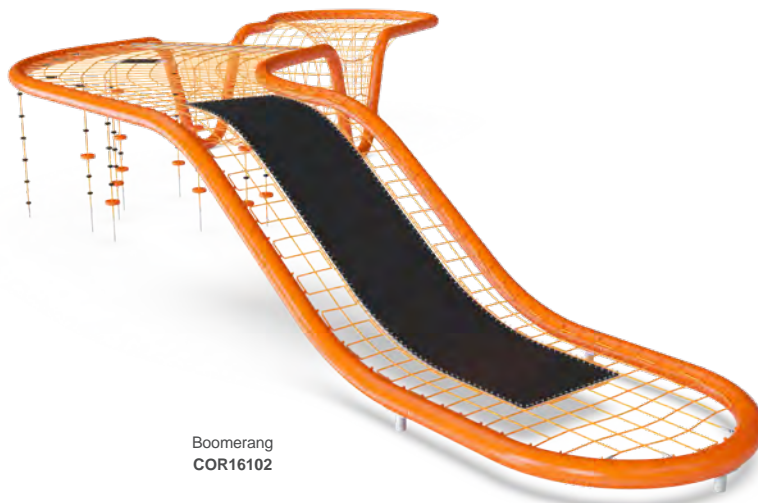

Boomerang  
COR16102



**For a greener future**  
Post-consumer recycled materials:  
Hercules Rope Yarn >95%  
Steel parts adhere to industrial standards

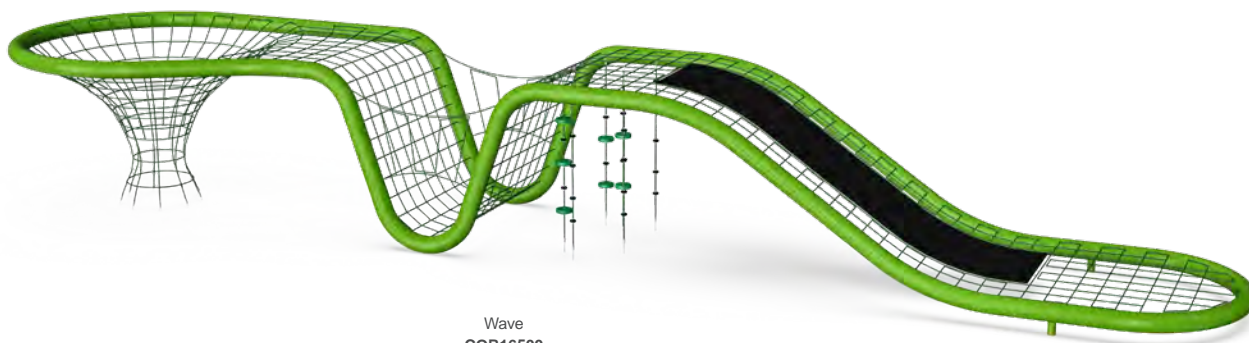

Wave  
COR16500



## PRODUCT INFORMATION

Product number	Product name	Age (years)	Capacity (users)	Fall height (ft & in)	Total height (ft & in)	Use zone dimensions (ft²)	Use zone dimensions (ft & in x ft & in)	Installation (hours)	Total CO <sub>2</sub> e (kg CO <sub>2</sub> e)
COR16102	Boomerang	5 - 12	64	9'3"	9'3"	2390	83'4" x 58'9"	122	16,731
COR16500	Wave	5 - 12	55	9'2"	9'2"	1692	76'7" x 26'11"	103	18,179





Super Frisbee  
COR17100

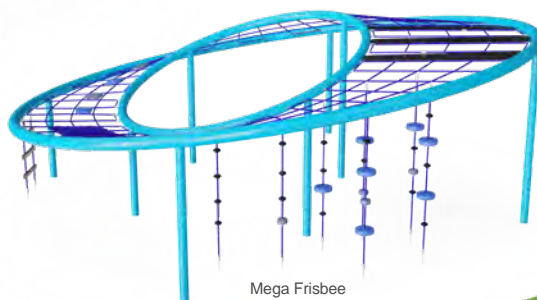

Mega Frisbee  
COR17200

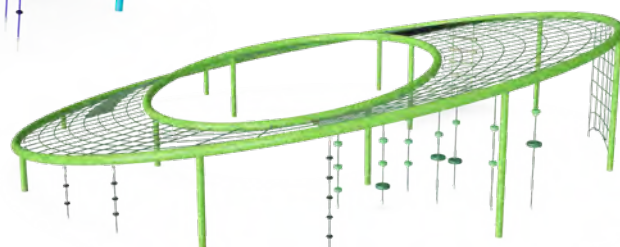

Giga Frisbee  
COR17300

## PRODUCT INFORMATION

Product number	Product name	Age (years)	Capacity (users)	Fall height (ft & in)	Total height (ft & in)	Use zone dimensions (ft <sup>2</sup> )	Use zone dimensions (ft & in x ft & in)	Installation (hours)	Total CO <sub>2</sub> e (kg CO <sub>2</sub> e)
COR17100	Super Frisbee	5 - 12	30	6'11"	6'11"	817	32'2" x 32'4"	23	3,577
COR17200	Mega Frisbee	5 - 12	104	9'4"	9'4"	1179	38'7" x 38'11"	26	5,497
COR17300	Giga Frisbee	5 - 12	117	9'2"	9'2"	2097	51'3" x 52'0"	45	9,138



# COROCORD™ LOOPS



Butterfly, Physical  
COR17510



Butterfly, Social  
COR17520



Butterfly, Sensory  
COR17530



## PRODUCT INFORMATION

Product number	Product name	Age (years)	Capacity (users)	Fall height (ft & in)	Total height (ft & in)	Use zone dimensions (ft <sup>2</sup> )	Use zone dimensions (ft & in x ft & in)	Installation (hours)	Total CO <sub>2</sub> e (kg CO <sub>2</sub> e)
COR17510	Butterfly, Physical	5 - 12	22	9'10"	10'1"	715	34'7" x 30'9"	22	2,938
COR17520	Butterfly, Social	5 - 12	22	9'10"	10'1"	675	34'6" x 26'10"	22	2,992
COR17530	Butterfly, Sensory	5 - 12	24	9'10"	10'1"	667	34'8" x 25'11"	21	2,924



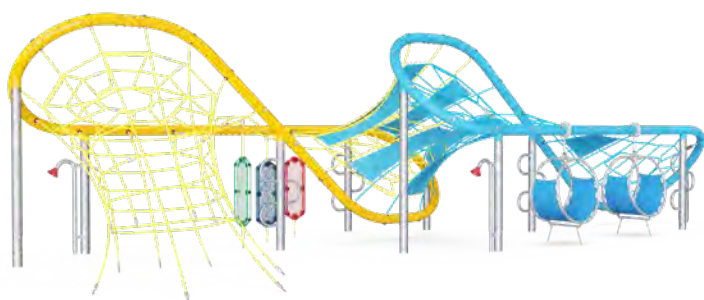

Butterfly, Double  
COR17600



Butterfly, Triple  
COR17700

## PRODUCT INFORMATION

Product number	Product name	Age (years)	Capacity (users)	Fall height (ft & in)	Total height (ft & in)	Use zone dimensions (ft <sup>2</sup> )	Use zone dimensions (ft & in x ft & in)	Installation (hours)	Total CO <sub>2</sub> e (kg CO <sub>2</sub> e)
COR17600	Butterfly, Double	5 - 12	34	9'10"	10'1"	1018	49'3" x 26'1"	43	6,095
COR17700	Butterfly, Triple	5 - 12	50	9'10"	10'1"	1345	42'4" x 38'5"	62	8,932



# FLEXIBILITY

With a variety of colors and part options, we offer lots of flexibility and customization with our standard products.



Rope colors

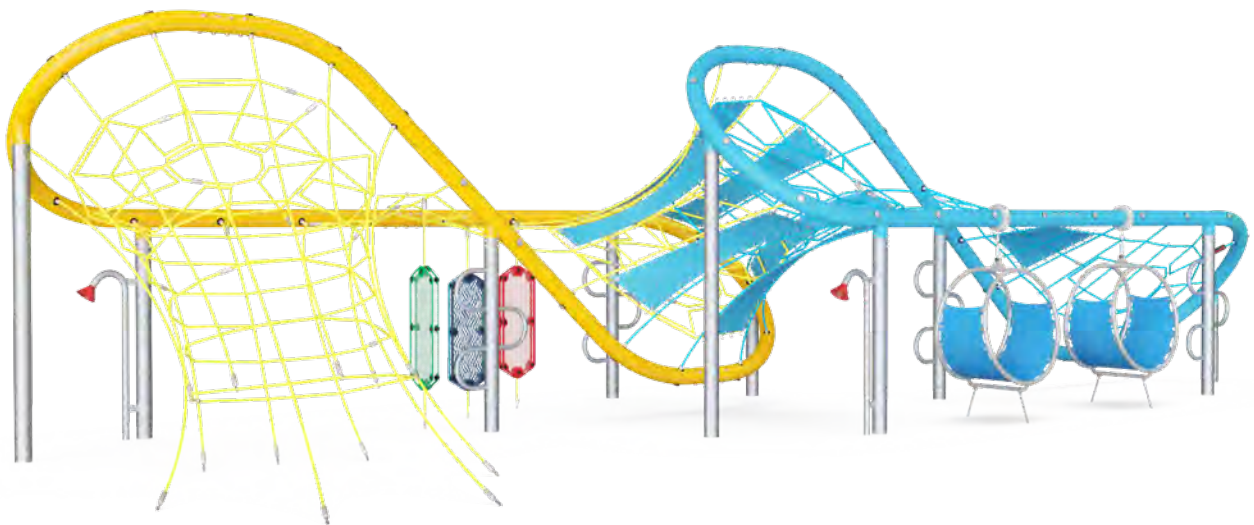

Loop colors







Graphic or dichromatic panels

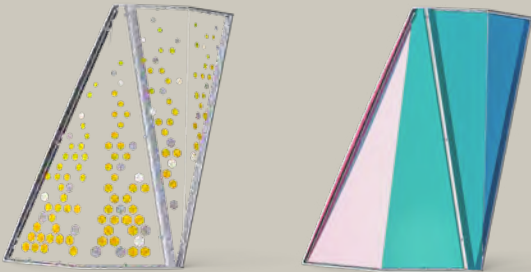

Talk tubes



Sensory and creative activities

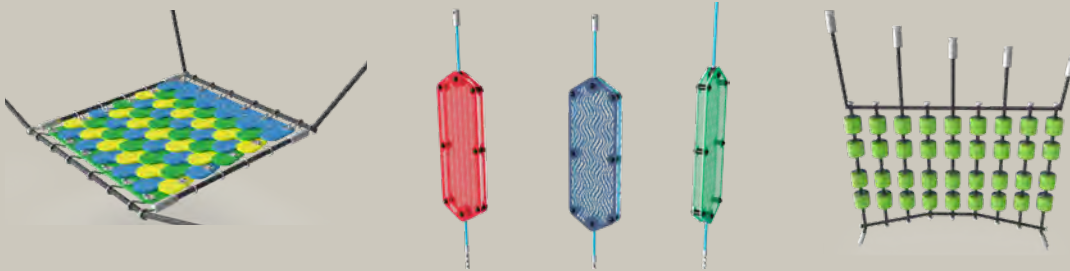

Climbing and hang-out activities

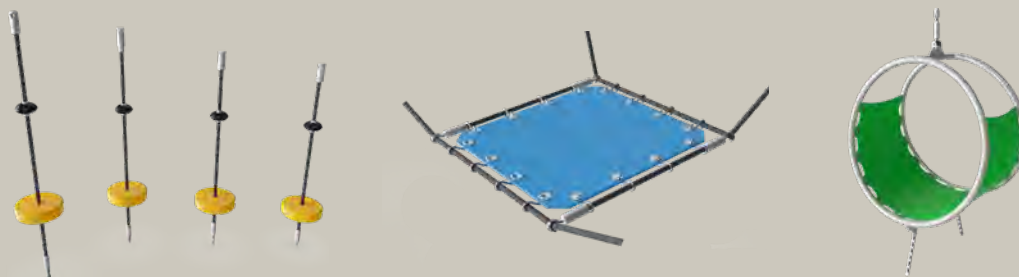

Slides in PE or stainless steel

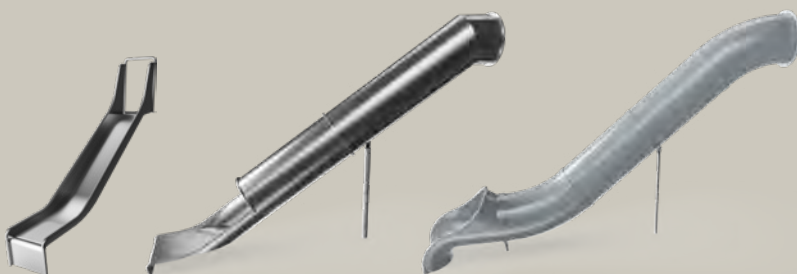

Anti-climb panels



NOTE:  
Steel slides heated by the midday sun can cause severe skin burns. We recommend pointing steel slides away from the midday sun or using PE slides or shading.

## More flexibility

Contact us for more information on the wide range of options for configurable playground equipment. Please note that prices and delivery terms depend on specified configurations.



# COROCORD™ DYNAMICS

## Furniture for Indoor and Outdoor Use

Rotating, swinging, and bouncing fun – hardly any child can resist the magnetic attraction of these dynamic products. The play structures deliver high-quality fun, drawing on the fundamental gravitational forces, while powerful movement experiences help the child's nervous system mature and organize.

Let the gravitational forces take you for a spin and enjoy a thrilling ride while giggles echo for miles.



### For a greener future

Post-consumer recycled materials:

Hercules Rope Yarn

>95%

Steel parts adhere to industrial standards



Mini Twister  
COR20310



Inclusive Twister  
COR20330



Cone Twister  
COR20320



Net Twister  
COR20301



Rhombus Twister  
COR20340



## PRODUCT INFORMATION

Product number	Product name	Age (years)	Capacity (users)	Fall height (ft & in)	Total height (ft & in)	Use zone dimensions (ft <sup>2</sup> )	Use zone dimensions (ft & in x ft & in)	Installation (hours)	Total CO <sub>2</sub> e (kg CO <sub>2</sub> e)
COR20310	Mini Twister	5 - 12	7	4'1"	7'5"	383	22'1" x 22'1"	5.3	540
COR20330	Inclusive Twister	5 - 12	12	7'4"	7'5"	437	23'7" x 23'7"	5.6	681
COR20320	Cone Twister	5 - 12	9	4'11"	7'0"	437	23'7" x 23'7"	4.1	544
COR20301	Net Twister	5 - 12	10	9'2"	9'2"	573	27'0" x 27'0"	4.5	678
COR20340	Rhombus Twister	5 - 12	10	8'0"	9'6"	437	23'7" x 23'7"	5.6	699



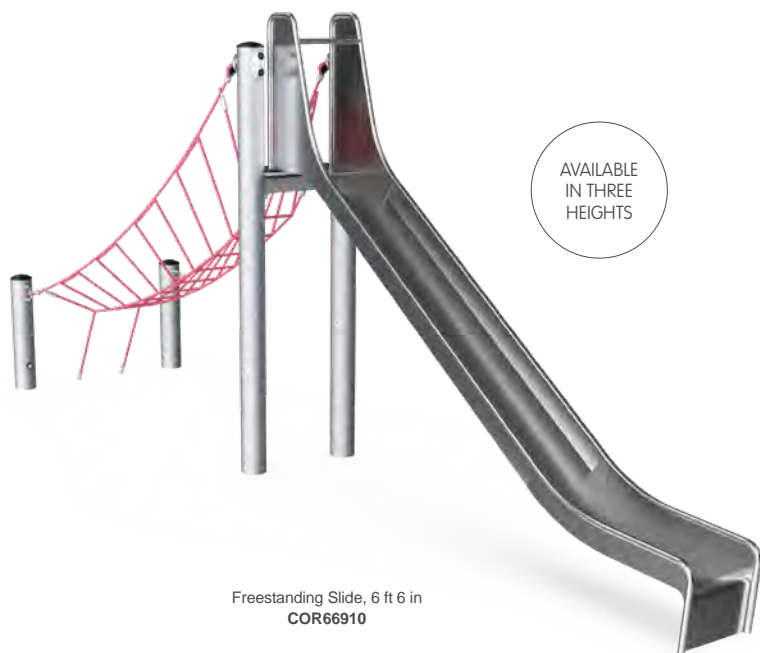

AVAILABLE  
IN THREE  
HEIGHTS

Freestanding Slide, 6 ft 6 in  
**COR66910**



Hexagonal Jumping Net  
**COR21506**

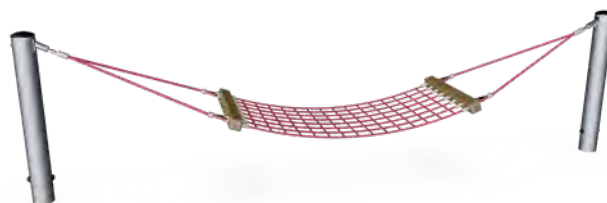

Rope Hammock  
**COR20502**



Jumping Bridge  
**COR68060**



Membrane Hammock  
**COR20402**

**PRODUCT INFORMATION**

NOTE: Steel slides heated by the midday sun can cause severe skin burns. We recommend pointing steel slides away from the midday sun or using PE slides or shading.

Product number	Product name	Age (years)	Capacity (users)	Fall height (ft & in)	Total height (ft & in)	Use zone dimensions (ft <sup>2</sup> )	Use zone dimensions (ft & in x ft & in)	Installation (hours)	Total CO <sub>2</sub> e (kg CO <sub>2</sub> e)
<b>COR66900</b>	Freestanding Slide, 5 ft	5 - 12	4	4'11"	8'2"	452	31'10" x 17'2"	8.5	986
<b>COR66910</b>	Freestanding Slide, 6 ft 6 in	5 - 12	4	6'7"	9'9"	505	35'1" x 17'9"	9.3	1,102
<b>COR66920</b>	Freestanding Slide, 8 ft	5 - 12	4	8'2"	10'6"	521	38'1" x 17'1"	9.5	1,170
<b>COR21506</b>	Hexagonal Jumping Net	5 - 12	6	2'4"	2'4"	701	29'10" x 29'10"	6	748
<b>COR20502</b>	Rope Hammock	2 - 12	4	4'3"	4'7"	372	29'6" x 15'2"	3.5	347
<b>COR68060</b>	Jumping Bridge	5 - 12	12	2'9"	6'5"	481	33'4" x 15'11"	6	994
<b>COR20402</b>	Membrane Hammock	2 - 12	4	4'7"	4'8"	372	29'6" x 15'2"	3.2	419



# COROCORD™ SLIDES & HILL CLIMBER ROPES

## Slide, Climb, Repeat

Enjoy the fun of an embankment slide as you share the thrills with your friends, zooming down the same hill and climbing back up over and over again. Hill Climbers perfectly supplement embankment slides: available in different lengths, you can find the perfect fit for your hill slopes, whether a gentle 20° or a more daring 60°.

Start cheering and let the sliding, climbing fun, and belly-laughing begin!



**For a greener future**  
 Post-consumer recycled materials:  
 Hercules Rope Yarn >95%  
 Steel parts adhere to industrial standards



Embankment Tunnel Slide, 7 ft  
**COR71005**



Embankment Slide, 1 ft 8 in wide  
**COR71050**



Embankment Slide, 3 ft in wide  
**COR71100**



Embankment Slide Extra wide, 5 ft in wide  
**COR71150**



Embankment Slide Extra wide, 6 ft 7 in wide  
**COR71200**

### PRODUCT INFORMATION

NOTE: Steel slides heated by the midday sun can cause severe skin burns. We recommend pointing steel slides away from the midday sun or using PE slides or shading.

Product number	Product name	Age (years)	Capacity (users)	Fall height (ft & in)	Total height (ft & in)	Use zone dimensions (ft <sup>2</sup> )	Use zone dimensions (ft & in x ft & in)	Installation (hours)	Total CO <sub>2</sub> e (kg CO <sub>2</sub> e)
<b>COR71005</b>	Embankment Tunnel Slide, 7 ft	2 - 12	2	3'4"	2'7"	146	20'10" x 14'9"	6.8	1,414
<b>COR71050</b>	Embankment Slide, 1 ft 8 in wide	2 - 12	2	3'4"	3'2"	115	18'5" x 13'8"	5.7	338
<b>COR71100</b>	Embankment Slide, 3 ft in wide	2 - 12	2	3'4"	3'2"	136	18'6" x 15'3"	5.7	842
<b>COR71150</b>	Embankment Slide Extra wide, 5 ft in wide	2 - 12	2	3'4"	3'2"	153	18'5" x 17'1"	5.7	968
<b>COR71200</b>	Embankment Slide Extra wide, 6 ft 7 in wide	2 - 12	2	3'4"	3'2"	168	18'5" x 18'8"	5.7	1,262





Hill Climber Rope with EPDM  
COR10545

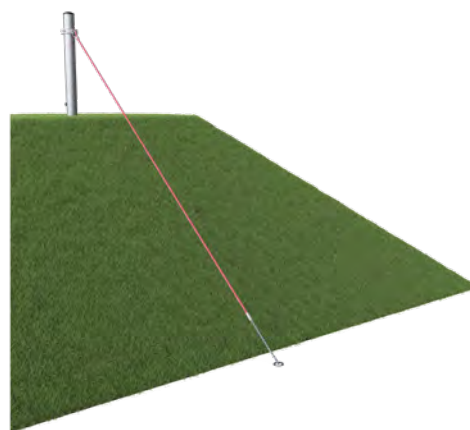

Hill Climber  
COR10535



## PRODUCT INFORMATION

Product number	Product name	Age (years)	Capacity (users)	Fall height (ft & in)	Total height (ft & in)	Use zone dimensions (ft²)	Use zone dimensions (ft & in x ft & in)	Installation (hours)	Total CO <sub>2</sub> e (kg CO <sub>2</sub> e)
COR10545	Hill Climber Rope with EPDM	2 - 12	2	0'0"	12'1"	-	0'0" x 0'0"	2.3	152
COR10535	Hill Climber	2 - 12	2	0'0"	12'1"	-	0'0" x 0'0"	2.2	140



# COROCORD™ MINI DOMES

PRODUCT CONFIGURATOR  
www.kompan.com



## Crawl and Climb for the Little Ones

This Mini Dome is a wondrous climb-and-crawl structure for little explorers. With inviting resting points for socializing, gently bouncing climbs, and intriguing play panels, this small structure is big on play value for 2-to-5-year-olds.

Children can crawl to the top or play peekaboo at ground level beneath the structure. The abacus and mirror play panel ensure hours of exploration and play.



### For a greener future

#### Post-consumer recycled materials:

Hollow Plastic Parts  
Hercules Rope Yarn

33%  
>95%

Steel parts adhere to industrial standards



Mini Dome  
CRP810101



Mini Dome with Slide  
CRP810201

## PRODUCT INFORMATION

Product number	Product name	Age (years)	Capacity (users)	Fall height (ft & in)	Total height (ft & in)	Use zone dimensions (ft²)	Use zone dimensions (ft & in x ft & in)	Installation (hours)	Total CO <sub>2</sub> e (kg CO <sub>2</sub> e)
CRP810101	Mini Dome	2 - 5	32	4'2"	8'4"	686	34'10" x 29'10"	23	1,567
CRP810201	Mini Dome with Slide	2 - 5	42	4'2"	8'4"	921	36'11" x 36'6"	37	2,332





If you want a uniquely designed landmark playground, our KOMPAN Design Studio can help make your special place come true.

For example, see the Mini Dome below, uniquely designed by KOMPAN Design Studio.

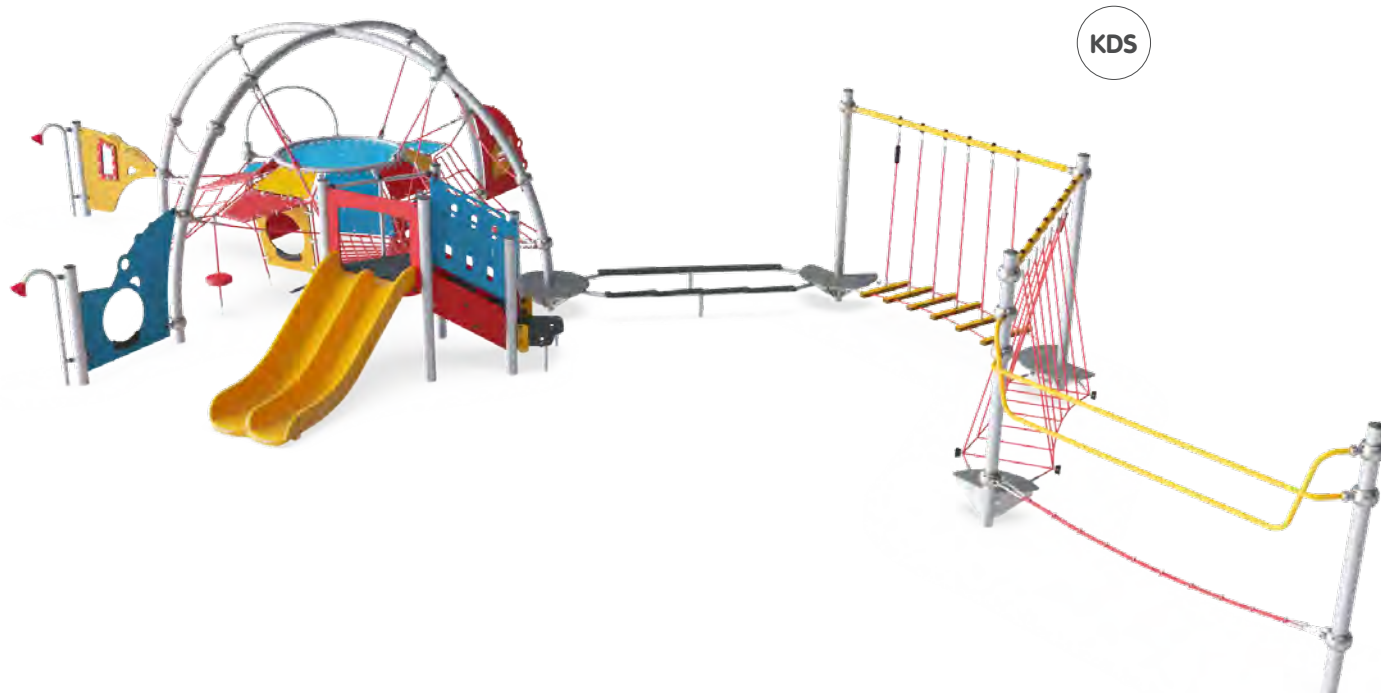



# COROCORD™ DOMES & ARCHES

## Lots of Wow and Play!

Corocord Domes are beautiful landmarks and WOW solutions that offer attraction, exploration, and challenging play activities – perfectly tailored to captivate the 6-to-12-year-olds. Physical, cognitive, and social challenges are all contained within one grand framework.

Lots of thrilling play packed into a compact space proves that big fun can come in small footprints.

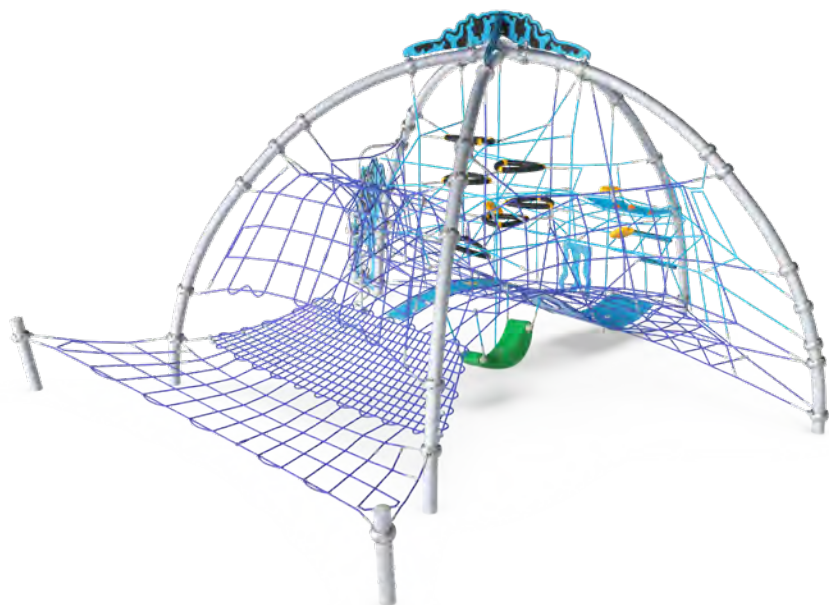

Ocean Dome  
CRP811501



### For a greener future

#### Post-consumer recycled materials:

Hollow Plastic Parts  
Hercules Rope Yarn

33%  
>95%

Steel parts adhere to industrial standards

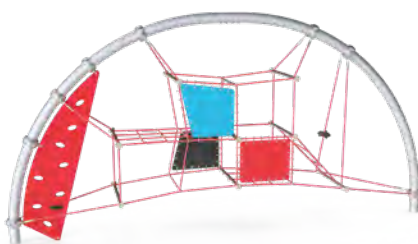

Performer Arch  
CRP800101



Explorer Arch  
CRP800501

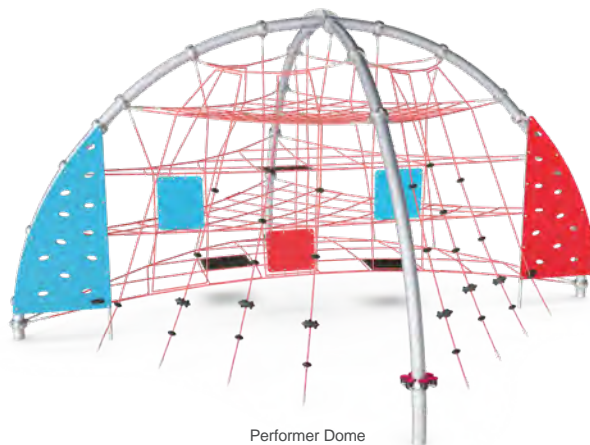

Performer Dome  
CRP811001

## PRODUCT INFORMATION

Product number	Product name	Age (years)	Capacity (users)	Fall height (ft & in)	Total height (ft & in)	Use zone dimensions (ft <sup>2</sup> )	Use zone dimensions (ft & in x ft & in)	Installation (hours)	Total CO <sub>2</sub> e (kg CO <sub>2</sub> e)
CRP811501	Ocean Dome	5 - 12	58	9'10"	14'9"	1185	41'3" x 41'2"	93	5,035
CRP800101	Performer Arch	5 - 12	15	7'5"	10'1"	426	32'5" x 16'8"	23	1,250
CRP800501	Explorer Arch	5 - 12	12	7'5"	10'2"	418	32'2" x 16'8"	24	1,143
CRP811001	Performer Dome	5 - 12	52	9'10"	13'8"	946	38'11" x 39'3"	54	3,413





Explorer Dome  
CRP812501

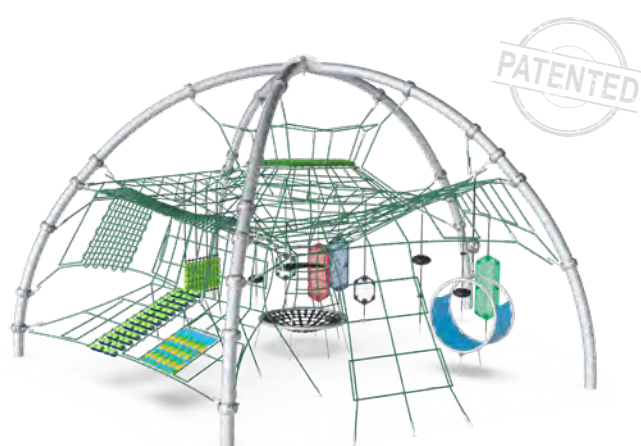

Sensory Dome  
CRP812001

## PRODUCT INFORMATION

Product number	Product name	Age (years)	Capacity (users)	Fall height (ft & in)	Total height (ft & in)	Use zone dimensions (ft²)	Use zone dimensions (ft & in x ft & in)	Installation (hours)	Total CO <sub>2</sub> e (kg CO <sub>2</sub> e)
CRP812501	Explorer Dome	5 - 12	52	9'10"	13'7"	1095	38'11" x 35'5"	64	4,826
CRP812001	Sensory Dome	5 - 12	60	8'9"	13'9"	1027	37'6" x 36'3"	71	4,535



# FLEXIBILITY

With a variety of colors and part options, we offer lots of flexibility and customization with our standard products.



Green and Steel



Red



Green



Lime



Blue



Orange



Beige





## Rope colors

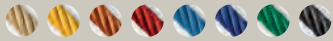

## Steel colors



## Interlinked Product Solutions

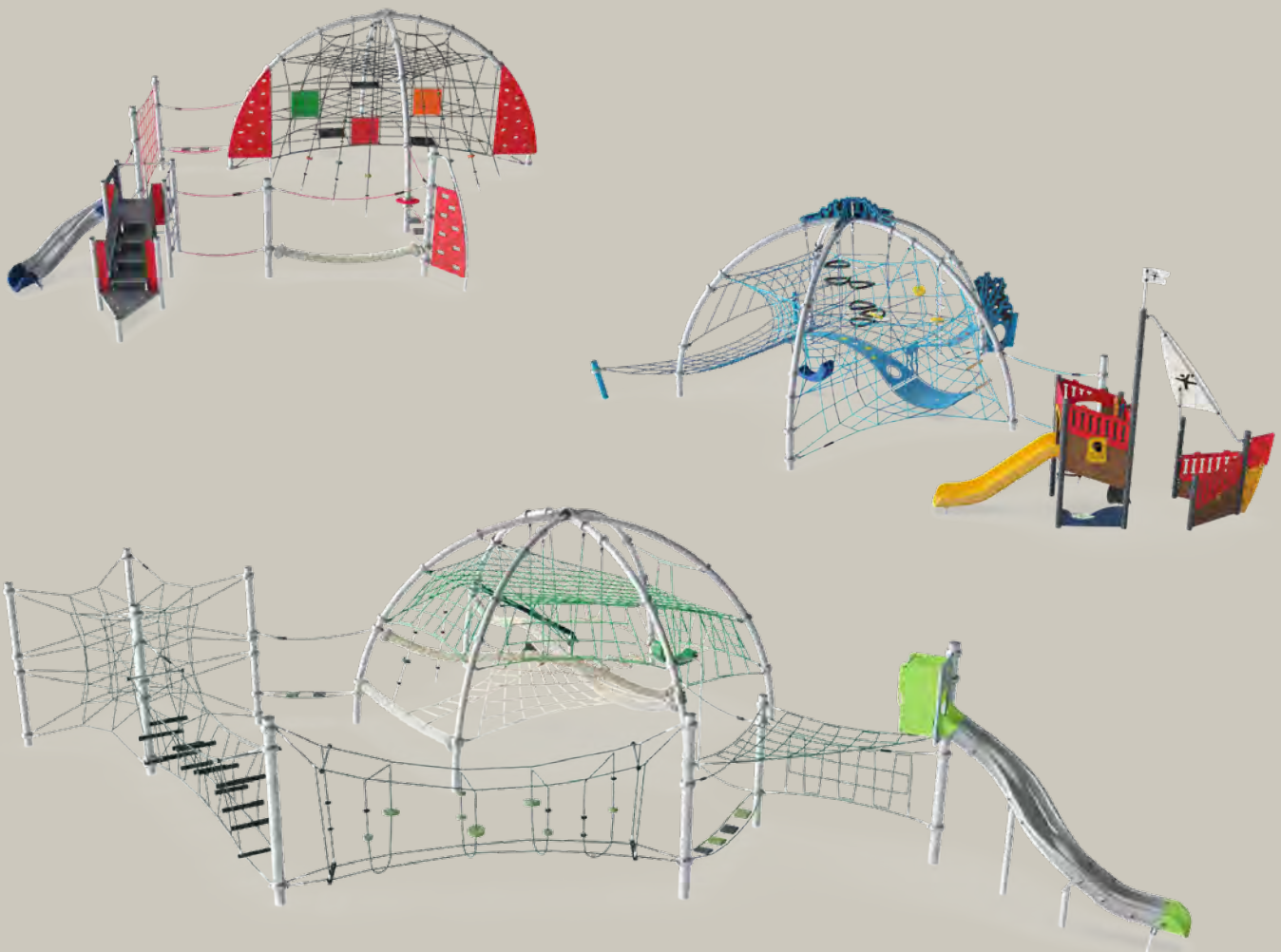

### More flexibility

Contact us for more information on the wide range of options for configurable playground equipment. Please note that prices and delivery terms depend on specified configurations.



# COROCORD™ DOMES & ARCHES

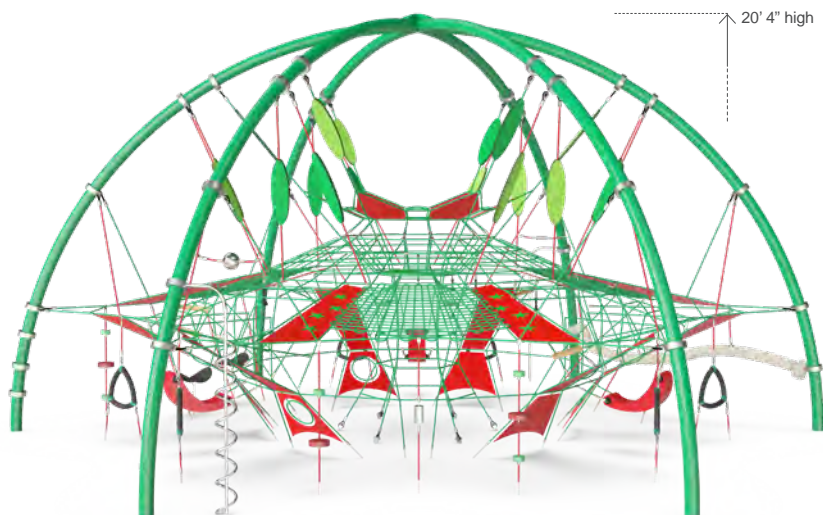

Giant Dome  
COR86700

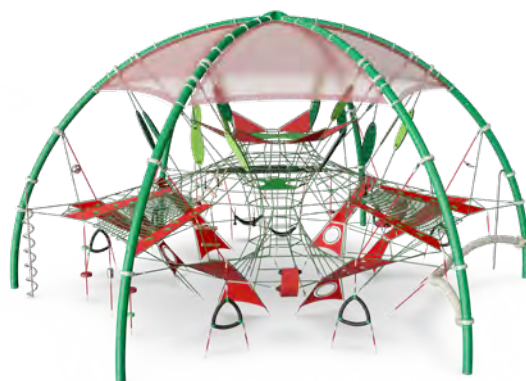

LUNA

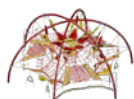

MARS

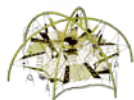

SOLARIS

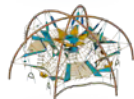

VENUS

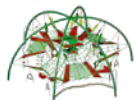

TERRA

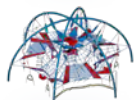

NEPTUNE



## PRODUCT INFORMATION

Product number	Product name	Age (years)	Capacity (users)	Fall height (ft & in)	Total height (ft & in)	Use zone dimensions (ft <sup>2</sup> )	Use zone dimensions (ft & in x ft & in)	Installation (hours)	Total CO <sub>2</sub> e (kg CO <sub>2</sub> e)
COR86700	Giant Dome	5 - 12	90	8'6"	20'4"	1647	51'11" x 47'1"	97	11,650
CRE86700	Sunshade for Giant Dome	5 - 12	-	0'0"	5'6"	-	0'0" x 0'0"	29	2,069



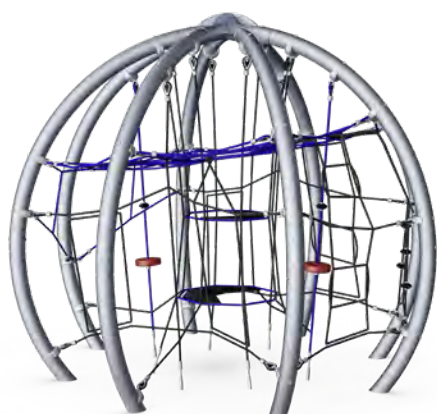

Climbing Sphere  
COR88100

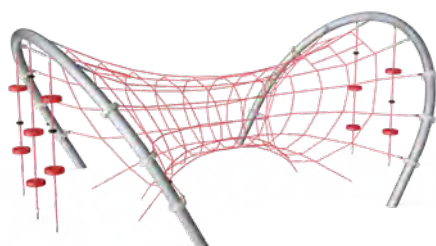

Arc Tunnel  
COR20600

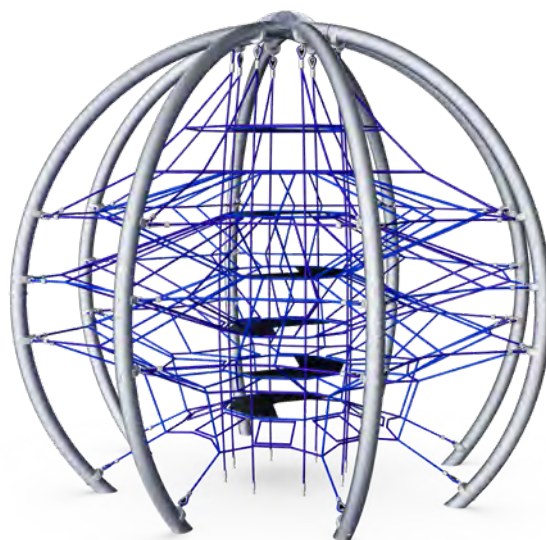

Crystal Sphere  
COR88200

## PRODUCT INFORMATION

Product number	Product name	Age (years)	Capacity (users)	Fall height (ft & in)	Total height (ft & in)	Use zone dimensions (ft <sup>2</sup> )	Use zone dimensions (ft & in x ft & in)	Installation (hours)	Total CO <sub>2</sub> e (kg CO <sub>2</sub> e)
COR88200	Crystal Sphere	5 - 12	51	8'4"	14'3"	633	28'5" x 28'5"	32	3,458
COR88100	Climbing Sphere	5 - 12	32	7'10"	10'10"	495	25'1" x 25'1"	27	2,896
COR20600	Arc Tunnel	5 - 12	17	8'2"	8'2"	688	31'4" x 25'7"	33	2,110



# COROCORD™ SPACENET™

## Three-Dimensional and Sky-High Play Activities

Very few play spaces incite children to move around in all directions as the Spacenet does. This sky-high playspace sparks their imagination as they venture into a thrilling three-dimensional universe. A Corocord Spacenet is superior for developing a child's cross-coordination and physical skills.

With a Spacenet, the horizon knows no limits, and the joy of exploration knows no bounds.



**For a greener future**  
**Post-consumer recycled materials:**  
 Hercules Rope Yarn >95%  
 Steel parts adhere to industrial standards

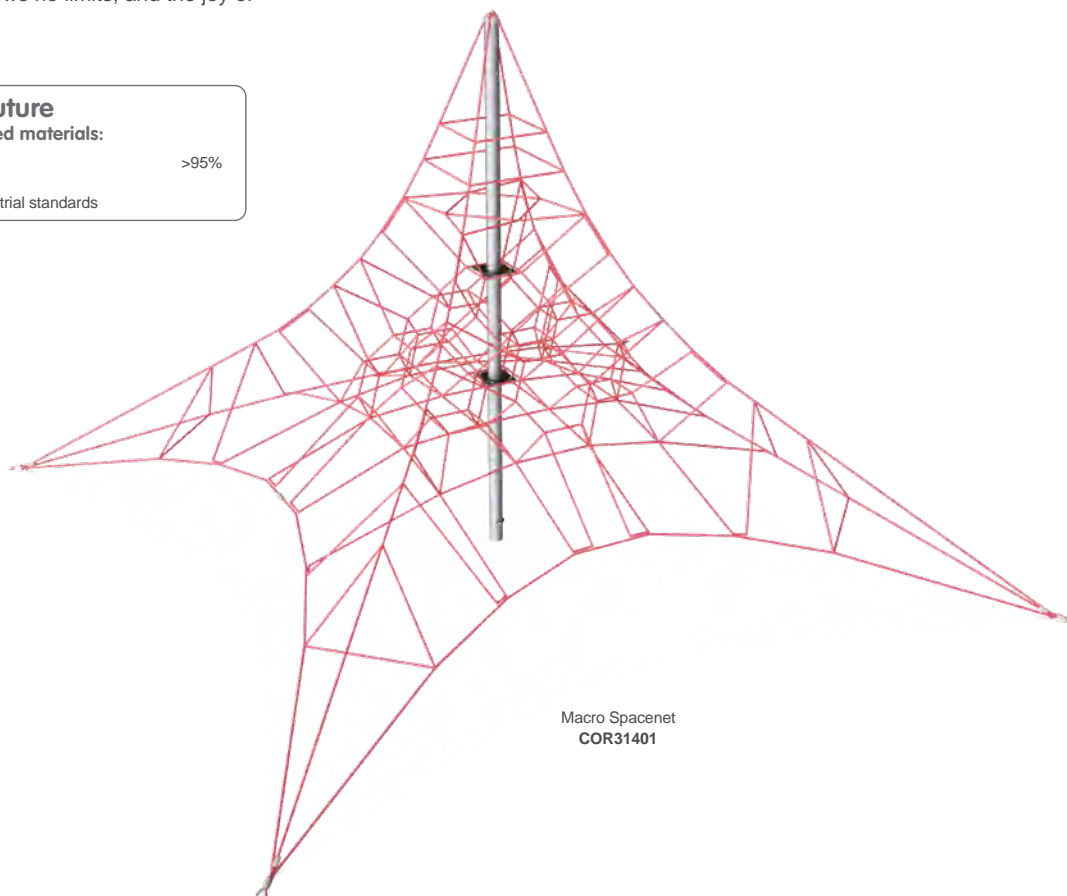

Macro Spacenet  
COR31401

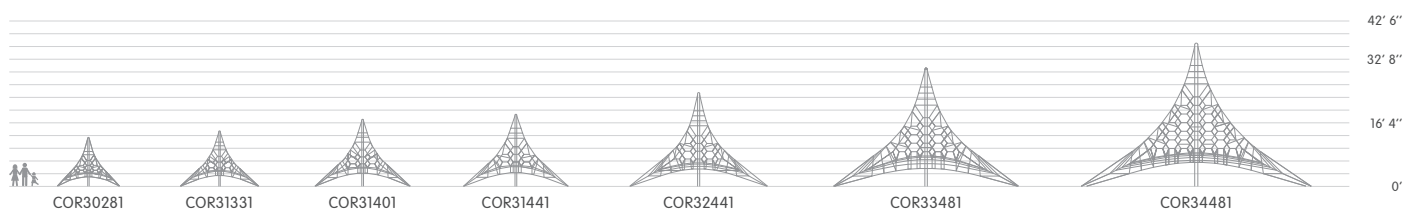

### PRODUCT INFORMATION

Product number	Product name	Age (years)	Capacity (users)	Fall height (ft & in)	Total height (ft & in)	Use zone dimensions (ft <sup>2</sup> )	Use zone dimensions (ft & in x ft & in)	Installation (hours)	Total CO <sub>2</sub> e (kg CO <sub>2</sub> e)
<b>COR31401</b>	Macro Spacenet	5 - 12	38	5'7"	17'7"	1166	38'9" x 38'9"	15	1,337
<b>COR30281</b>	Mini Spacenet	2 - 5	24	6'0"	12'11"	749	29'9" x 29'9"	11	994
<b>COR30301</b>	Mini Spacenet, Wide	2 - 5	25	6'0"	12'11"	868	32'6" x 32'6"	11	1,024
<b>COR31331</b>	Midi Spacenet	2 - 5	30	6'0"	14'10"	947	34'5" x 34'5"	12	1,072
<b>COR31441</b>	Small Spacenet	5 - 12	40	6'1"	19'4"	1348	41'10" x 41'10"	16	1,432
<b>COR32441</b>	Large Spacenet	5 - 12	56	7'1"	24'8"	1799	49'8" x 49'8"	23	2,281
<b>COR33481</b>	Giant Spacenet	5 - 12	103	8'6"	30'11"	2728	62'7" x 62'7"	26	3,704
<b>COR34481</b>	Super Spacenet 48	5 - 12	160	9'10"	36'11"	3524	75'2" x 75'2"	46	6,610



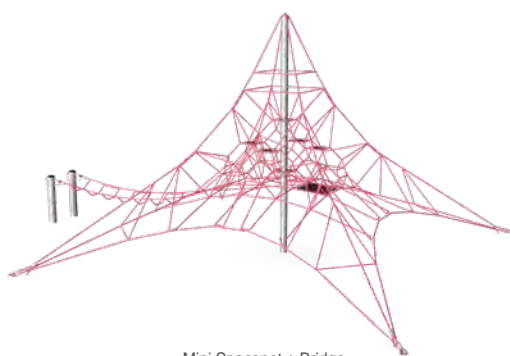

Mini Spacenet + Bridge  
COR101102

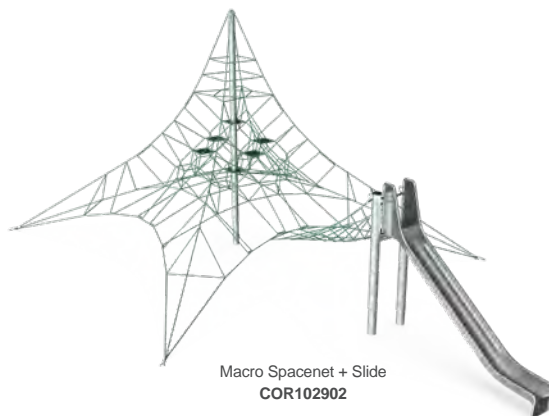

Macro Spacenet + Slide  
COR102902

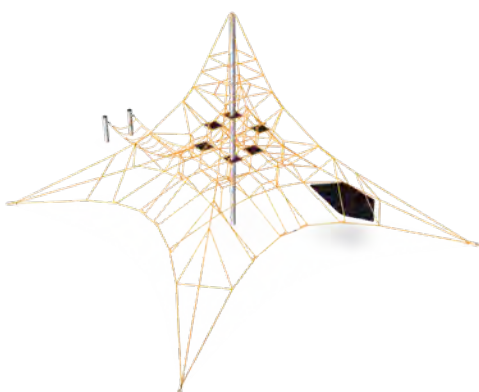

Small Spacenet + Bouncing Membrane  
COR101202

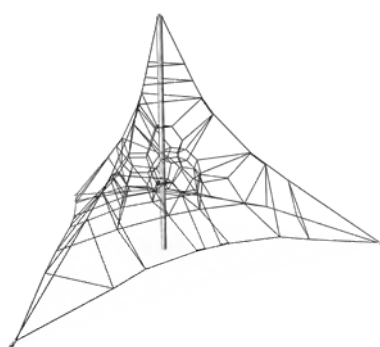

Triangular Spacenet  
COR37441

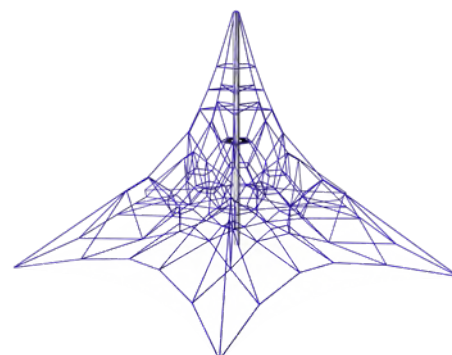

Pentagonal Spacenet  
COR35441

## PRODUCT INFORMATION

Product number	Product name	Age (years)	Capacity (users)	Fall height (ft & in)	Total height (ft & in)	Use zone dimensions (ft <sup>2</sup> )	Use zone dimensions (ft & in x ft & in)	Installation (hours)	Total CO <sub>2</sub> e (kg CO <sub>2</sub> e)
COR101102	Mini Spacenet + Bridge	2 - 5	14	3'11"	12'8"	974	38'5" x 32'6"	14	1,256
COR102902	Macro Spacenet + Slide	5 - 12	46	6'7"	17'7"	1437	55'3" x 38'9"	21	2,245
COR101202	Small Spacenet + Bouncing Membrane	5 - 12	24	6'1"	19'0"	1513	48'8" x 41'10"	19	1,758
COR37441	Triangular Spacenet	5 - 12	35	7'9"	19'0"	1119	45'9" x 41'4"	12	1,153
COR35441	Pentagonal Spacenet	5 - 12	45	6'0"	17'10"	1218	44'0" x 42'6"	17	1,542



# COROCORD™ SPACENET™

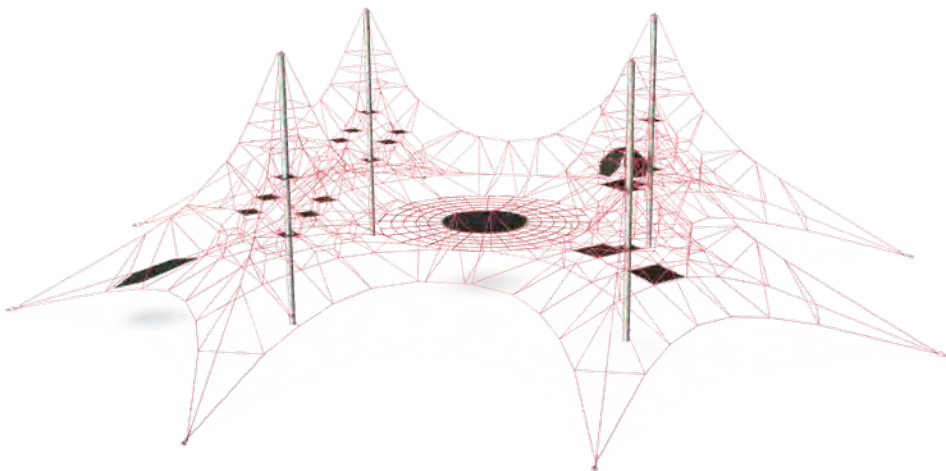

Four-Mast Spacenet + Bouncing Net  
COR104202

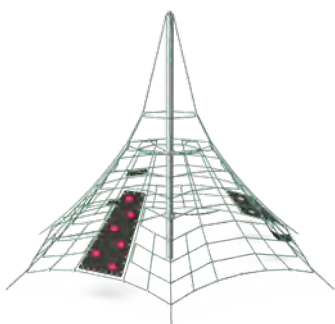

Emerald  
COR20700

AVAILABLE  
IN FOUR  
HEIGHTS

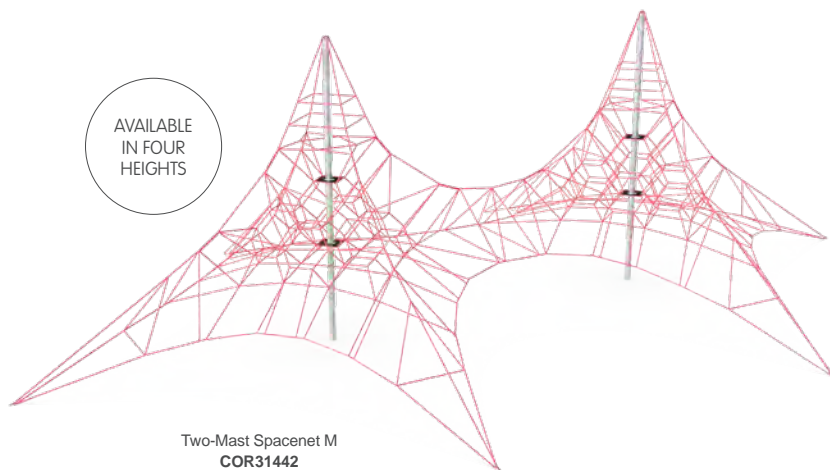

Two-Mast Spacenet M  
COR31442

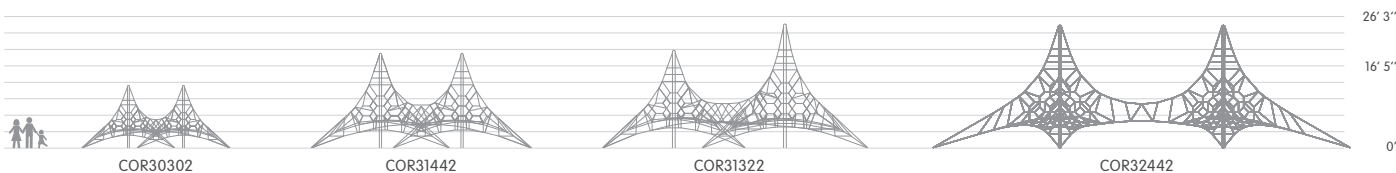

## PRODUCT INFORMATION

Product number	Product name	Age (years)	Capacity (users)	Fall height (ft & in)	Total height (ft & in)	Use zone dimensions (ft <sup>2</sup> )	Use zone dimensions (ft & in x ft & in)	Installation (hours)	Total CO <sub>2</sub> e (kg CO <sub>2</sub> e)
COR104202	Four-Mast Spacenet + Bouncing Net	5 - 12	178	6'0"	19'0"	3772	74'12" x 74'12"	55	5,254
COR20700	Emerald	5 - 12	38	6'7"	12'10"	684	30'10" x 28'4"	9	686
COR30302	Two-Mast Spacenet S	2 - 5	50	3'11"	12'12"	1424	56'10" x 40'5"	19	1,795
COR31442	Two-Mast Spacenet M	5 - 12	80	6'1"	19'4"	2278	77'6" x 53'7"	27	2,586
COR31322	Two-Mast Spacenet L	5 - 12	75	7'1"	24'8"	2678	88'3" x 60'5"	35	3,739
COR32442	Two-Mast Spacenet XL	5 - 12	112	7'1"	24'8"	3235	99'3" x 66'4"	38	4,227



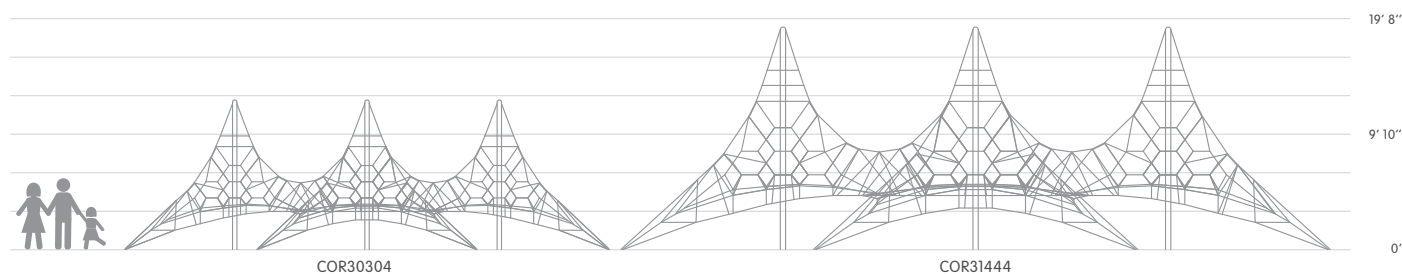
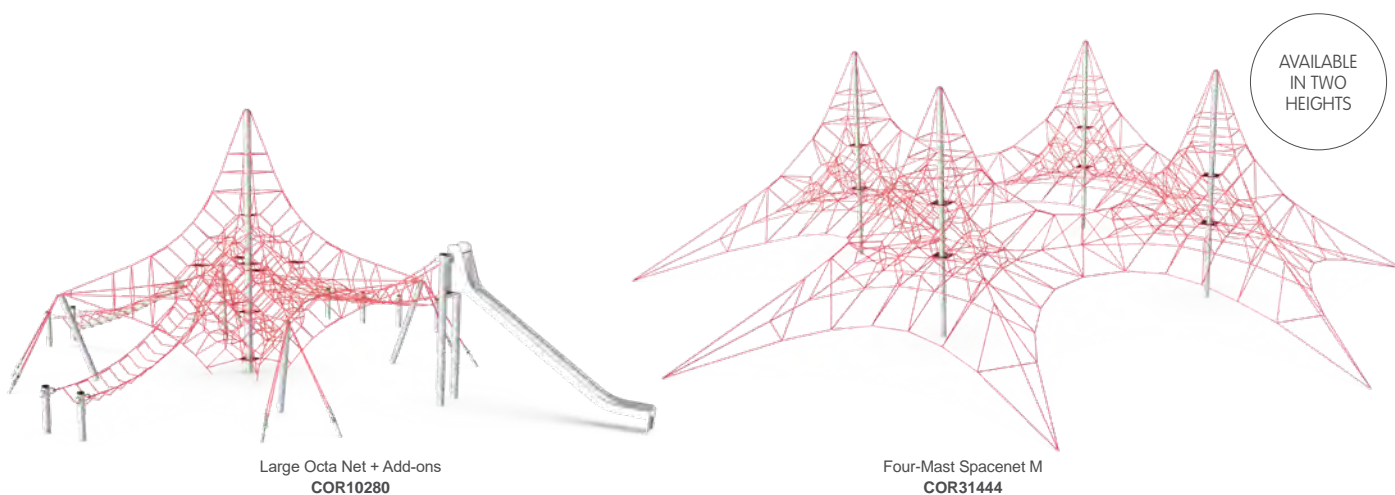

## PRODUCT INFORMATION

Product number	Product name	Age (years)	Capacity (users)	Fall height (ft & in)	Total height (ft & in)	Use zone dimensions (ft <sup>2</sup> )	Use zone dimensions (ft & in x ft & in)	Installation (hours)	Total CO <sub>2</sub> e (kg CO <sub>2</sub> e)
<b>COR10280</b>	Large Octa Net + Add-ons	5 - 12	75	7'10"	19'8"	1932	61'11" x 52'1"	39	4,869
<b>COR30304</b>	Four-Mast Spacenet S	2 - 5	100	3'11"	12'11"	2237	55'0" x 55'0"	31	3,078
<b>COR31444</b>	Four-Mast Spacenet M	5 - 12	160	6'1"	19'4"	3772	74'12" x 74'12"	47	4,630



# COROCORD™ SPACENET™

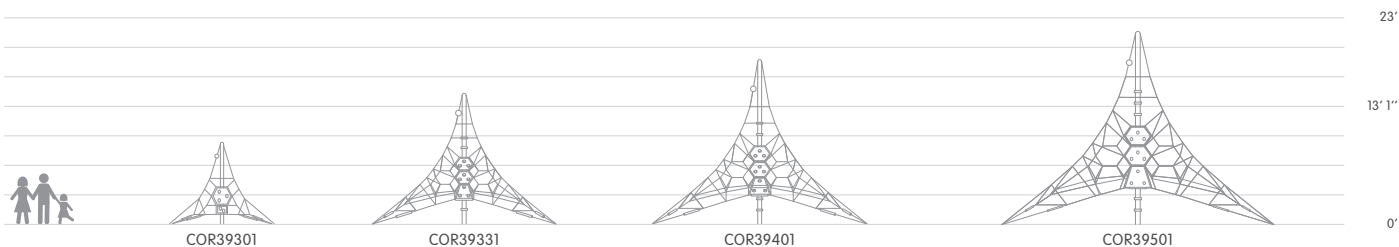
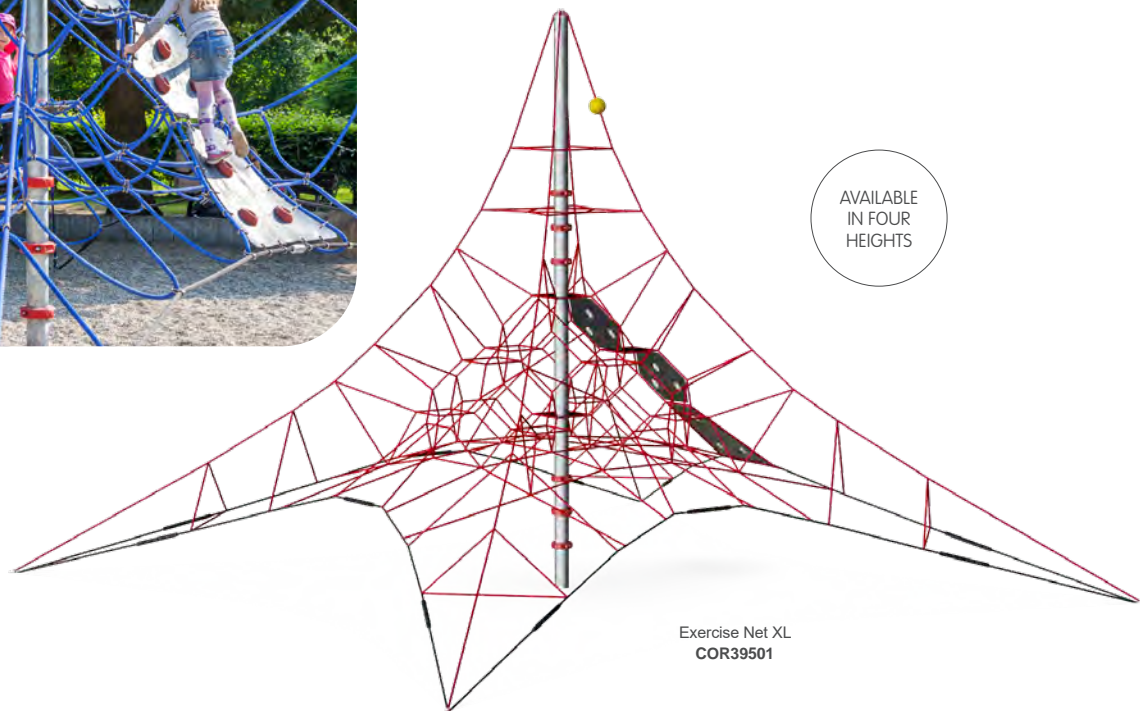

## PRODUCT INFORMATION

Product number	Product name	Age (years)	Capacity (users)	Fall height (ft & in)	Total height (ft & in)	Use zone dimensions (ft <sup>2</sup> )	Use zone dimensions (ft & in x ft & in)	Installation (hours)	Total CO <sub>2</sub> e (kg CO <sub>2</sub> e)
COR39301	Exercise Net S	5 - 12	25	6'0"	9'2"	543	25'1" x 25'1"	7.7	646
COR39331	Exercise Net M	2 - 5	30	5'11"	14'7"	958	34'5" x 34'5"	13	1,227
COR39401	Exercise Net L	5 - 12	38	6'5"	19'4"	1184	38'9" x 38'9"	16	1,532
COR39501	Exercise Net XL	5 - 12	42	8'2"	22'5"	1551	45'3" x 45'3"	19	2,129



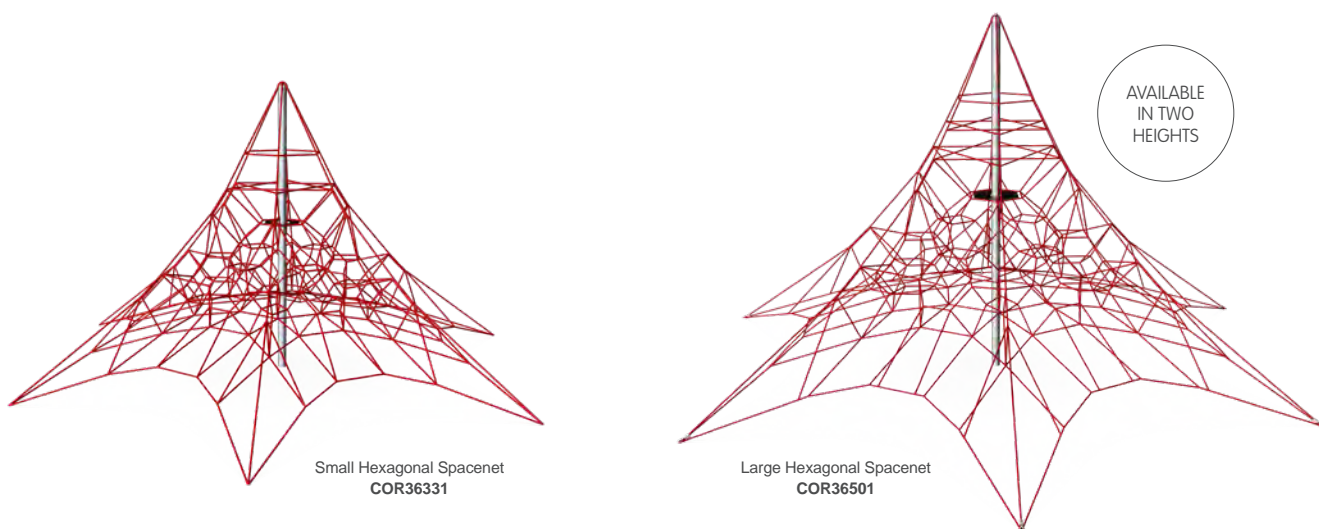

## PRODUCT INFORMATION

Product number	Product name	Age (years)	Capacity (users)	Fall height (ft & in)	Total height (ft & in)	Use zone dimensions (ft²)	Use zone dimensions (ft & in x ft & in)	Installation (hours)	Total CO <sub>2</sub> e (kg CO <sub>2</sub> e)
COR36331	Small Hexagonal Spacenet	2 - 5	34	3'3"	12'11"	896	37'2" x 33'10"	14	1,169
COR36501	Large Hexagonal Spacenet	5 - 12	49	6'0"	19'4"	1431	48'11" x 44'1"	20	1,721



# COROCORD™ SPACENET™



AVAILABLE  
IN TWO  
HEIGHTS

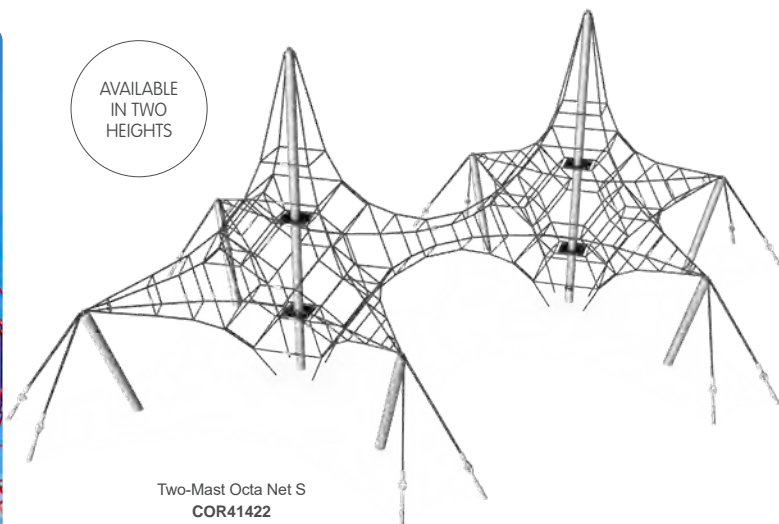

Two-Mast Octa Net S  
COR41422

AVAILABLE  
IN FOUR  
HEIGHTS

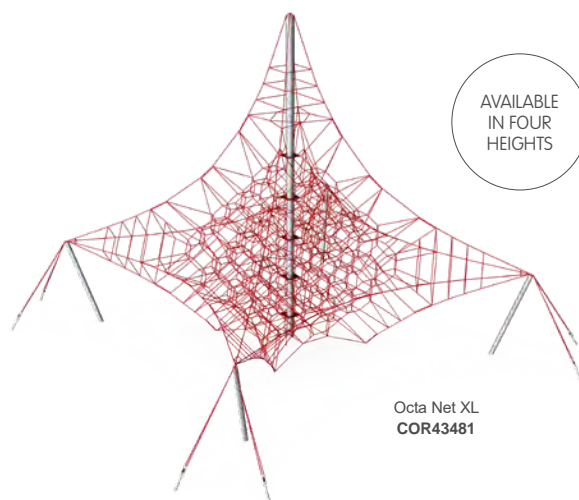

Octa Net XL  
COR43481

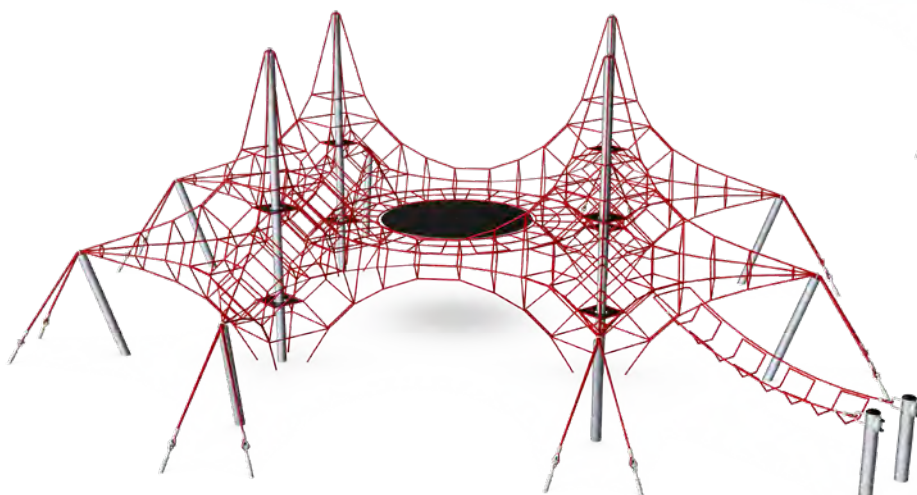

Four-Mast Octa Net + Bouncing Net  
COR10310

## PRODUCT INFORMATION

Product number	Product name	Age (years)	Capacity (users)	Fall height (ft & in)	Total height (ft & in)	Use zone dimensions (ft <sup>2</sup> )	Use zone dimensions (ft & in x ft & in)	Installation (hours)	Total CO <sub>2</sub> e (kg CO <sub>2</sub> e)
COR41422	Two-Mast Octa Net S	2 - 5	44	6'0"	12'8"	1310	49'5" x 36'3"	18	2,231
COR10310	Four-Mast Octa Net + Bouncing Net	2 - 5	103	6'0"	12'8"	2012	54'7" x 50'9"	36	4,026
COR41421	Octa Net S	2 - 5	22	6'0"	12'8"	844	32'2" x 32'2"	11	1,337
COR42401	Octa Net M	5 - 12	32	7'5"	19'8"	1344	42'10" x 42'10"	23	2,761
COR43401	Octa Net L	5 - 12	82	8'6"	28'7"	2062	55'4" x 55'4"	34	4,851
COR43481	Octa Net XL	5 - 12	129	9'10"	34'3"	2607	63'11" x 63'11"	50	6,134





**NEW**

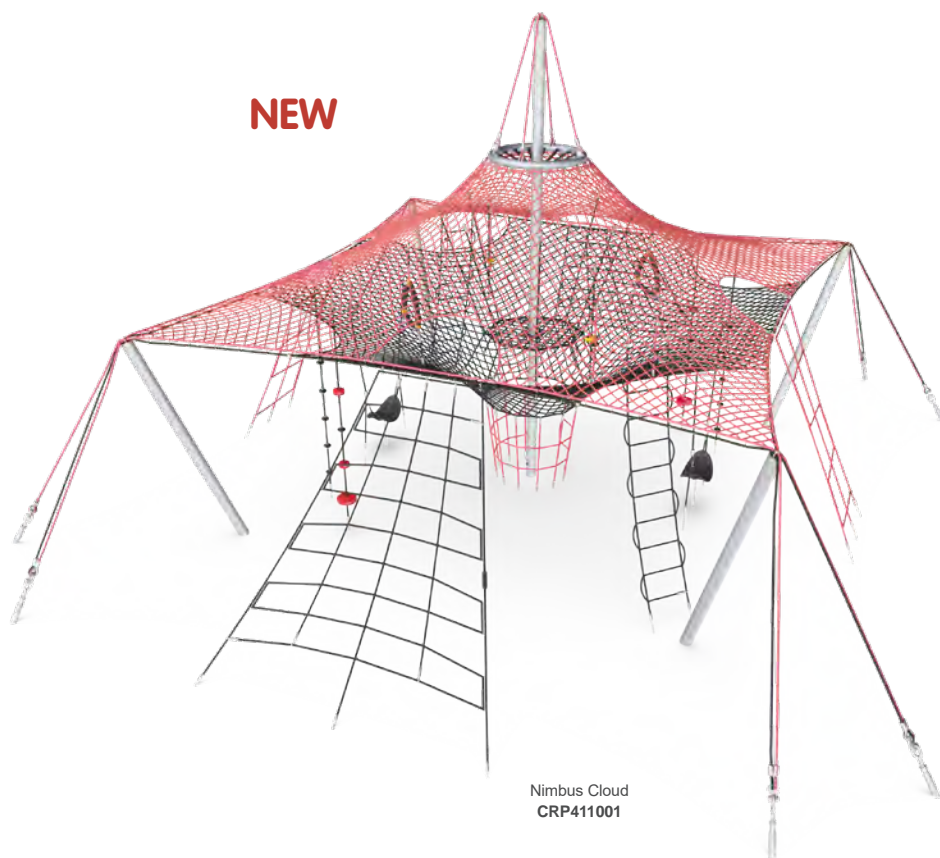

Nimbus Cloud  
CRP411001



**PRODUCT INFORMATION**

Product number	Product name	Age (years)	Capacity (users)	Fall height (ft & in)	Total height (ft & in)	Use zone dimensions (ft <sup>2</sup> )	Use zone dimensions (ft & in x ft & in)	Installation (hours)	Total CO <sub>2</sub> e (kg CO <sub>2</sub> e)
CRP411001	Nimbus Cloud	5 - 12	56	9'6"	20'0"	1991	48'4" x 47'11"	63	6,120



# FLEXIBILITY

With a variety of colors and part options, we offer lots of flexibility and customization with our standard products.

Post colors

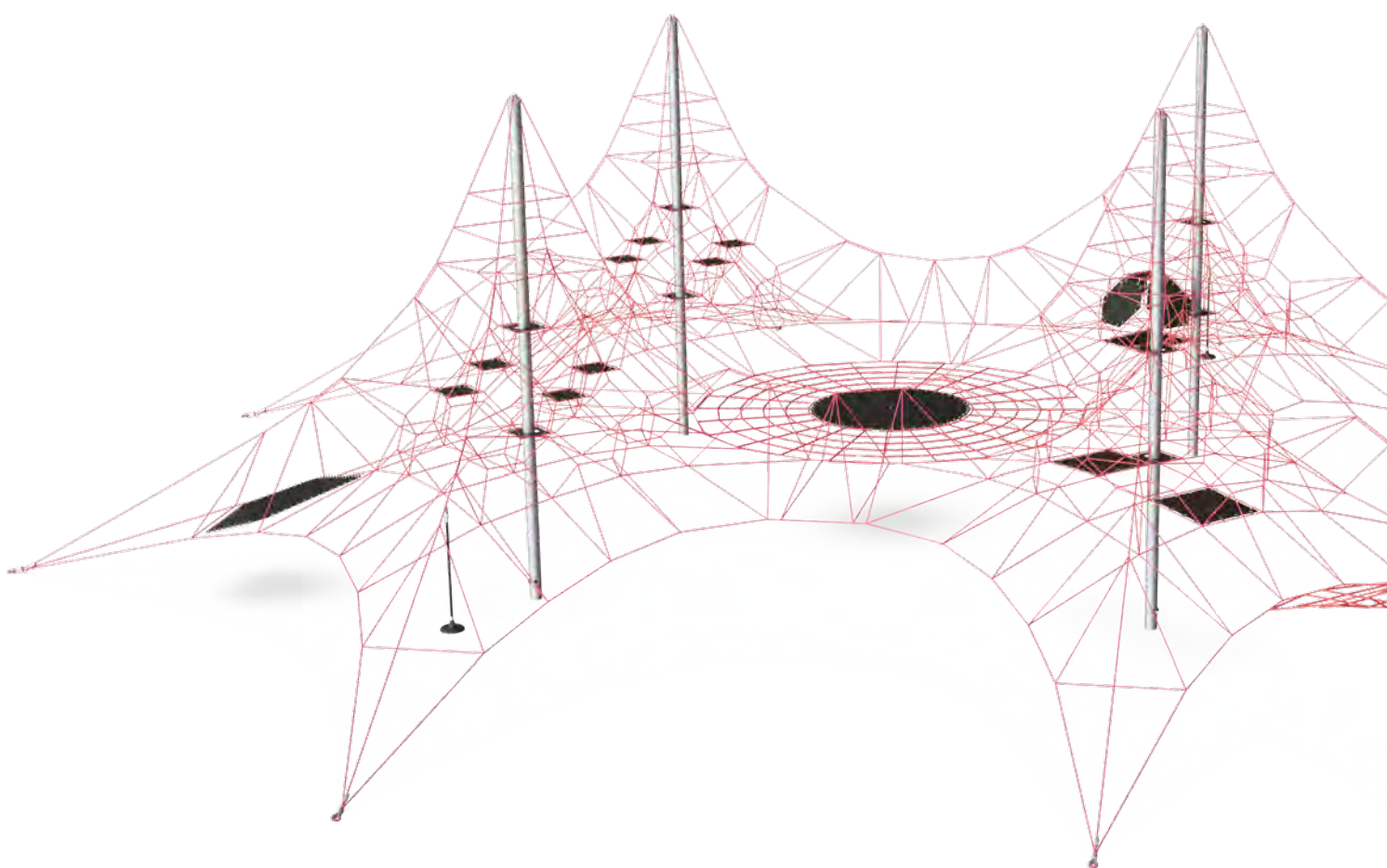

Rope colors





# OPTIONS

2525/2575: Twisted quadrangle amusement net



7010: Pendulum seats with suspension

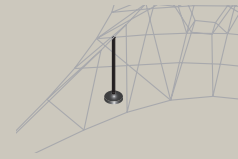

7020: Swinging nets



7030: Open stainless steel slide with rope net link



7040: Stainless steel tunnel slide with rope net link

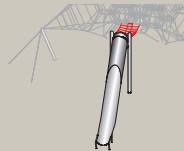

7100: Small seats

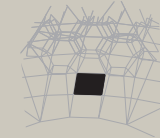

## Membrane colors

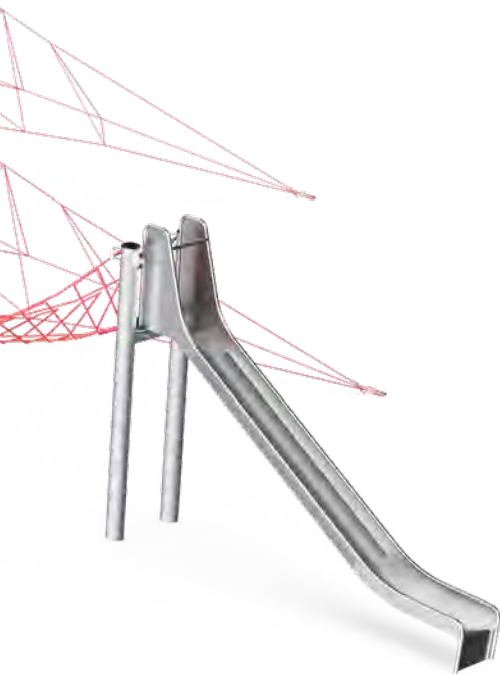

7200: Large seats of rubber membrane

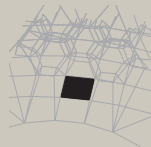

7300/7400: Houses/half houses

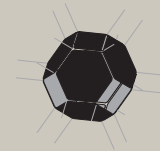

7500: Five-sided bouncing membranes

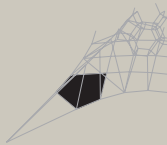

7600: Central circular membrane

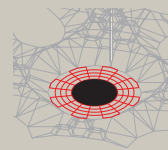

7650: Climbing funnel

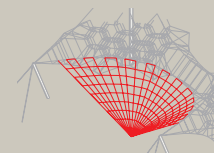

7800: Waggle bridges

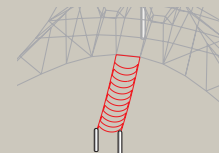

NOTE:  
Steel slides heated by the midday sun can cause severe skin burns. We recommend pointing steel slides away from the midday sun or using shading.

## More flexibility

Contact us for more information on the wide range of options for configurable playground equipment. Please note that prices and delivery terms depend on specified configurations.



**NEW**

# COROCORD™ MONKEY TRAILS MINI

## Trailblazing Play for the Youngest

Prepare to witness joyful laughter as children climb, swing, and balance their way through play spaces above and below. With age-appropriate challenges for 2-to-6-year-olds, the Monkey Trails Mini will continue to grow with children as it consists of play activities for the entire age span.

Together or alone and for many abilities, the Monkey Trails Mini has thrilling play activities for all.

See options on the FLEXIBILITY pages.



**For a greener future**  
Post-consumer recycled materials:

EcoCore™ Panels	>95%
Hollow Plastic Parts	33%
Hercules Rope Yarn	>95%
Molded Decks	75%

Steel parts adhere to industrial standards



Grove Trail  
CRP200102



Pathfinder Trail  
CRP200302



Wave Stepper  
CRP201201



Play Shell Climber  
CRP201101



Wonder Trail  
CRP200502



## PRODUCT INFORMATION

Product number	Product name	Age (years)	Capacity (users)	Fall height (ft & in)	Total height (ft & in)	Use zone dimensions (ft <sup>2</sup> )	Use zone dimensions (ft & in x ft & in)	Installation (hours)	Total CO <sub>2</sub> e (kg CO <sub>2</sub> e)
CRP200102	Grove Trail	2 - 5	5	1'3"	7'1"	316	22'2" x 16'8"	6.8	621
CRP200302	Pathfinder Trail	2 - 5	11	3'4"	7'1"	525	31'10" x 29'8"	11	1,123
CRP201201	Wave Stepper	2 - 5	4	0'11"	0'11"	270	21'6" x 14'2"	5	231
CRP201101	Play Shell Climber	2 - 5	5	2'0"	4'0"	250	18'8" x 16'10"	4.6	194
CRP200502	Wonder Trail	2 - 5	22	2'11"	7'3"	772	44'1" x 26'7"	25	1,864





Moss Hill  
CRP200202



No Return Trail  
CRP200402

## PRODUCT INFORMATION

Product number	Product name	Age (years)	Capacity (users)	Fall height (ft & in)	Total height (ft & in)	Use zone dimensions (ft²)	Use zone dimensions (ft & in x ft & in)	Installation (hours)	Total CO <sub>2</sub> e (kg CO <sub>2</sub> e)
CRP200202	Moss Hill	2 - 5	18	2'5"	9'9"	587	30'0" x 25'3"	14	1,016
CRP200402	No Return Trail	2 - 5	24	2'7"	11'2"	760	37'2" x 32'1"	23	1,862



**NEW**

# COROCORD™ MONKEY TRAILS MINI



Tree Stump Trail  
CRP200902



Meadow Trail  
CRP200602



Forest Fun Trail  
CRP200702



Expedite Trail  
CRP200802



Woodland Trail  
CRP201002

## PRODUCT INFORMATION

Product number	Product name	Age (years)	Capacity (users)	Fall height (ft & in)	Total height (ft & in)	Use zone dimensions (ft <sup>2</sup> )	Use zone dimensions (ft & in x ft & in)	Installation (hours)	Total CO <sub>2</sub> e (kg CO <sub>2</sub> e)
CRP200902	Tree Stump Trail	2 - 5	21	3'4"	7'1"	805	34'8" x 32'7"	18	1,623
CRP200602	Meadow Trail	2 - 5	26	2'11"	11'5"	941	46'1" x 27'2"	35	2,437
CRP200702	Forest Fun Trail	2 - 5	21	3'4"	7'1"	873	45'6" x 31'11"	18	1,827
CRP200802	Expedite Trail	2 - 5	36	2'7"	10'2"	1019	49'8" x 35'4"	37	2,934
CRP201002	Woodland Trail	2 - 5	52	2'7"	11'2"	1419	46'4" x 47'10"	53	4,224



# FLEXIBILITY

With a variety of colors and part options, we offer lots of flexibility and customization with our standard products.

## Color Concepts



Red



Green



Blue



Orange



Lime



Beige

# OPTIONS



PRODUCT CONFIGURATOR  
[www.kompan.com](http://www.kompan.com)

Rope trails, balancing, climbing and hang-outs



Play features and visuals



Interlinked Product Solution



## More flexibility

Contact us for more information on the wide range of options for configurable playground equipment. Please note that prices and delivery terms depend on specified configurations.



# COROCORD™ MONKEY TRAILS

## Get in Motion!

No other play equipment offers so many different opportunities to get in motion and use mind and body skills as the Corocord Monkey Trails do. Balancing, bouncing, climbing, spinning, and sliding are all possible activities. The children have to navigate and find ways through the complex rope-and-activity jungle.

Brace yourselves for a wild climb of endless possibilities to get body and mind in motion like never before.

See options on the FLEXIBILITY page.



Gorilla Trail  
CRP250602



### For a greener future

#### Post-consumer recycled materials:

EcoCore™ Panels	>95%
Hollow Plastic Parts	33%
Hercules Rope Yarn	>95%
Molded Decks	75%

Steel parts adhere to industrial standards

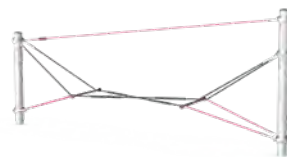

Galago Trail  
CRP250101

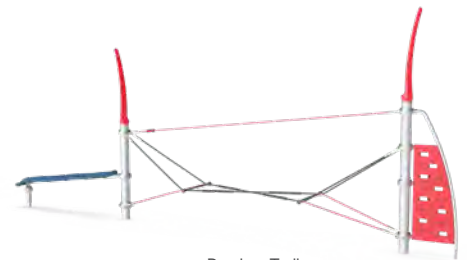

Bamboo Trail  
CRP250201

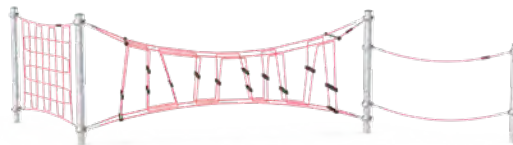

Baboon Trail  
CRP250301

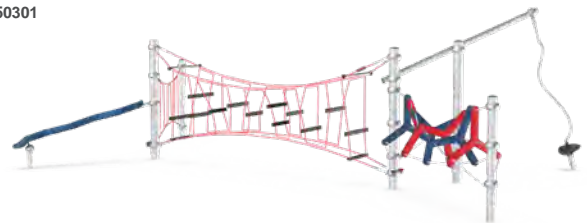

Chimpanzee Trail  
CRP250401



Cabin Trail  
CRP250502

## PRODUCT INFORMATION

Product number	Product name	Age (years)	Capacity (users)	Fall height (ft & in)	Total height (ft & in)	Use zone dimensions (ft <sup>2</sup> )	Use zone dimensions (ft & in x ft & in)	Installation (hours)	Total CO <sub>2</sub> e (kg CO <sub>2</sub> e)
CRP250602	Gorilla Trail	5 - 12	18	7'10"	8'5"	630	28'8" x 30'2"	23	1,888
CRP250101	Galago Trail	5 - 12	8	1'3"	8'5"	405	31'9" x 15'2"	6.6	718
CRP250201	Bamboo Trail	5 - 12	10	6'1"	13'5"	558	43'12" x 15'2"	11	1,046
CRP250301	Baboon Trail	5 - 12	13	7'10"	8'5"	649	44'11" x 25'8"	20	1,257
CRP250401	Chimpanzee Trail	5 - 12	16	7'10"	10'8"	931	44'11" x 33'4"	30	2,128
CRP250502	Cabin Trail	5 - 12	16	7'10"	8'5"	602	28'8" x 28'5"	20	1,478



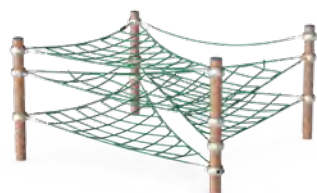

Spix's Trail  
CRP250701



Mountain Trail  
CRP250802



Roloway Trail  
CRP250901



Kipunji Trail  
CRP251001

## PRODUCT INFORMATION

Product number	Product name	Age (years)	Capacity (users)	Fall height (ft & in)	Total height (ft & in)	Use zone dimensions (ft <sup>2</sup> )	Use zone dimensions (ft & in x ft & in)	Installation (hours)	Total CO <sub>2</sub> e (kg CO <sub>2</sub> e)
CRP250701	Spix's Trail	5 - 12	12	4'11"	5'6"	457	22'2" x 22'2"	16	1,013
CRP250802	Mountain Trail	5 - 12	20	6'1"	13'1"	811	37'6" x 31'1"	28	2,334
CRP250901	Roloway Trail	5 - 12	20	3'11"	5'6"	735	31'6" x 31'6"	20	1,275
CRP251001	Kipunji Trail	5 - 12	32	7'0"	12'1"	797	38'4" x 34'5"	35	2,143



# COROCORD™ MONKEY TRAILS



Saimiri Trail  
CRP251401

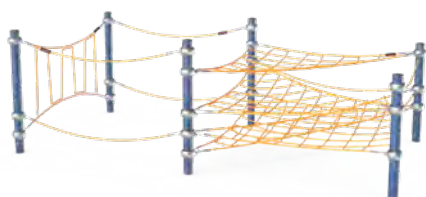

Howler Trail  
CRP251101



Javan Trail  
CRP251201

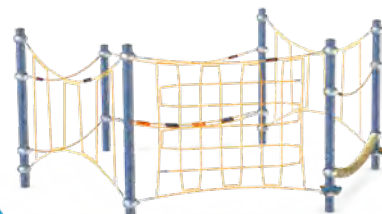

Honeycomb Trail  
CRP251301



Forest Trail  
CRP251501

## PRODUCT INFORMATION

Product number	Product name	Age (years)	Capacity (users)	Fall height (ft & in)	Total height (ft & in)	Use zone dimensions (ft <sup>2</sup> )	Use zone dimensions (ft & in x ft & in)	Installation (hours)	Total CO <sub>2</sub> e (kg CO <sub>2</sub> e)
CRP251401	Saimiri Trail	5 - 12	24	7'10"	11'5"	1001	32'3" x 45'7"	30	2,839
CRP251101	Howler Trail	5 - 12	24	4'11"	6'6"	670	31'9" x 22'2"	22	1,495
CRP251201	Javan Trail	5 - 12	30	7'10"	10'9"	918	47'0" x 28'9"	27	2,739
CRP251301	Honeycomb Trail	5 - 12	20	7'10"	8'5"	710	31'9" x 29'2"	16	1,698
CRP251501	Forest Trail	5 - 12	42	8'10"	9'5"	1851	59'4" x 76'7"	40	3,535



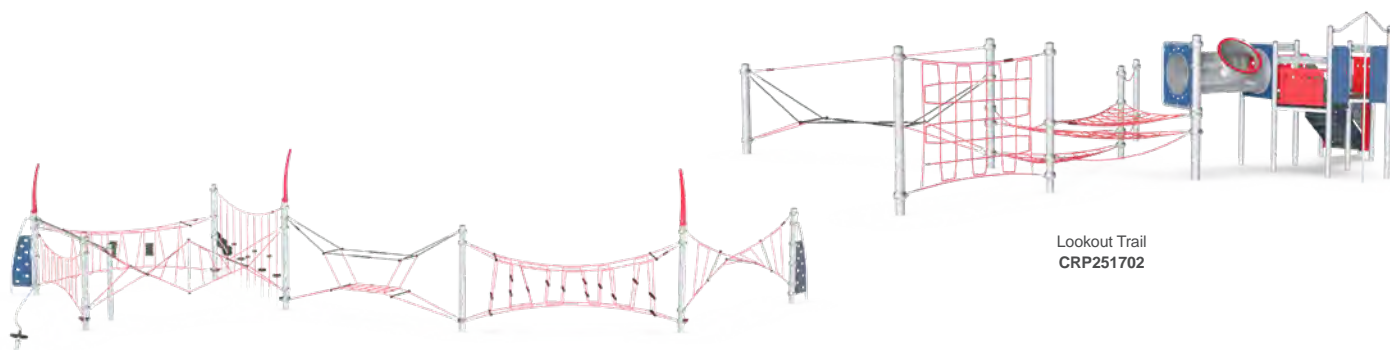

Tantalus Trail  
CRP251601

Lookout Trail  
CRP251702

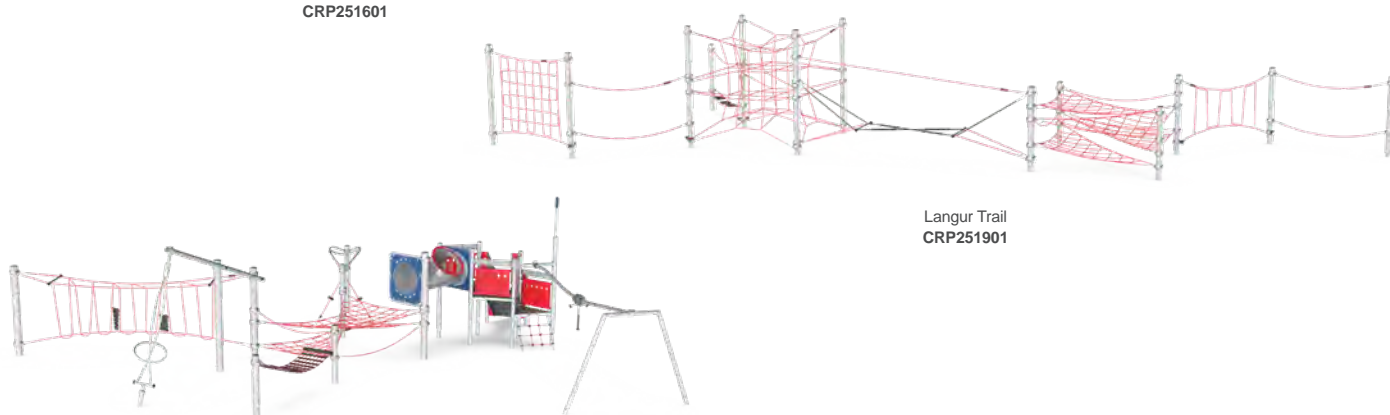

Canopy Trail  
CRP251802

Langur Trail  
CRP251901

## PRODUCT INFORMATION

Product number	Product name	Age (years)	Capacity (users)	Fall height (ft & in)	Total height (ft & in)	Use zone dimensions (ft <sup>2</sup> )	Use zone dimensions (ft & in x ft & in)	Installation (hours)	Total CO <sub>2</sub> e (kg CO <sub>2</sub> e)
CRP251601	Tantalus Trail	5 - 12	50	8'10"	15'5"	2134	65'10" x 86'3"	41	4,764
CRP251702	Lookout Trail	5 - 12	30	7'10"	10'2"	1267	46'10" x 53'6"	36	3,193
CRP251802	Canopy Trail	5 - 12	34	7'0"	12'7"	1677	46'10" x 64'3"	44	4,161
CRP251901	Langur Trail	5 - 12	47	9'6"	10'1"	1636	83'2" x 35'9"	65	4,071



# COROCORD™ MONKEY TRAILS

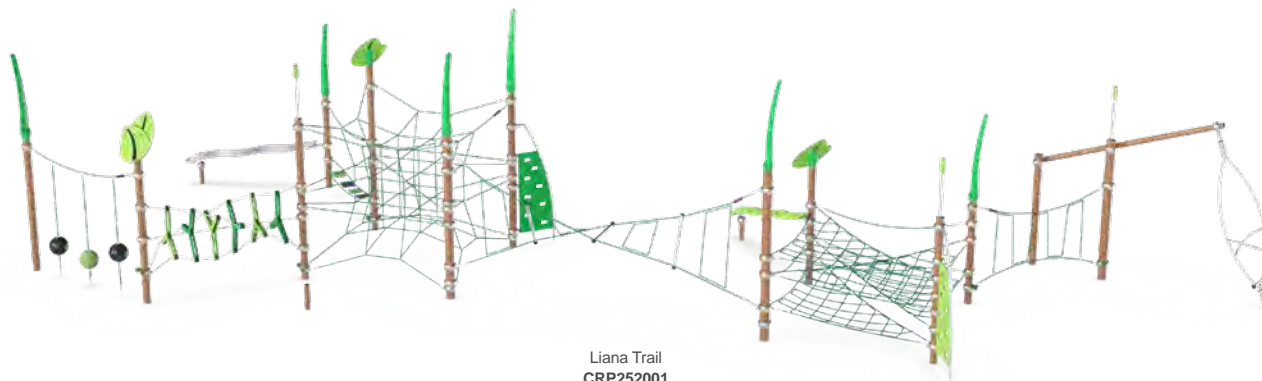

Liana Trail  
CRP252001



Hamadryad Trail  
CRP252101



Cave Trail  
CRP252201

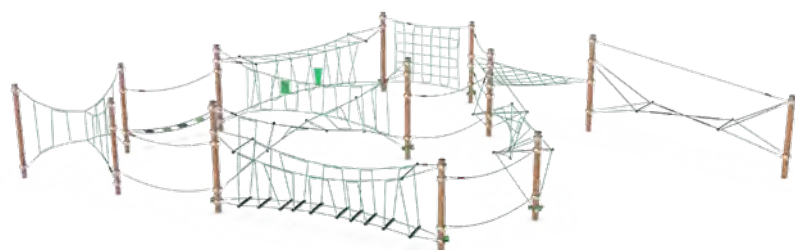

Cottontop Trail  
CRP252301



Giant Bamboo Trail  
CRP252401

## PRODUCT INFORMATION

Product number	Product name	Age (years)	Capacity (users)	Fall height (ft & in)	Total height (ft & in)	Use zone dimensions (ft <sup>2</sup> )	Use zone dimensions (ft & in x ft & in)	Installation (hours)	Total CO <sub>2</sub> e (kg CO <sub>2</sub> e)
CRP252001	Liana Trail	5 - 12	53	9'6"	15'2"	1950	83'6" x 35'9"	80	5,538
CRP252101	Hamadryad Trail	5 - 12	90	8'10"	9'5"	2709	74'8" x 56'9"	70	5,422
CRP252201	Cave Trail	5 - 12	100	9'6"	15'2"	3224	75'0" x 65'9"	91	9,535
CRP252301	Cottontop Trail	5 - 12	64	8'10"	9'5"	2301	73'1" x 47'2"	70	5,378
CRP252401	Giant Bamboo Trail	5 - 12	68	8'10"	15'5"	2482	72'9" x 57'3"	110	6,842





If you want a uniquely designed landmark playground, our KOMPAN Design Studio can help make your special place come true.

For example, see the Monkey Trail below, uniquely designed by KOMPAN Design Studio.





# FLEXIBILITY

With a variety of colors and part options, we offer lots of flexibility and customization with our standard products.

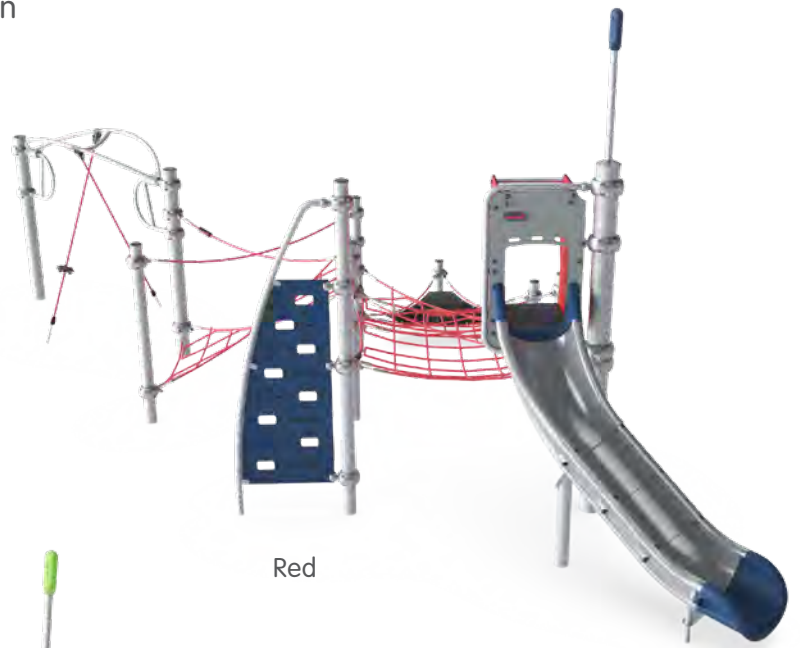

Red



Green



Orange

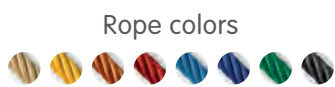





## Rope trails

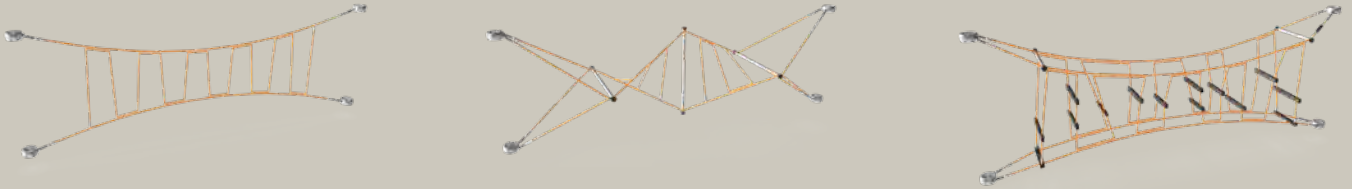

## Climbers and box nets

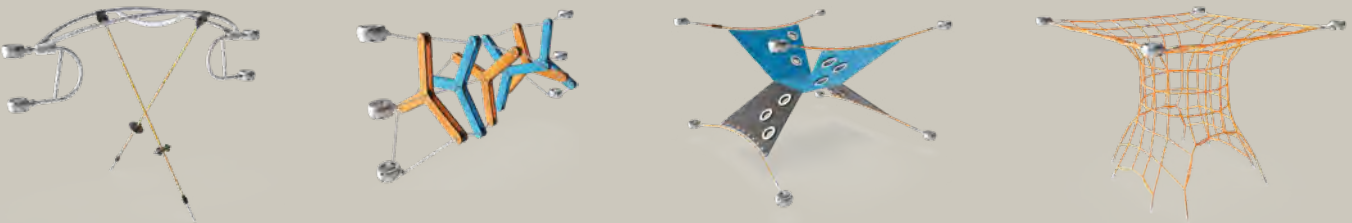

## Hammocks and extensions



## Slides



NOTE:  
Steel slides heated by the midday sun can cause severe skin burns. We recommend pointing steel slides away from the midday sun or using PE slides or shading.

## Post theming



## Stepstones and membranes



## More flexibility

Contact us for more information on the wide range of options for configurable playground equipment. Please note that prices and delivery terms depend on specified configurations.



# COROCORD™ EARLY CLIMBING

## Fun for the Little Climbers

Climbing is fun and an important skill for a child to master, especially in the younger years. When climbing, the child develops cross-coordination skills, stimulating the two hemispheres of the brain and ultimately helping the child learn to read.

Get on the climbing path! Even young, more insecure climbers can get a fun and developmental experience.

AVAILABLE  
IN TWO  
HEIGHTS



### For a greener future

Post-consumer recycled materials:

Hercules Rope Yarn

>95%

Steel parts adhere to industrial standards



Spida  
COR20100

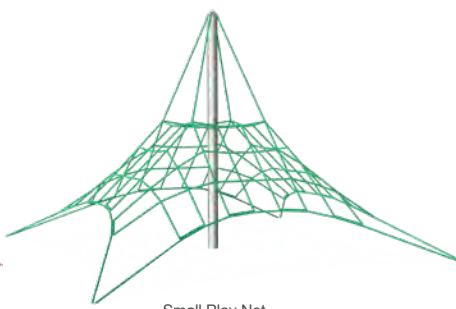

Small Play Net  
COR23401



Crumb Net  
COR24301

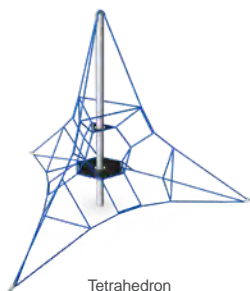

Tetrahedron  
COR24501

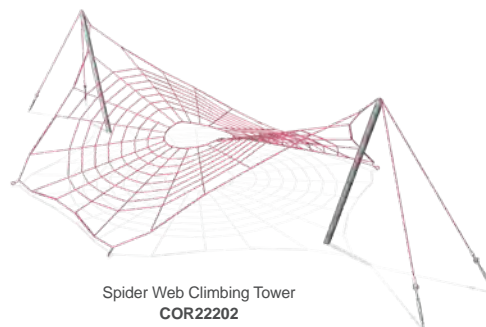

Spider Web Climbing Tower  
COR22202

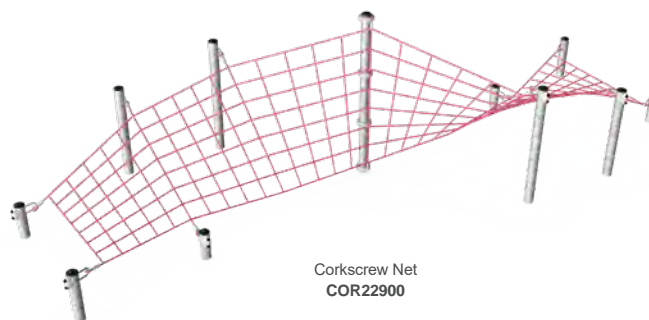

Corkscrew Net  
COR22900

## PRODUCT INFORMATION

Product number	Product name	Age (years)	Capacity (users)	Fall height (ft & in)	Total height (ft & in)	Use zone dimensions (ft²)	Use zone dimensions (ft & in x ft & in)	Installation (hours)	Total CO <sub>2</sub> e (kg CO <sub>2</sub> e)
COR20200	Arch Ladder, 4 ft	2 - 5	15	4'3"	4'3"	293	21'10" x 14'10"	4.8	361
COR20100	Spida	2 - 5	12	5'7"	9'6"	421	23'4" x 20'10"	5.7	412
COR23401	Small Play Net	2 - 5	11	4'7"	8'6"	552	30'7" x 30'7"	4.8	560
COR24301	Crumb Net	2 - 5	12	3'11"	7'10"	353	21'2" x 21'2"	7.7	508
COR24501	Tetrahedron	2 - 5	10	3'7"	9'6"	433	25'6" x 23'8"	6.6	453
COR22202	Spider Web Climbing Tower	5 - 12	33	7'7"	9'10"	1481	58'6" x 36'5"	11	1,293
COR22900	Corkscrew Net	5 - 12	18	8'2"	8'2"	863	44'6" x 25'7"	14	1,562



DESIGNED TO INSPIRE

# Inspirational Playground Concepts

Our skilled designers at KOMPAN Design Studio can take any idea or concept from sketch to real-life architectural playground landmarks.

Embark on your playground journey with our Inspirational Playground Concepts to find the perfect idea for your community, municipality, or school.

Find an exciting selection of more than 30 inspirational designs on our website.



**KOMPAN**  
Let's play



# COROCORD™ PLAY BRIDGES

## Bridging the Gap Between Play and Imagination

Imagine the sheer bravery it takes to keep stepping forward, suspended high in the air, peering down at the ground below. That's just thrilling! A trip across the bridge boosts the child's self-confidence and trains the child's spatial awareness.

Take the obvious route across the bridge, or explore an entire world of fun above and below, just waiting to be discovered.



### For a greener future

Post-consumer recycled materials:

Hercules Rope Yarn

>95%

Steel parts adhere to industrial standards

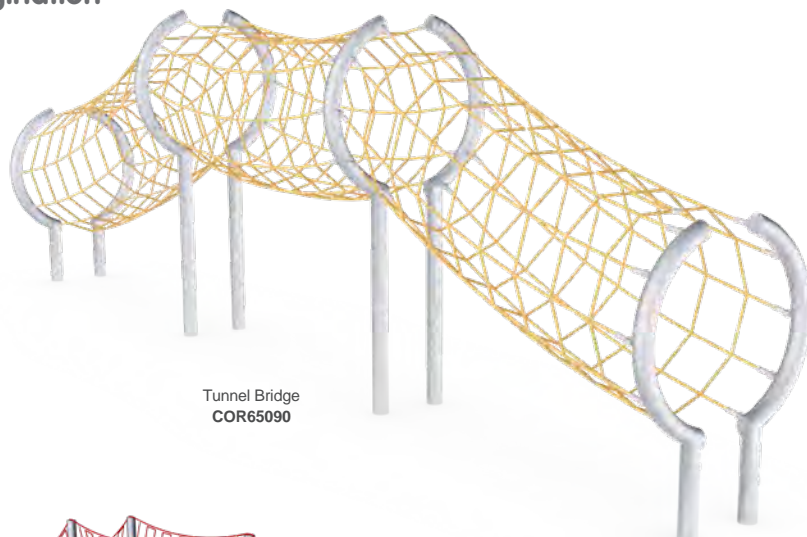

Tunnel Bridge  
COR65090



Bridge with Wooden Slats, 39 ft  
COR64120

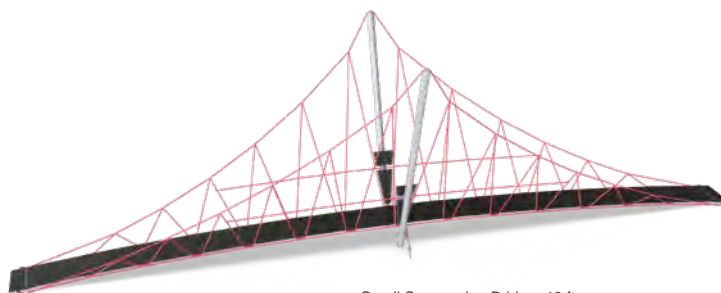

Small Suspension Bridge, 46 ft  
COR62140



Small Rope Bridge, 29 ft  
COR66120



## PRODUCT INFORMATION

Product number	Product name	Age (years)	Capacity (users)	Fall height (ft & in)	Total height (ft & in)	Use zone dimensions (ft <sup>2</sup> )	Use zone dimensions (ft & in x ft & in)	Installation (hours)	Total CO <sub>2</sub> e (kg CO <sub>2</sub> e)
COR65090	Tunnel Bridge	5 - 12	27	9'0"	9'0"	658	42'3" x 16'4"	11	1,773
COR64120	Bridge with Wooden Slats, 39 ft	5 - 12	24	6'1"	9'7"	847	52'7" x 16'9"	30	2,732
COR62140	Small Suspension Bridge, 46 ft	5 - 12	32	3'3"	13'8"	935	60'11" x 15'10"	19	2,596
COR66120	Small Rope Bridge, 29 ft	5 - 12	24	6'9"	9'6"	802	52'7" x 16'2"	12	1,812





Net Bridge with Coconut Rope, 39 ft  
COR63120

## PRODUCT INFORMATION

Product number	Product name	Age (years)	Capacity (users)	Fall height (ft & in)	Total height (ft & in)	Use zone dimensions (ft <sup>2</sup> )	Use zone dimensions (ft & in x ft & in)	Installation (hours)	Total CO <sub>2</sub> e (kg CO <sub>2</sub> e)
COR63120	Net Bridge with Coconut Rope, 39 ft	5 - 12	20	7'5"	9'7"	791	53'0" x 15'12"	4.4	2,171



# COROCORD™ FRAME NETS

## Enter the Realm of Three-Dimensional Play

Frame Nets are gateways to a vibrant, three-dimensional playground where kids rule the domain of fun and exploration. As children climb from one rope to another, a symphony of coordination unfolds their cross-coordination skills and enhances physical strength.

With every twist and turn, young minds ignite with the power of logic and problem-solving while unravelling mysteries on the way to the top.

See options on the FLEXIBILITY page.

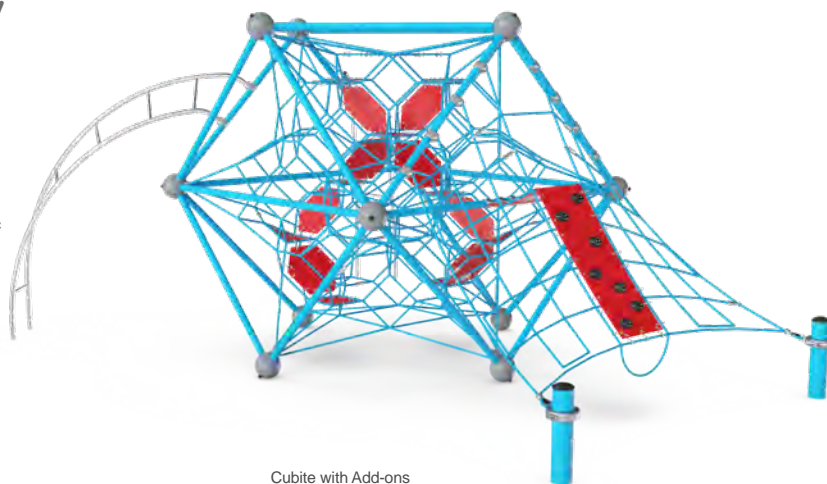

Cubite with Add-ons  
**COR10503**



### For a greener future

#### Post-consumer recycled materials:

EcoCore™ Panels  
Hercules Rope Yarn

>95%  
>95%

Steel parts adhere to industrial standards

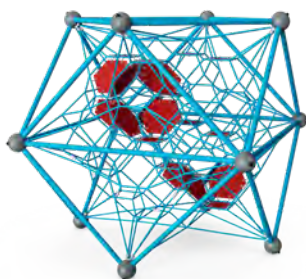

Cubite with House Membrane  
**COR10501**

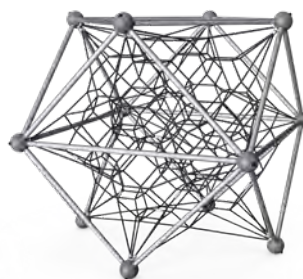

Cubite  
**COR48330**



Circite  
**COR46330**

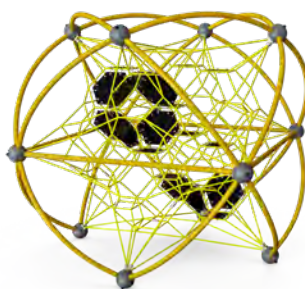

Circite with House Membrane  
**COR10481**



Circite Flowite  
**COR10484**

## PRODUCT INFORMATION

Product number	Product name	Age (years)	Capacity (users)	Fall height (ft & in)	Total height (ft & in)	Use zone dimensions (ft <sup>2</sup> )	Use zone dimensions (ft & in x ft & in)	Installation (hours)	Total CO <sub>2</sub> e (kg CO <sub>2</sub> e)
<b>COR10503</b>	Cubite with Add-ons	5 - 12	42	9'10"	9'10"	739	35'9" x 35'8"	30	2,533
<b>COR10501</b>	Cubite with House Membrane	5 - 12	30	9'10"	9'10"	438	25'7" x 25'7"	21	1,864
<b>COR48330</b>	Cubite	5 - 12	30	9'10"	9'10"	438	25'7" x 25'7"	20	1,732
<b>COR46330</b>	Circite	2 - 5	30	9'10"	10'3"	456	25'7" x 25'7"	21	1,753
<b>COR10481</b>	Circite with House Membrane	2 - 5	30	9'10"	10'3"	456	25'7" x 25'7"	21	1,885
<b>COR10484</b>	Circite Flowite	2 - 5	35	9'10"	10'8"	593	32'10" x 27'4"	28	2,406





Dragite Dragonite  
COR10494



Dragite with House Membrane  
COR10491

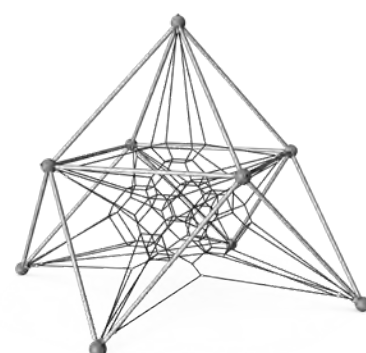

Dragite  
COR47330

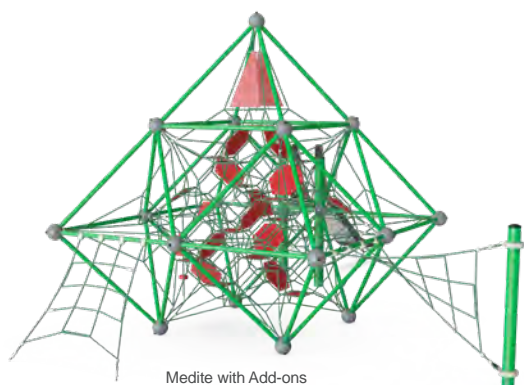

Medite with Add-ons  
COR10513

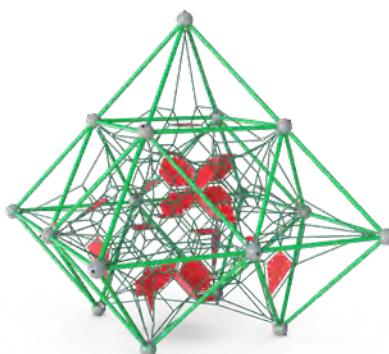

Medite with House Membrane  
COR10511

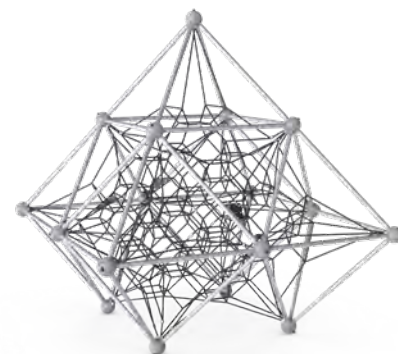

Medite  
COR49330

## PRODUCT INFORMATION

Product number	Product name	Age (years)	Capacity (users)	Fall height (ft & in)	Total height (ft & in)	Use zone dimensions (ft <sup>2</sup> )	Use zone dimensions (ft & in x ft & in)	Installation (hours)	Total CO <sub>2</sub> e (kg CO <sub>2</sub> e)
COR10494	Dragite Dragonite	5 - 12	45	7'7"	14'4"	722	26'4" x 32'11"	39	2,348
COR10491	Dragite with House Membrane	5 - 12	28	7'7"	14'4"	650	26'4" x 26'4"	16	1,551
COR47330	Dragite	5 - 12	28	7'7"	14'4"	650	26'4" x 26'4"	15	1,376
COR10513	Medite with Add-ons	5 - 12	46	5'9"	14'8"	905	32'5" x 41'8"	41	4,001
COR10511	Medite with House Membrane	5 - 12	31	5'5"	14'8"	625	25'10" x 25'10"	30	2,721
COR49330	Medite	5 - 12	31	5'5"	14'8"	625	25'10" x 25'10"	29	2,558



# COROCORD™ FRAME NETS

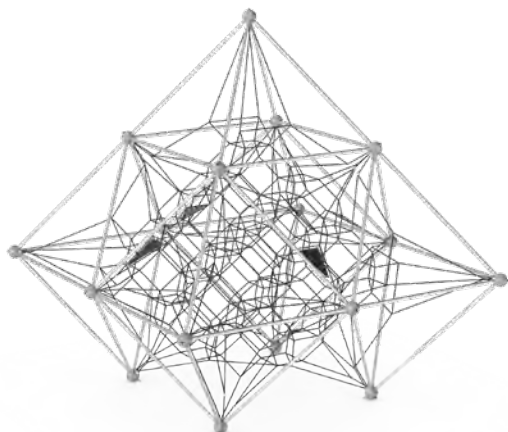

Maxite  
COR49480



Maxite with Add-ons  
COR10524

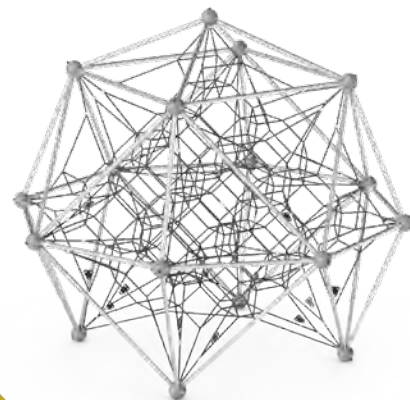

Octanite  
COR45400

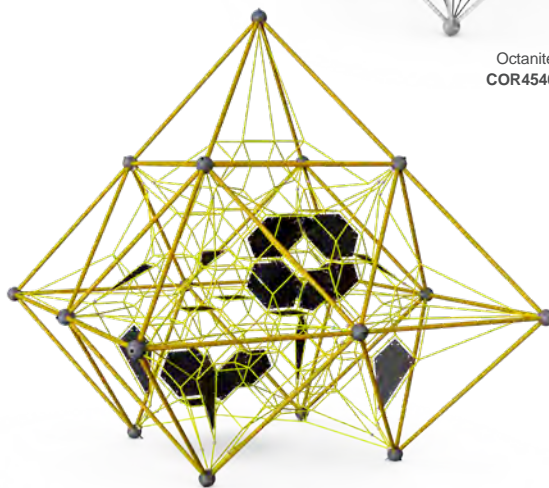

Maxite with House Membrane  
COR10521

## PRODUCT INFORMATION

Product number	Product name	Age (years)	Capacity (users)	Fall height (ft & in)	Total height (ft & in)	Use zone dimensions (ft²)	Use zone dimensions (ft & in x ft & in)	Installation (hours)	Total CO <sub>2</sub> e (kg CO <sub>2</sub> e)
COR10524	Maxite with Add-ons	5 - 12	76	7'5"	20'12"	1375	52'5" x 36'3"	63	5,018
COR49480	Maxite	5 - 12	45	7'5"	20'12"	969	31'10" x 31'10"	35	3,287
COR45400	Octanite	5 - 12	36	6'8"	15'1"	648	29'7" x 29'7"	31	2,716
COR10521	Maxite with House Membrane	5 - 12	45	7'5"	20'12"	969	31'10" x 31'10"	37	3,599



# FLEXIBILITY

With a variety of colors and part options, we offer lots of flexibility and customization with our standard products.

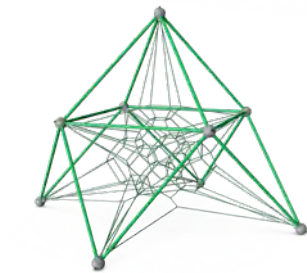
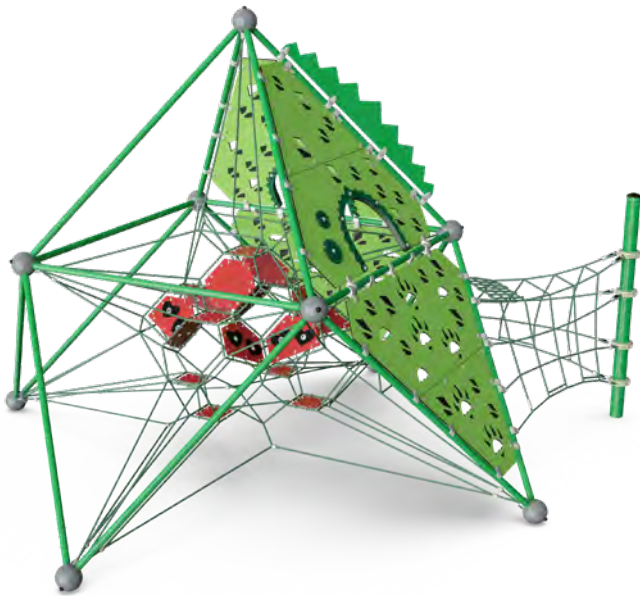

Dragite Core

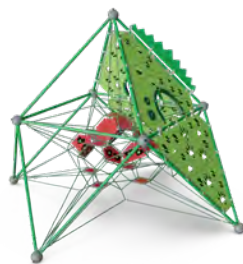

Themed Panels

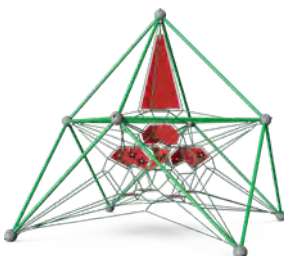

Membrane Elements

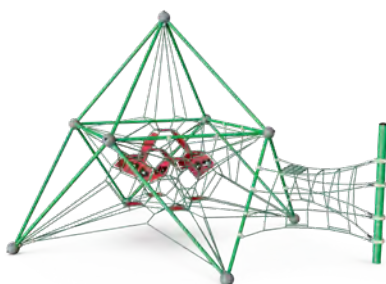
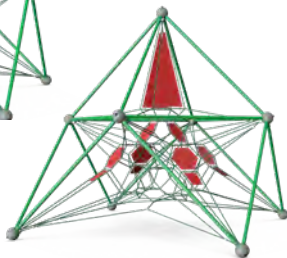

Add-ons

# OPTIONS



PRODUCT CONFIGURATOR  
[www.kompan.com](http://www.kompan.com)

## COLOR THEMES

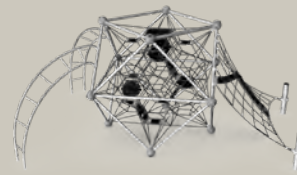

Luna



Mars

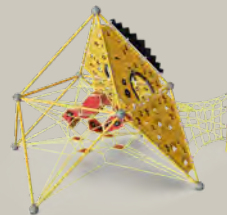

Solaris

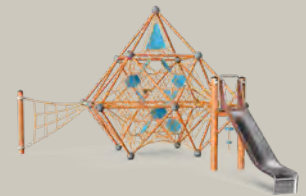

Venus

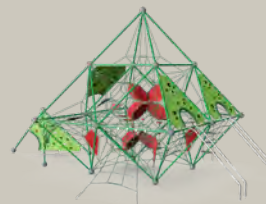

Terra

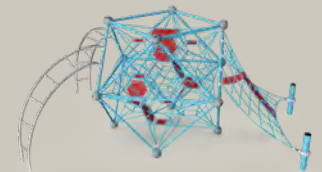

Neptune

## More flexibility

Contact us for more information on the wide range of options for configurable playground equipment. Please note that prices and delivery terms depend on specified configurations.







# NATURE PLAY





# ROBINIA FANTASY

## Escape to the Forest of Fantasy

In the enchanting realm of the fantasy universe, imagination and play intertwine. The quirky expression of the Robinia Fantasy play structures is unique and on nature's terms. The signature posts get their authentic woodgrain pattern from when they were forested in their natural state.

Climb towards the eternal battle between good and evil, or swing to escape the Warlock's magic spell.

See options on the FLEXIBILITY pages.



### For a greener future

#### Robinia wood:

Nature's own material, harvested from European forestry. Robinia wood is known for its natural preservatives that make it long lasting in the outdoors.



Crooked Den  
NRC200101



Stack & Turn Play Panel  
NRC60101



Triple Wonder Play Panel  
NRC60201

## PRODUCT INFORMATION

All Robinia products are available as FSC®-certified

Product number	Product name	Age (years)	Capacity (users)	Fall height (ft & in)	Total height (ft & in)	Use zone dimensions (ft²)	Use zone dimensions (ft & in x ft & in)	Installation (hours)	Total CO <sub>2</sub> e (kg CO <sub>2</sub> e)
NRC200101	Crooked Den	2 - 5	13	1'11"	11'1"	643	31'4" x 25'8"	30	-
NRC60101	Stack & Turn Play Panel	2 - 5	2	0'0"	3'3"	189	17'0" x 13'6"	3.6	-
NRC60201	Triple Wonder Play Panel	2 - 5	6	0'0"	4'3"	281	22'0" x 16'0"	5.7	-





Please note that each Robinia Fantasy structure will have its own unique appearance. Shaped by nature, natural variations will occur.



Hideaway Cottage  
NRC100401



Spellbound Shack  
NRC200201

## PRODUCT INFORMATION

All Robinia products are available as FSC®-certified

Product number	Product name	Age (years)	Capacity (users)	Fall height (ft & in)	Total height (ft & in)	Use zone dimensions (ft²)	Use zone dimensions (ft & in x ft & in)	Installation (hours)	Total CO <sub>2</sub> e (kg CO <sub>2</sub> e)
NRC100401	Hideaway Cottage	2 - 5	11	3'11"	13'12"	592	31'11" x 28'2"	41	-
NRC200201	Spellbound Shack	2 - 5	21	3'10"	15'3"	857	40'9" x 34'1"	51	-



# ROBINIA FANTASY



Bewitched Tower  
NRC200401



Enchanted Shed  
NRC300101



Warlock's Escape  
NRC400101

Please note that each Robinia Fantasy structure will have its own unique appearance. Shaped by nature, natural variations will occur.

## PRODUCT INFORMATION

All Robinia products are available as FSC®-certified

Product number	Product name	Age (years)	Capacity (users)	Fall height (ft & in)	Total height (ft & in)	Use zone dimensions (ft²)	Use zone dimensions (ft & in x ft & in)	Installation (hours)	Total CO <sub>2</sub> e (kg CO <sub>2</sub> e)
NRC200401	Bewitched Tower	5 - 12	20	6'0"	16'6"	625	29'9" x 29'4"	42	-
NRC300101	Enchanted Shed	5 - 12	30	6'2"	16'6"	1292	39'10" x 43'4"	130	-
NRC400101	Warlock's Escape	5 - 12	34	6'2"	17'9"	1576	51'10" x 45'11"	140	-



# FLEXIBILITY

With a variety of colors and part options, we offer lots of flexibility and customization with our standard products.



Untreated



Transparent Brown



Colored

# OPTIONS



PRODUCT CONFIGURATOR  
[www.kompan.com](http://www.kompan.com)

## Roof options



## Links and extensions

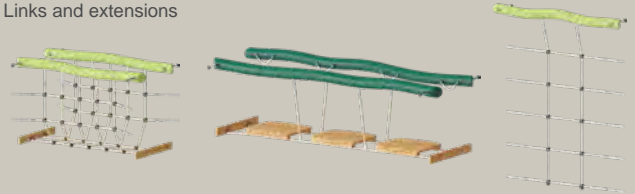

## PE slides



## PE slide colors



## Stainless steel slides and activities

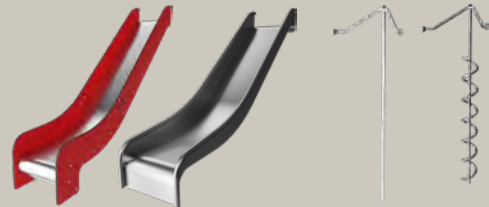

## NOTE:

Steel slides heated by the midday sun can cause severe skin burns. We recommend pointing steel slides away from the midday sun or using PE slides or shading.

## Footings



Wood in-ground



Hot-dip galvanized

## More flexibility

Contact us for more information on the wide range of options for configurable playground equipment. Please note that prices and delivery terms depend on specified configurations.



# ROBINIA VILLAGE

## It Takes a Village

The Robinia product portfolio is a collection of organic play structures with something for everyone - from enchanting playhouses designed for the youngest to large play structures for the oldest.

Robinia structures add a natural look to suburban landscapes or infuse an organic touch into bustling cityscapes. Whether you want your playground to stand out or blend in, Robinia is your answer.

See options on the FLEXIBILITY page.



### For a greener future

#### Robinia wood:

Nature's own material, harvested from European forestry. Robinia wood is known for its natural preservatives that make it long lasting in the outdoors.



The Wizard's Hideaway  
NRO409



Village Shop  
NRO404



Village House  
NRO405



Forest Shop  
NRO407



Forest Cottage  
NRO408



Playhouse with Roof  
NRO401



Playhouse with Roof & Wall  
NRO402

## PRODUCT INFORMATION

All Robinia products are available as FSC®-certified

Product number	Product name	Age (years)	Capacity (users)	Fall height (ft & in)	Total height (ft & in)	Use zone dimensions (ft²)	Use zone dimensions (ft & in x ft & in)	Installation (hours)	Total CO <sub>2</sub> e (kg CO <sub>2</sub> e)
NRO409	The Wizard's Hideaway	2 - 5	11	2'11"	10'9"	475	21'7" x 26'10"	27	382
NRO404	Village Shop	2 - 5	6	0'0"	8'5"	-	0'0" x 0'0"	10	113
NRO405	Village House	2 - 5	8	1'7"	9'5"	306	20'8" x 17'9"	16	153
NRO407	Forest Shop	2 - 5	7	0'0"	8'6"	-	0'0" x 0'0"	9.6	97
NRO408	Forest Cottage	2 - 5	8	1'7"	9'7"	310	20'8" x 17'12"	16	156
NRO401	Playhouse with Roof	2 - 5	4	0'0"	8'6"	-	0'0" x 0'0"	4.9	47
NRO402	Playhouse with Roof & Wall	2 - 5	5	0'0"	8'6"	-	0'0" x 0'0"	6.9	63





Play Tower with Slide & Banister Bars  
**NRO1018**



Play Tower with Slide  
**NRO1019**



Double Tower with Double Slide  
**NRO2007**



Track Ride Tower  
**NRO1022**



Robinia Cliff Rider, 8 ft H  
**NRO3002**



Robinia Cliff Rider, 8 ft H  
**NRO3003**

**PRODUCT INFORMATION**

All Robinia products are available as FSC®-certified

Product number	Product name	Age (years)	Capacity (users)	Fall height (ft & in)	Total height (ft & in)	Use zone dimensions (ft²)	Use zone dimensions (ft & in x ft & in)	Installation (hours)	Total CO <sub>2</sub> e (kg CO <sub>2</sub> e)
<b>NRO1018</b>	Play Tower with Slide & Banister Bars	5 - 12	9	6'10"	9'9"	503	29'8" x 23'11"	22	458
<b>NRO1019</b>	Play Tower with Slide	5 - 12	9	4'10"	12'4"	447	26'1" x 26'4"	21	412
<b>NRO2007</b>	Double Tower with Double Slide	2 - 5	18	4'10"	9'9"	698	33'11" x 31'6"	38	625
<b>NRO3002</b>	Robinia Cliff Rider, 8 ft H	5 - 12	21	6'11"	12'0"	732	43'3" x 26'4"	43	1,113
<b>NRO1022</b>	Track Ride Tower	5 - 12	5	6'4"	8'10"	568	34'3" x 21'8"	15	334
<b>NRO3003</b>	Robinia Cliff Rider, 8 ft H	5 - 12	25	8'6"	13'8"	790	43'7" x 27'11"	55	1,301



# ROBINIA VILLAGE



Tower with Spider Net  
NRO2006



Play Tower with Slide & Desk  
NRO1020



Play Tower with Slide & Curly Climber  
NRO1021



Multideck Tower, Monkey Bars and Desk  
NRO1024



Multideck Play Tower with Monkey Bars  
NRO1023



Mega Deck with Banister Bars  
NRO1025

## PRODUCT INFORMATION

All Robinia products are available as FSC®-certified

Product number	Product name	Age (years)	Capacity (users)	Fall height (ft & in)	Total height (ft & in)	Use zone dimensions (ft²)	Use zone dimensions (ft & in x ft & in)	Installation (hours)	Total CO <sub>2</sub> e (kg CO <sub>2</sub> e)
NRO2006	Tower with Spider Net	5 - 12	14	7'3"	14'5"	622	27'5" x 34'6"	31	663
NRO1020	Play Tower with Slide & Desk	2 - 5	9	7'3"	13'8"	450	25'7" x 24'3"	25	489
NRO1021	Play Tower with Slide & Curly Climber	5 - 12	9	7'3"	14'5"	470	25'7" x 27'0"	28	566
NRO1024	Multideck Tower, Monkey Bars and Desk	5 - 12	14	6'9"	13'8"	604	31'10" x 29'12"	33	518
NRO1023	Multideck Play Tower with Monkey Bars	5 - 12	12	6'9"	12'4"	605	26'1" x 31'6"	30	485
NRO1025	Mega Deck with Banister Bars	5 - 12	16	6'11"	13'8"	607	31'3" x 28'5"	37	536





Multideck Tower with Banister Bars  
**NRO1026**



The Witch's Tower  
**NRO2008**



Double Tower with Spider Net  
**NRO2009**



Wizard's Double Tower Fortress  
**NRO2010**



Double Tower with Turbo Challenge  
**NRO2012**



Double Tower with Valley Bridge  
**NRO3001**

**PRODUCT INFORMATION**

All Robinia products are available as FSC®-certified

Product number	Product name	Age (years)	Capacity (users)	Fall height (ft & in)	Total height (ft & in)	Use zone dimensions (ft <sup>2</sup> )	Use zone dimensions (ft & in x ft & in)	Installation (hours)	Total CO <sub>2</sub> e (kg CO <sub>2</sub> e)
<b>NRO1026</b>	Multideck Tower with Banister Bars	5 - 12	16	9'10"	16'8"	638	30'0" x 30'11"	45	833
<b>NRO2008</b>	The Witch's Tower	5 - 12	21	9'10"	17'6"	828	42'1" x 31'6"	56	993
<b>NRO2009</b>	Double Tower with Spider Net	5 - 12	27	6'10"	13'8"	811	38'12" x 34'3"	36	937
<b>NRO2010</b>	Wizard's Double Tower Fortress	5 - 12	38	8'2"	17'6"	968	33'2" x 49'9"	60	1,190
<b>NRO2012</b>	Double Tower with Turbo Challenge	5 - 12	22	7'4"	13'8"	731	32'3" x 31'12"	41	775
<b>NRO3001</b>	Double Tower with Valley Bridge	5 - 12	25	9'10"	13'8"	950	49'8" x 30'10"	59	1,178



# ROBINIA VILLAGE



Little Duck's Gate  
NRO416



Little Hen's House  
NRO417



Little Fox Shop  
NRO418

## PRODUCT INFORMATION

All Robinia products are available as FSC®-certified

Product number	Product name	Age (years)	Capacity (users)	Fall height (ft & in)	Total height (ft & in)	Use zone dimensions (ft²)	Use zone dimensions (ft & in x ft & in)	Installation (hours)	Total CO <sub>2</sub> e (kg CO <sub>2</sub> e)
NRO416	Little Duck's Gate	2 - 5	10	0'0"	9'3"	-	0'0" x 0'0"	11	96
NRO417	Little Hen's House	2 - 5	12	1'11"	9'3"	427	21'11" x 24'1"	21	200
NRO418	Little Fox Shop	2 - 5	18	1'11"	7'2"	404	20'10" x 24'4"	24	226





Little Beaver's Stream  
NRO2013



Little Turtle's Town  
NRO4001

**PRODUCT INFORMATION**

All Robinia products are available as FSC®-certified

Product number	Product name	Age (years)	Capacity (users)	Fall height (ft & in)	Total height (ft & in)	Use zone dimensions (ft²)	Use zone dimensions (ft & in x ft & in)	Installation (hours)	Total CO <sub>2</sub> e (kg CO <sub>2</sub> e)
NRO2013	Little Beaver's Stream	2 - 5	16	2'2"	9'3"	565	28'4" x 26'10"	36	477
NRO4001	Little Turtle's Town	2 - 5	26	1'11"	9'3"	763	34'0" x 29'4"	46	563



# FLEXIBILITY

With a variety of colors and part options, we offer lots of flexibility and customization with our standard products.



Color and Untreated Wood



Untreated Wood



Transparent Brown Wood

Robinia colors





# OPTIONS

## Slides and egresses



**NOTE:**  
Steel slides heated by the midday sun can cause severe skin burns. We recommend pointing steel slides away from the midday sun or using PE slides or shading.

## Extension and link



## Classic and organically shaped roofs

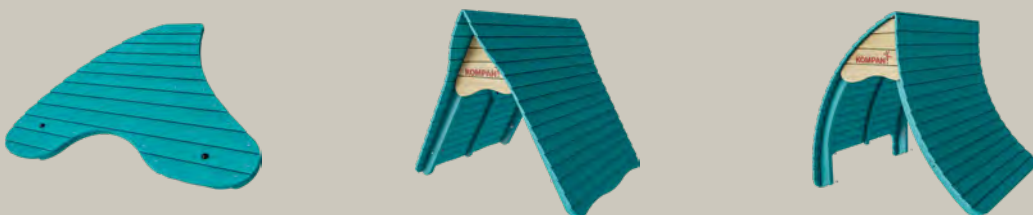

## Tall climbing wall and staircase



### More flexibility

Contact us for more information on the wide range of options for configurable playground equipment. Please note that prices and delivery terms depend on specified configurations.



# ROBINIA PLAYHOUSES

## A Cozy Play Space for the Youngest

House-themed playground equipment offers a sense of familiarity and comfort for the young. Combining the “house” concept and the incorporation of nature ignites their imagination and inspires hours of play.

In other words, Robinia Playhouses blend the benefits children get from exploring familiar concepts like “house” or “home” through play with the wonders of nature.



### For a greener future

#### Robinia wood:

Nature's own material, harvested from European forestry. Robinia wood is known for its natural preservatives that make it long lasting in the outdoors.



Playhut with Side & Desks  
NRO411



Playhut with Side  
NRO410



Playhut with Two Sides  
NRO412



Playhut with Two Sides & Desks  
NRO413



Playhut with Side, Gable & Desks  
NRO414



Playhut with Side, Gable & Desks  
NRO415

## PRODUCT INFORMATION

All Robinia products are available as FSC®-certified

Product number	Product name	Age (years)	Capacity (users)	Fall height (ft & in)	Total height (ft & in)	Use zone dimensions (ft <sup>2</sup> )	Use zone dimensions (ft & in x ft & in)	Installation (hours)	Total CO <sub>2</sub> e (kg CO <sub>2</sub> e)
NRO411	Playhut with Side & Desks	6m - 5	8	0'0"	5'2"	-	0'0" x 0'0"	5.6	36
NRO410	Playhut with Side	6m - 5	4	0'0"	5'2"	-	0'0" x 0'0"	4.4	30
NRO412	Playhut with Two Sides	6m - 5	4	0'0"	5'2"	-	0'0" x 0'0"	4.8	33
NRO413	Playhut with Two Sides & Desks	6m - 5	10	0'0"	5'2"	-	0'0" x 0'0"	6	39
NRO414	Playhut with Side, Gable & Desks	6m - 5	12	0'0"	5'2"	-	0'0" x 0'0"	6.9	45
NRO415	Playhut with Side, Gable & Desks	6m - 5	12	0'0"	5'2"	-	0'0" x 0'0"	7	46



# FLEXIBILITY

With a variety of colors and part options, we offer lots of flexibility and customization with our standard products.



Robinia colors



# OPTIONS



PRODUCT CONFIGURATOR  
[www.kompan.com](http://www.kompan.com)

## Roofs



Untreated Wood



Transparent Brown Wood

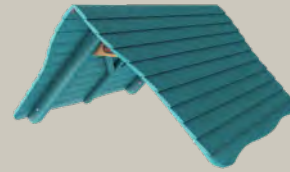

Color and Untreated Wood

## Decks

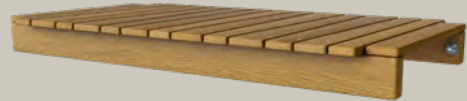

Transparent Brown Wood



Untreated Wood

## Footings



Wood in-ground



Hot-dip galvanized

## More flexibility

Contact us for more information on the wide range of options for configurable playground equipment. Please note that prices and delivery terms depend on specified configurations.



# ROBINIA CASTLES

## Captivating Castle-Themed Play

A Robinia castle-themed play structure has creative play activities on all levels and floors. Its impressive size entices children of all ages to strategize how to defend or conquer the castle, helping them develop social and cognitive creative skills.

Prepare for action and adventures suitable for queens and kings and start making your way to the castle tower.



### For a greener future

#### Robinia wood:

Nature's own material, harvested from European forestry. Robinia wood is known for its natural preservatives that make it long lasting in the outdoors.



Tall Castle, Medium  
NRO429



Castle, Small  
NRO421

Tall Castle, Small  
NRO427



Castle, Large  
NRO425



Castle, Medium  
NRO423

## PRODUCT INFORMATION

All Robinia products are available as FSC®-certified

Product number	Product name	Age (years)	Capacity (users)	Fall height (ft & in)	Total height (ft & in)	Use zone dimensions (ft <sup>2</sup> )	Use zone dimensions (ft & in x ft & in)	Installation (hours)	Total CO <sub>2</sub> e (kg CO <sub>2</sub> e)
NRO429	Tall Castle, Medium	5 - 12	60	11'9"	26'1"	1744	72'12" x 40'5"	343	-
NRO421	Castle, Small	5 - 12	26	9'10"	18'6"	676	34'5" x 28'5"	66	995
NRO427	Tall Castle, Small	5 - 12	40	11'9"	30'1"	1459	51'9" x 42'1"	96	-
NRO425	Castle, Large	5 - 12	56	9'10"	18'6"	1327	46'1" x 38'3"	120	2,136
NRO423	Castle, Medium	5 - 12	42	9'10"	18'6"	1073	37'0" x 40'7"	95	1,666





Products marked with "KDS" are tailor-made KOMPAN Design Studio solutions. Final designs and data depend on regional safety standards, and pictures are for conceptual purpose only.



Tall Castle, Large  
NRO431

**PRODUCT INFORMATION**

All Robinia products are available as FSC®-certified

Product number	Product name	Age (years)	Capacity (users)	Fall height (ft & in)	Total height (ft & in)	Use zone dimensions (ft <sup>2</sup> )	Use zone dimensions (ft & in x ft & in)	Installation (hours)	Total CO <sub>2</sub> e (kg CO <sub>2</sub> e)
NRO431	Tall Castle, Large	5 - 12	100	11'9"	34'1"	4271	83'6" x 74'12"	744	-



# ROBINIA SHIPS

## A Treasure Trove For Playful Children

Pirate-themed Robinia ships are packed with adventure-creating activities that inspire children to play and explore for hours. Themed play entices children's imaginations and encourages role-play which builds their confidence – imagine achieving a team goal when victory prevails.

If pirates have conquered your playground, it's time to get everybody on deck to guard the treasure!



### For a greener future

#### Robinia wood:

Nature's own material, harvested from European forestry. Robinia wood is known for its natural preservatives that make it long lasting in the outdoors.



52.5 FT LONG

KDS

Explorer Ship, X-Large  
NRO551



Explorer ship, Large  
NRO547



Explorer Ship, Medium  
NRO543

## PRODUCT INFORMATION

All Robinia products are available as FSC®-certified

Product number	Product name	Age (years)	Capacity (users)	Fall height (ft & in)	Total height (ft & in)	Use zone dimensions (ft²)	Use zone dimensions (ft & in x ft & in)	Installation (hours)	Total CO <sub>2</sub> e (kg CO <sub>2</sub> e)
NRO551	Explorer Ship, X-Large	5 - 12	60	9'10"	26'3"	1918	69'1" x 39'1"	93	-
NRO547	Explorer ship, Large	5 - 12	43	9'10"	22'6"	1154	38'5" x 49'12"	106	1,930
NRO543	Explorer Ship, Medium	5 - 12	38	8'10"	19'1"	953	36'6" x 43'7"	75	1,384





Products marked with “KDS” are tailor-made KOMPAN Design Studio solutions. Final designs and data depend on regional safety standards, and pictures are for conceptual purpose only.



Pirate Ship, Medium  
NRO541

52.5 FT  
LONG

KDS



Pirate Ship, X-Large  
NRO549



Pirate Ship, Large  
NRO545

## PRODUCT INFORMATION

All Robinia products are available as FSC®-certified

Product number	Product name	Age (years)	Capacity (users)	Fall height (ft & in)	Total height (ft & in)	Use zone dimensions (ft <sup>2</sup> )	Use zone dimensions (ft & in x ft & in)	Installation (hours)	Total CO <sub>2</sub> e (kg CO <sub>2</sub> e)
NRO549	Pirate Ship, X-Large	5 - 12	60	0'0"	0'0"	-	0'0" x 0'0"	93	-
NRO541	Pirate Ship, Medium	5 - 12	38	8'10"	19'1"	953	36'6" x 43'7"	75	1,395
NRO545	Pirate Ship, Large	5 - 12	43	9'10"	22'6"	1155	38'5" x 49'12"	106	1,951



# ROBINIA THEMED PLAY

## Full Speed on Imagination

Play is about preparing for life. Themed play is most forceful in stimulating youthful imaginations when mimicking reality. Themed playground equipment opens the door to adventures that would otherwise be “off-limits.”

The thrill of flying the Propeller Plane or driving the Unitruck prompts real-life scenarios, where the imagination of going from one place to another brings endless fun.



### For a greener future

#### Robinia wood:

Nature's own material, harvested from European forestry. Robinia wood is known for its natural preservatives that make it long lasting in the outdoors.



Propeller Plane  
NRO564



Unitruck  
NRO560



Short Nose Truck  
NRO561



Long Nose Truck  
NRO562



Jungle 4x4  
NRO563



Tractor  
NRO565

## PRODUCT INFORMATION

All Robinia products are available as FSC®-certified

Product number	Product name	Age (years)	Capacity (users)	Fall height (ft & in)	Total height (ft & in)	Use zone dimensions (ft <sup>2</sup> )	Use zone dimensions (ft & in x ft & in)	Installation (hours)	Total CO <sub>2</sub> e (kg CO <sub>2</sub> e)
NRO564	Propeller Plane	2 - 5	12	1'8"	4'10"	428	25'1" x 23'2"	18	307
NRO560	Unitruck	2 - 5	7	0'0"	5'3"	-	0'0" x 0'0"	17	149
NRO561	Short Nose Truck	2 - 5	8	1'11"	7'2"	406	24'11" x 18'6"	30	281
NRO562	Long Nose Truck	2 - 5	10	1'11"	8'7"	457	28'7" x 18'6"	33	331
NRO563	Jungle 4x4	2 - 5	8	0'11"	4'1"	324	17'3" x 21'4"	13	160
NRO565	Tractor	2 - 5	7	3'3"	5'10"	382	17'6" x 26'8"	16	294



# FLEXIBILITY

With a variety of colors and part options, we offer lots of flexibility and customization with our standard products.



Red



Untreated Wood



Green

Robinia colors



# OPTIONS



PRODUCT CONFIGURATOR  
www.kompan.com



Wheel tunnel  
(large trucks)

Rear slide  
(large trucks)



Sand crane  
(large trucks)

Footings



Wood in-ground



Hot-dip  
galvanized

## More flexibility

Contact us for more information on the wide range of options for configurable playground equipment. Please note that prices and delivery terms depend on specified configurations.



# ROBINIA THEMED PLAY



Forest Lake Boat  
NRO514



Gas Pump 1  
NRO511



Gas Station with 2 Pumps  
NRO513



Gas Pump 2  
NRO519



Forest Lake Boat without Floor  
NRO520

## PRODUCT INFORMATION

All Robinia products are available as FSC®-certified

Product number	Product name	Age (years)	Capacity (users)	Fall height (ft & in)	Total height (ft & in)	Use zone dimensions (ft <sup>2</sup> )	Use zone dimensions (ft & in x ft & in)	Installation (hours)	Total CO <sub>2</sub> e (kg CO <sub>2</sub> e)
NRO514	Forest Lake Boat	2 - 5	8	3'3"	8'2"	312	16'9" x 22'10"	13	115
NRO511	Gas Pump 1	2 - 5	1	0'0"	3'7"	-	0'0" x 0'0"	1.4	10
NRO513	Gas Station with 2 Pumps	2 - 5	2	0'0"	7'3"	-	0'0" x 0'0"	4.2	41
NRO519	Gas Pump 2	2 - 5	1	0'0"	3'7"	-	0'0" x 0'0"	1.4	10
NRO520	Forest Lake Boat without Floor	2 - 5	8	3'3"	8'2"	312	16'8" x 22'10"	8.7	91



# ROBINIA ACCESSORIES

## Customizable Signage

Signs are an essential way to make relevant information available for the users of private or public areas. E.g., general or practical information or instructions about the use of a playground, opening hours, ideal user or age groups, sponsors, or contact information.

Our customizable signage is flexible regarding text, signs, and symbols, enabling you to deliver the right message.



Robinia Sign Medium  
NRO217



**For a greener future**  
Post-consumer recycled materials:  
TexMade™ Posts >95%  
Steel parts adhere to industrial standards

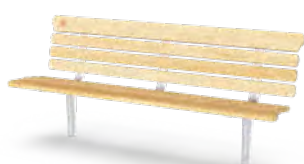

Park Bench with Backrest  
NRO213



Park Table with 2 Benches  
NRO215



Robinia Sign Large  
NRO218



Robinia Sign X-Large  
NRO219



Robinia Play Timer  
NRO216

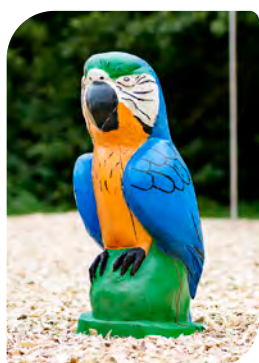

Ara Parrot Sculpture  
NRO515



Owl Sculpture  
NRO516



Iguana Sculpture, Oak  
NRO517



Lizard Sculpture, Oak  
NRO518

## PRODUCT INFORMATION

All Robinia products are available as FSC®-certified

Product number	Product name	Age (years)	Capacity (users)	Fall height (ft & in)	Total height (ft & in)	Use zone dimensions (ft²)	Use zone dimensions (ft & in x ft & in)	Installation (hours)	Total CO <sub>2</sub> e (kg CO <sub>2</sub> e)
NRO217	Robinia Sign Medium		-	0'0"	3'9"	-	0'0" x 0'0"	1.7	23
NRO213	Park Bench with Backrest		-	0'0"	2'7"	-	0'0" x 0'0"	0.8	51
NRO215	Park Table with 2 Benches		-	0'0"	2'7"	-	0'0" x 0'0"	2.2	140
NRO218	Robinia Sign Large		-	0'0"	5'1"	-	0'0" x 0'0"	2	38
NRO219	Robinia Sign X-Large		-	0'0"	7'3"	-	0'0" x 0'0"	3.1	93
NRO216	Robinia Play Timer	5 - 12	4	0'0"	4'5"	43	7'4" x 6'4"	1.3	51
NRO515	Ara Parrot Sculpture		-	0'0"	1'9"	-	0'0" x 0'0"	0.1	1
NRO516	Owl Sculpture		-	0'0"	3'4"	-	0'0" x 0'0"	0.5	5
NRO517	Iguana Sculpture, Oak		-	0'0"	1'4"	-	0'0" x 0'0"	1.4	14
NRO518	Lizard Sculpture, Oak		-	0'0"	1'2"	-	0'0" x 0'0"	1.4	14



# ROBINIA SPRINGERS

## Nothing Beats Rocking

A mother's gentle rocking is a soothing feeling. As children grow, rocking becomes a fun feeling. Rocking trains a child's sense of balance and spatial awareness – senses that help the child concentrate and navigate safely in traffic.

For younger children, rocking through their own effort or with a friend is the best feeling. Find your favorite bug-themed springer or seesaw and start buzzing.



### For a greener future

#### Robinia wood:

Nature's own material, harvested from European forestry. Robinia wood is known for its natural preservatives that make it long lasting in the outdoors.



Dolphin Springer  
NRO111



Forest Bug Springer  
NRO112



Snail Springer  
NRO115



Bee Springer  
NRO118



Forest Ant Springer  
NRO119



Mule  
NRO101



Pony  
NRO102



Spring Board  
NRO104

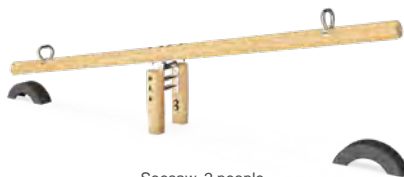

Seesaw, 2 people  
NRO105

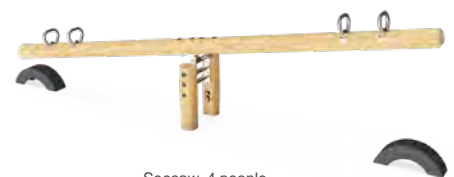

Seesaw, 4 people  
NRO106

## PRODUCT INFORMATION

All Robinia products are available as FSC®-certified

Product number	Product name	Age (years)	Capacity (users)	Fall height (ft & in)	Total height (ft & in)	Use zone dimensions (ft²)	Use zone dimensions (ft & in x ft & in)	Installation (hours)	Total CO <sub>2</sub> e (kg CO <sub>2</sub> e)
NRO111	Dolphin Springer	2 - 12	1	1'10"	2'3"	177	15'3" x 13'7"	2	70
NRO112	Forest Bug Springer	2 - 12	1	1'8"	2'3"	164	14'4" x 13'7"	1.9	69
NRO115	Snail Springer	2 - 12	1	1'8"	2'3"	167	14'6" x 13'7"	2.2	82
NRO118	Bee Springer	2 - 12	1	1'10"	2'5"	165	14'6" x 13'7"	1.9	84
NRO119	Forest Ant Springer	2 - 12	1	1'10"	2'5"	165	14'6" x 13'7"	1.9	84
NRO101	Mule	2 - 12	1	1'12"	2'2"	152	12'8" x 14'5"	2.1	61
NRO102	Pony	2 - 12	1	1'12"	2'4"	154	12'8" x 14'6"	2.1	60
NRO104	Spring Board	2 - 12	3	1'6"	1'6"	170	14'9" x 14'6"	2.9	164
NRO105	Seesaw, 2 people	5 - 12	2	3'9"	3'9"	292	25'10" x 13'8"	3.7	65
NRO106	Seesaw, 4 people	5 - 12	6	3'9"	3'9"	277	25'2" x 13'7"	3.7	72



# ROBINIA DYNAMICS

## Vital Tummy-Tickling Play Activities

The Robinia Dynamics portfolio entices children of all ages and abilities to come and experience the thrilling feeling of sliding, spinning, or swinging. Children need the sensation of butterflies in their stomach from spinning, sliding, and swinging to help their nervous system mature and organize.

Spinning, sliding, and swinging are vital in child development – the best part is that children love it!



### For a greener future

#### Robinia wood:

Nature's own material, harvested from European forestry. Robinia wood is known for its natural preservatives that make it long lasting in the outdoors.



Carousel with Seats  
NRO120



Spinner Plate  
NRO110



Turbo Challenge  
NRO884



Spinner Bowl  
ELE400024



Tipi Carousel w/ Top Brace  
ELE400065



Tipi Carousel  
ELE400064



Supernova  
GXY960



## PRODUCT INFORMATION

All Robinia products are available as FSC®-certified

Product number	Product name	Age (years)	Capacity (users)	Fall height (ft & in)	Total height (ft & in)	Use zone dimensions (ft²)	Use zone dimensions (ft & in x ft & in)	Installation (hours)	Total CO <sub>2</sub> e (kg CO <sub>2</sub> e)
NRO120	Carousel with Seats	5 - 12	8	2'8"	2'8"	420	23'1" x 23'1"	3	336
NRO110	Spinner Plate	5 - 12	1	1'7"	1'7"	146	13'7" x 13'8"	1.6	52
NRO884	Turbo Challenge	5 - 12	4	6'7"	8'8"	323	20'10" x 16'11"	8.9	131
ELE400024	Spinner Bowl	5 - 12	1	1'12"	1'12"	149	13'9" x 13'9"	1.2	55
ELE400065	Tipi Carousel w/ Top Brace	5 - 12	8	3'3"	4'0"	380	21'12" x 21'12"	2.5	232
ELE400064	Tipi Carousel	5 - 12	6	1'9"	1'9"	380	21'12" x 21'12"	2.5	209
GXY960	Supernova	5 - 12	8	2'4"	2'4"	484	24'10" x 24'10"	3	428



# ROBINIA ZIPLINES

## The King of Fun, Thrill, and Action

The line for the cableway is always long! Whether you're four or twelve, cableways are incredibly fun and exciting. Cableways teach children several essential skills. Through interaction with each other when playing on the cableway, they learn to wait their turn and hand over the seat to the next in line.

A cableway is a thrilling playground asset that unites generations, abilities, and playful minds alike.



Zipline Start Platform  
NRO879



### For a greener future

#### Robinia wood:

Nature's own material, harvested from European forestry. Robinia wood is known for its natural preservatives that make it long lasting in the outdoors.



Double Zipline, Flat Space  
NRO883



## PRODUCT INFORMATION

All Robinia products are available as FSC®-certified

Product number	Product name	Age (years)	Capacity (users)	Fall height (ft & in)	Total height (ft & in)	Use zone dimensions (ft²)	Use zone dimensions (ft & in x ft & in)	Installation (hours)	Total CO <sub>2</sub> e (kg CO <sub>2</sub> e)
NRO879	Zipline Start Platform	5 - 12	-	2'11"	7'5"	348	16'9" x 23'5"	10	84
NRO883	Double Zipline, Flat Space	5 - 12	2	6'11"	13'0"	2691	123'5" x 30'8"	21	1,110





Zipline, Sloped Space  
NRO875



Zipline, Flat Space  
NRO877



Double Zipline, Sloped Space  
NRO881

## PRODUCT INFORMATION

All Robinia products are available as FSC®-certified

Product number	Product name	Age (years)	Capacity (users)	Fall height (ft & in)	Total height (ft & in)	Use zone dimensions (ft²)	Use zone dimensions (ft & in x ft & in)	Installation (hours)	Total CO <sub>2</sub> e (kg CO <sub>2</sub> e)
NRO875	Zipline, Sloped Space	5 - 12	1	6'11"	9'9"	1788	122'3" x 22'2"	12	579
NRO877	Zipline, Flat Space	5 - 12	1	6'11"	12'12"	1826	122'3" x 24'1"	9.9	617
NRO881	Double Zipline, Sloped Space	5 - 12	2	6'11"	9'9"	2650	123'5" x 28'10"	20	1,061



# ROBINIA OBSTACLE COURSES

## Climbing Challenge - Bring it On!

A Robinia climbing trail is a challenge that children of all ages and abilities will want to take on. Whether playing “the ground is lava” or other creative games, children train their balance and social-emotional skills and practice essential life skills without noticing.

Balancing, swaying, and climb-and-crawl activities are immense fun and the accompanying challenge is embraced with enthusiasm!



### For a greener future

#### Robinia wood:

Nature's own material, harvested from European forestry. Robinia wood is known for its natural preservatives that make it long lasting in the outdoors.



Waterlilies Balance Posts - 5 pcs  
NRO820



Balance posts with rope  
NRO832



Parkour 1  
NRO856



Parkour 4  
NRO854



Parkour 5  
NRO857

## PRODUCT INFORMATION

All Robinia products are available as FSC®-certified

Product number	Product name	Age (years)	Capacity (users)	Fall height (ft & in)	Total height (ft & in)	Use zone dimensions (ft²)	Use zone dimensions (ft & in x ft & in)	Installation (hours)	Total CO <sub>2</sub> e (kg CO <sub>2</sub> e)
NRO820	Waterlilies Balance Posts - 5 pcs	2 - 12	2	1'1"	1'1"	237	19'2" x 15'6"	2.2	16
NRO832	Balance posts with rope	5 - 12	3	3'11"	3'11"	278	22'5" x 15'9"	4	34
NRO856	Parkour 1	5 - 12	4	5'7"	5'7"	352	26'11" x 20'1"	5	37
NRO854	Parkour 4	5 - 12	12	8'11"	8'11"	759	27'3" x 44'9"	11	302
NRO857	Parkour 5	5 - 12	33	8'11"	8'11"	1662	55'3" x 52'4"	29	515



# ROBINIA BALANCING

## Down-to-Earth Learning

Once children embark on a balancing trail, they develop essential life skills without noticing. Balancing helps train their eyesight and ability to concentrate. Two fundamental skills that both improve children's readiness for school and performance when going to school.

Watch out for crocodiles in the lagoon or get ready for a thrilling game of "the ground is lava."



### For a greener future

#### Robinia wood:

Nature's own material, harvested from European forestry. Robinia wood is known for its natural preservatives that make it long lasting in the outdoors.



Stilts  
NRO806



Single Balance Beam  
NRO887



Double Balance Beam  
NRO888



Triple Balance Beam  
NRO889



Wobble Bridge  
NRO810



Dynamic Bar  
NRO830



Rope Bridge  
NRO811



Meeting Post  
NRO805



Sitting Pole, Natural  
NRO209



Double Somersault  
NRO808



Triple Somersault  
NRO809

## PRODUCT INFORMATION

All Robinia products are available as FSC®-certified

Product number	Product name	Age (years)	Capacity (users)	Fall height (ft & in)	Total height (ft & in)	Use zone dimensions (ft <sup>2</sup> )	Use zone dimensions (ft & in x ft & in)	Installation (hours)	Total CO <sub>2</sub> e (kg CO <sub>2</sub> e)
NRO806	Stilts	5 - 12	3	3'7"	3'7"	286	16'1" x 20'2"	3.4	20
NRO887	Single Balance Beam	5 - 12	2	1'3"	1'3"	248	22'2" x 12'6"	2.3	10
NRO888	Double Balance Beam	5 - 12	4	1'3"	1'3"	356	28'1" x 19'7"	3.3	18
NRO889	Triple Balance Beam	5 - 12	6	1'3"	1'3"	465	36'8" x 19'7"	4.4	26
NRO810	Wobble Bridge	5 - 12	3	1'5"	4'7"	364	24'6" x 16'1"	6.7	87
NRO830	Dynamic Bar	5 - 12	1	1'5"	4'9"	209	18'12" x 12'8"	2.8	26
NRO811	Rope Bridge	5 - 12	2	8'6"	8'6"	215	19'4" x 13'9"	3.6	28
NRO805	Meeting Post	2 - 12	1	0'0"	2'7"	-	0'0" x 0'0"	1.2	4
NRO209	Sitting Pole, Natural	6m - 5	1	0'0"	0'12"	-	0'0" x 0'0"	0.9	2
NRO808	Double Somersault	5 - 12	2	3'8"	4'11"	213	19'4" x 14'3"	2.8	31
NRO809	Triple Somersault	5 - 12	3	3'8"	4'11"	258	22'12" x 14'3"	3.5	45



# ROBINIA CLIMBING

## Challenging Climbing Structures

Remember the sense of achievement when conquering the giant tree in your neighborhood? Robinia climbing structures create that same wonderful experience! Making their path to the top, children cultivate self-confidence and develop cross-coordination skills that contribute to their reading development.

Children love to climb trees. Not because it's easy but because it's challenging.



### For a greener future

#### Robinia wood:

Nature's own material, harvested from European forestry. Robinia wood is known for its natural preservatives that make it long lasting in the outdoors.

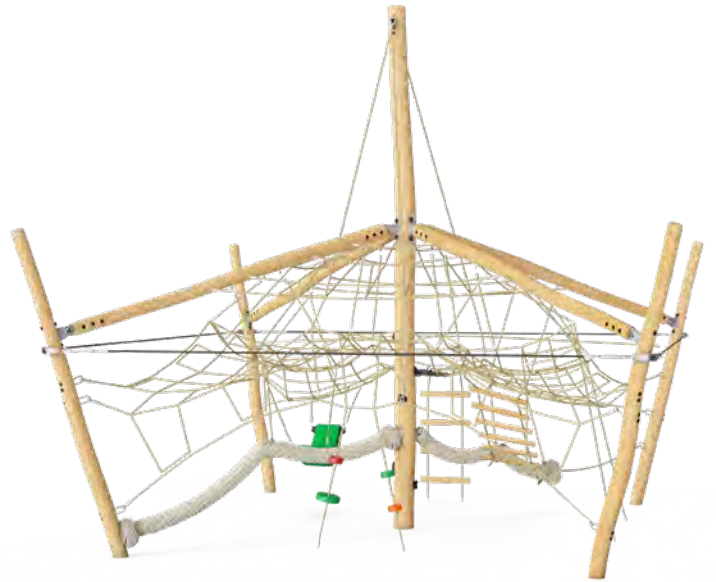

Jungle Dome  
NRO836



Hammock  
NRO815



Balance poles  
NRO817



Climbing net  
NRO813



Crawling Pyramid  
NRO826



Balance Net  
NRO831



Double Web Climber  
NRO833

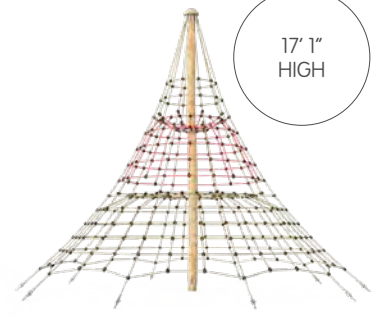

Tree Climber  
NRO834

17' 1" HIGH

## PRODUCT INFORMATION

All Robinia products are available as FSC®-certified

Product number	Product name	Age (years)	Capacity (users)	Fall height (ft & in)	Total height (ft & in)	Use zone dimensions (ft <sup>2</sup> )	Use zone dimensions (ft & in x ft & in)	Installation (hours)	Total CO <sub>2</sub> e (kg CO <sub>2</sub> e)
NRO836	Jungle Dome	5 - 12	50	7'10"	19'7"	1026	33'5" x 33'5"	44	1,748
NRO815	Hammock	5 - 12	2	4'2"	5'5"	294	25'0" x 14'6"	2.8	117
NRO817	Balance poles	5 - 12	2	8'6"	8'6"	219	19'6" x 13'8"	4.6	88
NRO813	Climbing net	5 - 12	7	8'6"	8'6"	390	22'2" x 20'10"	6.4	152
NRO826	Crawling Pyramid	5 - 12	6	2'4"	4'11"	538	25'1" x 25'4"	8.7	95
NRO831	Balance Net	5 - 12	3	3'3"	3'3"	314	21'5" x 16'2"	4.4	69
NRO833	Double Web Climber	5 - 12	6	6'0"	6'0"	300	18'10" x 19'11"	4.3	139
NRO834	Tree Climber	5 - 12	34	6'0"	17'1"	872	33'4" x 33'4"	13	912





## PRODUCT INFORMATION

All Robinia products are available as FSC®-certified

Product number	Product name	Age (years)	Capacity (users)	Fall height (ft & in)	Total height (ft & in)	Use zone dimensions (ft²)	Use zone dimensions (ft & in x ft & in)	Installation (hours)	Total CO <sub>2</sub> e (kg CO <sub>2</sub> e)
NRO816	Six-sided climbing structure	5 - 12	20	9'2"	9'6"	659	30'10" x 26'2"	21	462
NRO852	Parkour 2	5 - 12	14	8'9"	9'2"	364	22'10" x 22'5"	8.4	234



# ROBINIA PLAY, ACT & LEARN

## Add New Dimensions to Play

The Robinia Play, Act, & Learn range offers sensory, ground-based creative play for the youngest children. As an ultimate play starter, this range takes children through a creative play world with activities stimulating their cognitive and social skills.

Whether on the stage, drawing on the chalkboard, or playing on the music panels, the rhythm of play resonates with joy.



### For a greener future

#### Robinia wood:

Nature's own material, harvested from European forestry. Robinia wood is known for its natural preservatives that make it long lasting in the outdoors.



Theater & Music Cottage  
NRO606



Dress-Up Wall with Mirror  
NRO603



Theater Stage  
NRO604



Dress-Up Cottage  
NRO605



Play & Learn Blackboard  
NRO610



Play & Learn College  
NRO611

## PRODUCT INFORMATION

All Robinia products are available as FSC®-certified

Product number	Product name	Age (years)	Capacity (users)	Fall height (ft & in)	Total height (ft & in)	Use zone dimensions (ft <sup>2</sup> )	Use zone dimensions (ft & in x ft & in)	Installation (hours)	Total CO <sub>2</sub> e (kg CO <sub>2</sub> e)
NRO606	Theater & Music Cottage	2 - 5	15	0'0"	8'5"	-	0'0" x 0'0"	15	199
NRO603	Dress-Up Wall with Mirror	2 - 5	6	0'0"	4'11"	-	0'0" x 0'0"	5.5	36
NRO604	Theater Stage	2 - 5	6	0'11"	5'6"	320	21'1" x 16'9"	7.8	71
NRO605	Dress-Up Cottage	2 - 5	8	0'0"	8'5"	-	0'0" x 0'0"	12	111
NRO610	Play & Learn Blackboard	2 - 12	6	0'0"	5'10"	-	0'0" x 0'0"	5.4	103
NRO611	Play & Learn College	2 - 12	10	0'0"	5'10"	-	0'0" x 0'0"	7.1	118



# ROBINIA PLAY PANELS

## That Little Extra Fun for Play and Learning

Play panels for the youngest add a learning dimension to play as the panels help guide the child's learning towards specific topics. Children learn by drawing on the chalkboards and playing together on the music panels.

Watch them blossom as their skill set grows when participating in creative play with friends, caregivers, or independently.

PRODUCT CONFIGURATOR  
www.kompan.com

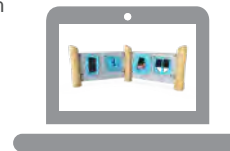

PLAY PANEL  
OPTIONS  
PAGE 165



### For a greener future

#### Robinia wood:

Nature's own material, harvested from European forestry. Robinia wood is known for its natural preservatives that make it long lasting in the outdoors.



Music Play Panel 1  
NRO612



Music Play Panel 2  
NRO613



Emotion Play Panel 2  
NRO614



Learning Play Panel 3  
NRO615

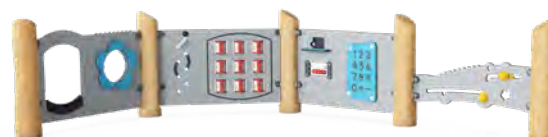

School Play Panel 4  
NRO616



Kids Table with 4 Sitting Poles  
NRO212



Percussion Music Panel  
NRO602



## PRODUCT INFORMATION

All Robinia products are available as FSC®-certified

Product number	Product name	Age (years)	Capacity (users)	Fall height (ft & in)	Total height (ft & in)	Use zone dimensions (ft²)	Use zone dimensions (ft & in x ft & in)	Installation (hours)	Total CO <sub>2</sub> e (kg CO <sub>2</sub> e)
NRO612	Music Play Panel 1	6m - 5	4	0'0"	2'9"	-	0'0" x 0'0"	2.6	64
NRO613	Music Play Panel 2	6m - 5	6	0'0"	2'9"	-	0'0" x 0'0"	4.8	92
NRO614	Emotion Play Panel 2	6m - 5	8	0'0"	2'9"	-	0'0" x 0'0"	5.9	50
NRO615	Learning Play Panel 3	6m - 5	10	0'0"	2'9"	-	0'0" x 0'0"	7	69
NRO616	School Play Panel 4	6m - 5	14	0'0"	2'9"	-	0'0" x 0'0"	8	105
NRO212	Kids Table with 4 Sitting Poles	6m - 5	4	0'0"	1'8"	-	0'0" x 0'0"	2.2	11
NRO602	Percussion Music Panel	2 - 5	3	0'0"	2'7"	-	0'0" x 0'0"	3.7	31



# ROBINIA SAND & WATER PLAY

## Fun, Sensory, and Messy Play

We all know the sensory feeling of sand running through our fingers. Why? Because we've done it so many times as children. Constructing things in the sand gives children a sense of success. It stimulates their creativity while learning to take turns and observe how their peers' imaginations unfold.

Sand play is messy but so much fun! So kids, pull up your sleeves and start mixing sand and water.



### For a greener future Robinia wood:

Nature's own material, harvested from European forestry. Robinia wood is known for its natural preservatives that make it long lasting in the outdoors.



Oasis Sand House with Desk & Crane  
**NRO528**



Toddler Oasis with Sand Desk  
**NRO523**



Oasis Sand Hut with Two Tables  
**NRO526**



Water Seesaw  
**NRO504**



Water Channel  
**NRO505**

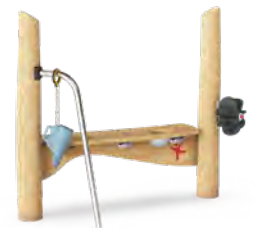

Sand Desk  
**NRO510**

## PRODUCT INFORMATION

All Robinia products are available as FSC®-certified

Product number	Product name	Age (years)	Capacity (users)	Fall height (ft & in)	Total height (ft & in)	Use zone dimensions (ft²)	Use zone dimensions (ft & in x ft & in)	Installation (hours)	Total CO <sub>2</sub> e (kg CO <sub>2</sub> e)
<b>NRO528</b>	Oasis Sand House with Desk & Crane	2 - 5	17	1'7"	9'5"	363	18'8" x 23'5"	21	299
<b>NRO523</b>	Toddler Oasis with Sand Desk	6m - 5	6	0'11"	6'11"	318	20'2" x 18'6"	9.1	122
<b>NRO526</b>	Oasis Sand Hut with Two Tables	2 - 5	5	0'0"	8'2"	-	0'0" x 0'0"	7.2	131
<b>NRO504</b>	Water Seesaw	2 - 5	2	0'0"	2'10"	-	0'0" x 0'0"	2.4	19
<b>NRO505</b>	Water Channel	2 - 5	2	0'0"	2'7"	-	0'0" x 0'0"	2.3	11
<b>NRO510</b>	Sand Desk	2 - 5	5	0'0"	4'4"	-	0'0" x 0'0"	3.6	55





Oasis Sandworks  
NRO533



Oasis Creator  
NRO534



Oasis Gravel Pit  
NRO535

## PRODUCT INFORMATION

All Robinia products are available as FSC®-certified

Product number	Product name	Age (years)	Capacity (users)	Fall height (ft & in)	Total height (ft & in)	Use zone dimensions (ft²)	Use zone dimensions (ft & in x ft & in)	Installation (hours)	Total CO <sub>2</sub> e (kg CO <sub>2</sub> e)
NRO533	Oasis Sandworks	2 - 5	12	1'7"	9'9"	319	22'10" x 17'9"	13	230
NRO534	Oasis Creator	2 - 5	16	2'11"	11'1"	407	20'10" x 23'4"	21	300
NRO535	Oasis Gravel Pit	2 - 5	25	2'11"	11'1"	485	26'8" x 22'8"	28	469



# ROBINIA SAND & WATER PLAY



Oasis Sand Boat with Sail  
NRO529



Sand Pit, 7ft  
NRO501



Edging, per 7ft  
NRO502



Sand Pit, 3ft  
NRO503



Square Edging 6  
NRO521



Splash Table  
NRO506



Water Tap Podium  
NRO507



Water Channel with Splash Table  
NRO508



Water Seesaw with 2 Splash Tables  
NRO509

## PRODUCT INFORMATION

All Robinia products are available as FSC®-certified

Product number	Product name	Age (years)	Capacity (users)	Fall height (ft & in)	Total height (ft & in)	Use zone dimensions (ft²)	Use zone dimensions (ft & in x ft & in)	Installation (hours)	Total CO <sub>2</sub> e (kg CO <sub>2</sub> e)
NRO529	Oasis Sand Boat with Sail	2 - 5	10	3'3"	11'6"	382	16'8" x 27'1"	12	134
NRO501	Sand Pit, 7ft	2 - 5	-	0'0"	0'11"	-	0'0" x 0'0"	2	9
NRO502	Edging, per 7ft	2 - 5	-	0'0"	0'6"	-	0'0" x 0'0"	1.2	4
NRO503	Sand Pit, 3ft	2 - 5	8	0'0"	0'11"	-	0'0" x 0'0"	1.5	4
NRO521	Square Edging 6	2 - 5	-	0'0"	0'6"	-	0'0" x 0'0"	0.4	3
NRO506	Splash Table	2 - 5	8	0'0"	2'0"	-	0'0" x 0'0"	2.7	80
NRO507	Water Tap Podium	2 - 5	2	0'7"	0'7"	172	14'4" x 14'4"	2	10
NRO508	Water Channel with Splash Table	2 - 5	13	1'9"	3'6"	313	16'6" x 22'5"	5.5	146
NRO509	Water Seesaw with 2 Splash Tables	2 - 5	21	1'9"	3'6"	370	16'6" x 25'3"	7.5	235





Water Tap  
M59305



Excavator  
NRO524



## PRODUCT INFORMATION

All Robinia products are available as FSC®-certified

Product number	Product name	Age (years)	Capacity (users)	Fall height (ft & in)	Total height (ft & in)	Use zone dimensions (ft²)	Use zone dimensions (ft & in x ft & in)	Installation (hours)	Total CO <sub>2</sub> e (kg CO <sub>2</sub> e)
M59305	Water Tap	2 - 5	1	0'0"	3'6"	-	0'0" x 0'0"	1.3	49
NRO524	Excavator	2 - 5	1	1'3"	2'7"	264	18'4" x 18'4"	1.5	251



# ROBINIA SWINGS

## Swinging – A Natural Joy

Of all play activities, swinging is a favorite. Swinging trains children's balance and coordination as well as their spatial awareness. These motor skills are crucial for judging distances, navigating traffic safely, and sitting still in school. Children also love to swing!

Whether it's a quiet moment swinging alone or wild play with friends on the Birds Nest swing, the sensation of swinging is unparalleled.

See options on the FLEXIBILITY page.



### For a greener future

#### Robinia wood:

Nature's own material, harvested from European forestry. Robinia wood is known for its natural preservatives that make it long lasting in the outdoors.



Birds Nest Swing  
NRO911



Robinia Flower Swing  
NRO916



Two Seat Swing  
NRO910



Double Swing Combination  
NRO912



Cocowave Rope Pendulum Swing  
NRO915

## PRODUCT INFORMATION

All Robinia products are available as FSC®-certified

Product number	Product name	Age (years)	Capacity (users)	Fall height (ft & in)	Total height (ft & in)	Use zone dimensions (ft <sup>2</sup> )	Use zone dimensions (ft & in x ft & in)	Installation (hours)	Total CO <sub>2</sub> e (kg CO <sub>2</sub> e)
NRO911	Birds Nest Swing	2 - 12	7	7'7"	9'4"	544	25'6" x 30'10"	6.5	217
NRO916	Robinia Flower Swing	6m - 2	1	2'7"	5'8"	86	9'10" x 15'7"	2.6	36
NRO910	Two Seat Swing	2 - 12	2	7'9"	9'4"	606	27'5" x 30'12"	6.4	101
NRO912	Double Swing Combination	2 - 12	9	7'9"	9'4"	915	37'12" x 30'12"	10	301
NRO915	Cocowave Rope Pendulum Swing	5 - 12	8	10'10"	12'9"	732	39'9" x 22'9"	14	535





SEAT OPTIONS  
PAGE 174



Swing Frame, 1 seat  
**NRO921**



Swing Frame, 2 seats  
**NRO922**



Swing Frame, 3 seats  
**NRO923**



Swing Frame, 4 seats  
**NRO924**



Swing Frame, 5 seats  
**NRO925**



Swing Frame, 6 seats  
**NRO926**

## PRODUCT INFORMATION

All Robinia products are available as FSC®-certified

Product number	Product name	Age (years)	Capacity (users)	Fall height (ft & in)	Total height (ft & in)	Use zone dimensions (ft <sup>2</sup> )	Use zone dimensions (ft & in x ft & in)	Installation (hours)	Total CO <sub>2</sub> e (kg CO <sub>2</sub> e)
<b>NRO921</b>	Swing Frame, 1 seat	2 - 12	-	0'0"	9'6"	398	22'9" x 19'2"	5.6	49
<b>NRO922</b>	Swing Frame, 2 seats	2 - 12	-	0'0"	9'6"	484	26'12" x 19'2"	6	57
<b>NRO923</b>	Swing Frame, 3 seats	2 - 12	-	0'0"	9'6"	635	35'0" x 19'2"	8.8	90
<b>NRO924</b>	Swing Frame, 4 seats	2 - 12	-	0'0"	9'6"	715	39'3" x 19'2"	9.2	99
<b>NRO925</b>	Swing Frame, 5 seats	2 - 12	-	0'0"	9'6"	872	47'4" x 19'2"	12	131
<b>NRO926</b>	Swing Frame, 6 seats	2 - 12	-	0'0"	9'6"	953	51'7" x 19'2"	12	140



# FLEXIBILITY

With a variety of colors and part options, we offer lots of flexibility and customization with our standard products.



Color and Untreated Wood



Untreated Wood



Transparent Brown Wood

Robinia colors





# OPTIONS



PRODUCT CONFIGURATOR  
www.kompan.com



## Bird Nest swing seats



## Swing seats



Baby



Toddler



All ages



You & Me



Duo



Inclusive



## Footings



Wood  
in-ground



Steel  
in-ground



Steel  
surface

## More flexibility

Contact us for more information on the wide range of options for configurable playground equipment. Please note that prices and delivery terms depend on specified configurations.







# OUTDOOR FITNESS





# CIRCUIT TRAINING

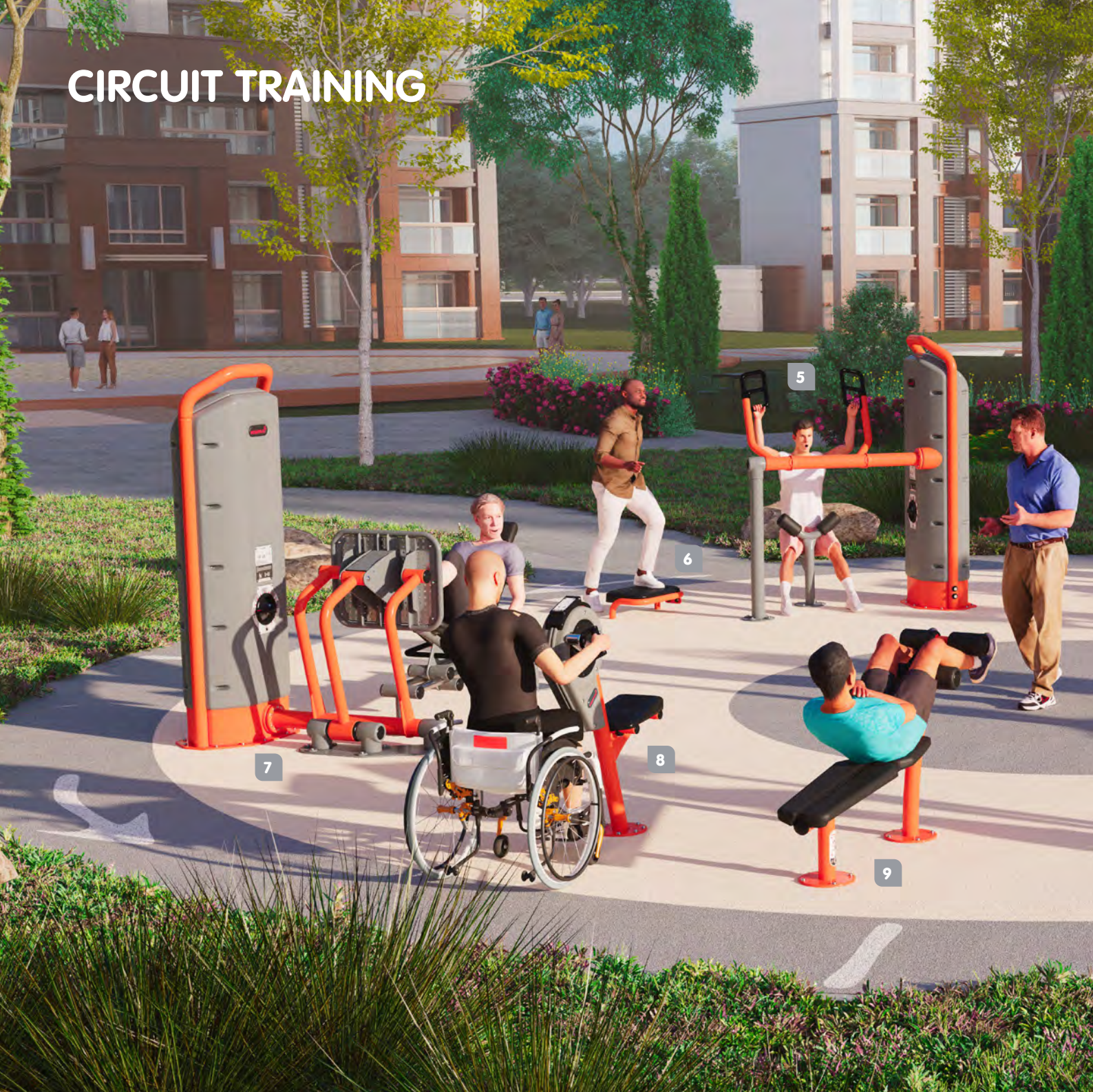

## FITNESS SOLUTION

Circuit Training is a compact and efficient training area with cardio and strength equipment. This outdoor circuit includes some of the most popular indoor cardio and strength machines, which will ensure the user an effective full-body workout. The machines are adjustable, so they fit the user's fitness level.

The machines are easy to use and resistant to wear and tear, which makes the site perfect for communities and parks. A timer is placed in the middle of the circle, making it suitable for interval training or other timed workouts.





See more solutions  
on [kompan.com](https://www.kompan.com)

Minor regional deviations can occur due to differences in safety standards

## PRODUCT INFORMATION

Product number	Product name	Product number	Product name
1	FAZ601 Chest Press Pro	7	FAZ603 Leg Press Pro
2	FAZ52101 Cross Trainer Pro Touchscreen	8	FAZ51100 Arm Bike Pro
3	FAZ607 Lower Back Bench Pro	9	FAZ606 Sit Up Bench Pro
4	FAZ50101 City Bike Pro Touchscreen	10	FAZ50101 City Bike Pro Touchscreen
5	FAZ602 Pull Down Pro	11	FSW301 Multi Timer
6	FAZ30100 Step, 8 in		



# FIT FOR ALL



## FITNESS SOLUTION

This site is created based on the principles of universal design. The site works equally well for disabled, elderly, untrained, and fit people. While not every item may suit everyone, anyone can discover items that are valuable to them, making the site inclusive and accessible. The strength machines can be used directly from a wheelchair or with easy transfer from one. The different cardio options ensure

that there is something for all and the equipment use zones guarantee ample space to move and maneuver around. The equipment is color-coded with bright colors to make the different workout zones easy to recognize. This makes the site welcoming for everyone.





See more solutions  
on [kompan.com](http://kompan.com)

Minor regional deviations can occur due to differences in safety standards

## PRODUCT INFORMATION

Product number	Product name	Product number	Product name
1	FAZ605 Horizontal Row Pro	10	FSW226 Flex Wheel
2	FAZ603 Leg Press Pro	11	FSW222 Assisted Step
3	FAZ602 Pull Down Pro	12	FSW229 Stairs & Ramp
4	FAZ604 Shoulder Press Pro	13	FSW209 Push Up Bars
5	FAZ601 Chest Press Pro	14	FAZ607 Lower Back Bench Pro
6	FAZ50101 City Bike Pro Touchscreen	15	FAZ606 Sit Up Bench Pro
7	FAZ51100 Arm Bike Pro	16	FSW201 Parallel Bars
8	FAZ52101 Cross Trainer Pro Touchscreen	17	FSW223 Stretch Station
9	FSW228 Up & Go	18	FAZ20401 Cross Training Pro Combi 3









See more solutions  
on [kompan.com](https://www.kompan.com)

Minor regional deviations can occur due to differences in safety standards

## PRODUCT INFORMATION

Product number	Product name	Product number	Product name
1	PAR4163 Agora Steel Hangout Bench	7	FSW215 Balance Beam
2	FSW21201 Double Turbo Challenge	8	FSW219 Combi Steps
3	FSW221 Jump Pod Set	9	FSW218 Square Pull-Up Station
4	FSW214 Over Under	10	PAR4150 Agora Steel Bench
5	FSW213 Double Overhead Ladder	11	FSW211 Hurdles
6	PAR3001 Bicycle Stand	12	FSW216 Vertical Net and Wall



# STAY FIT



## FITNESS SOLUTION

As we advance in life, physical mobility is vital for us. To avoid becoming restricted, we need to keep our bodies mobile and our minds healthy. This solution is designed to promote active and healthy aging and to make injury rehabilitation available outdoors in the public space.

The beautiful garden invites everyone to join in and be active at their own level. It's easy to do with adjustable strength and cardio equipment, ensuring easy maintenance and development of endurance and strength. Falling is a serious concern for older people.

Accidents often occur because the person is unable to overcome or react to minor changes in the surface they walk on. By using fitness equipment on a daily basis, older adults can improve their balance, endurance, strength, and flexibility – and ultimately, lower their risk of falling.





See more solutions  
on [kompan.com](https://www.kompan.com)

Minor regional deviations can occur due to differences in safety standards

## PRODUCT INFORMATION

Product number	Product name	Product number	Product name
1	FSW225 Surface Challenge 5	8	FSW227 Balance Station
2	FSW230 Double Stairs	9	FSW223 Stretch Station
3	FAZ51100 Arm Bike Pro	10	FAZ603 Leg Press Pro
4	FAZ50101 City Bike Pro Touchscreen	11	FAZ605 Horizontal Row Pro
5	FSW222 Assisted Step	12	FAZ601 Chest Press Pro
6	FSW228 Up & Go	13	PAR4054 Agora Steel Bench with Backrest
7	FSW231 Balance Board		



# ROOFTOP GYM



## FITNESS SOLUTION

On the rooftop, this gym has created the perfect extension of their indoor offering! A space that allows their members to do a full workout routine while enjoying the outdoors, benefitting from all the positive effects on their health and wellbeing.

By using a similar layout to the indoor area and creating different workout areas, it's easy for the members to move around and find the activities they prefer.

The great thing about this training space is that it can just as easily be created in a public park, as all the equipment is certified for usage in unsupervised and public areas.





See more solutions  
on [kompan.com](http://kompan.com)

Minor regional deviations can occur due to differences in safety standards

## PRODUCT INFORMATION

Product number	Product name	Product number	Product name
1	FAZ605 Horizontal Row Pro	9	FAZ105 Core Twist Pro
2	FAZ601 Chest Press Pro	10	FAZ102 Magnetic Bells Pro
3	FAZ603 Leg Press Pro	11	FSW201 Parallel Bars
4	FAZ604 Shoulder Press Pro	12	FAZ10101 Suspension Trainer Pro
5	FAZ602 Pull Down Pro	13	FAZ50201 Sport Bike Pro Touchscreen
6	FAZ607 Lower Back Bench Pro	14	FAZ52101 Cross Trainer Pro Touchscreen
7	FAZ606 Sit Up Bench Pro	15	FST930 Bootcamp Base
8	FAZ30300 Step, 24 in	16	FAZ30200 Step, 16 in



# ACTIVE BOARDWALK



## FITNESS SOLUTION

The elegant curved structures fit perfectly into any environment, be it boulevards, promenades, parks, or on top of a skyscraper. This solution requires little safety surfacing and can blend into any natural setting. The exclusive design and organic shapes invite and attract people to come and exercise. Additionally, the fact that there is something for everyone makes it motivating for users of all ages and abilities.

The bikes motivate people who are out for a stroll to sit down and get started! While they are enjoying the view, they can get their daily

dose of cardio training. Strength can be improved by using the magnetic bells, starting with low weights for beginners and heavier weights when looking for a challenge. The training value is huge, and countless exercise variations can be made. It's a perfect solution for a small space with extra large ambitions. Big enough for a complete sports team or a school class, this solution will fit anywhere.





5

See more solutions  
on [kompan.com](http://kompan.com)

Minor regional deviations can occur due to differences in safety standards

## PRODUCT INFORMATION

Product number	Product name
1 FAZ50101	City Bike Pro Touchscreen
2 FAZ52101	Cross Trainer Pro Touchscreen
3 FAZ30300	Step, 24 in
4 FAZ30200	Step, 16 in
5 FAZ20101	Cross Training Pro Combi 1



# PLAY & TRAIN



## FITNESS SOLUTION

The combination of play and fitness equipment allows parents to work out while their children enjoy the playground. Parents can be active role models, inspiring their children to live a healthy and active life throughout their childhood and become active adults. The wooden fitness equipment fits perfectly with the surrounding nature and offers a variety of different workouts for adults.

Working out for children is done through play, and with this playground, they improve their muscle strength on the BLOQX, develop a good balance when spinning on the Supernova, and train their endurance when playing in the Giant towers. This site will help provide an active lifestyle for children and adults alike.





See more solutions  
on [kompan.com](http://kompan.com)

Minor regional deviations can occur due to differences in safety standards

## PRODUCT INFORMATION

Product number	Product name	Product number	Product name
1	FRO104 Combi 4 Robinia	9	FAZ30100 Step, 8 in
2	FRO202 Dip Bench Robinia	10	FAZ30200 Step, 16 in
3	FRO201 Parallel Bars Robinia	11	FAZ30300 Step, 24 in
4	FRO218 Square Pull Up Station Robinia	12	BLX4104 BLOQX 4
5	FRO222 Multi Timer Robinia	13	GXY960 Supernova
6	FAZ51100 Arm Bike Pro	14	PAR4050 Agora Bench
7	FAZ50101 City Bike Pro Touchscreen	15	Customized Giant
8	FAZ52101 Cross Trainer Pro Touchscreen		



# ACTIVE TEENAGERS



## FITNESS SOLUTION

The active teenagers' fitness site is based on knowledge about the preferences of this age group. We know that fitness training is one of their preferred activities and that teenagers like to be social and have fun. This site perfectly combines cardio and strength equipment with a game arena and challenging street workout. Another great thing about this mix is that there is something to do for all types of teenagers, no matter their skill level, weight, or gender. To feel included is ex-

tremely important at this age. Therefore, the site must also be a space where teenagers can hang out and enjoy themselves. The Loop furniture range provides the age-appropriate informal hang-out zone that is so important. The key to activating teenagers is providing a suitable, attractive space.





See more solutions  
on [kompan.com](http://kompan.com)

Minor regional deviations can occur due to differences in safety standards

## PRODUCT INFORMATION

Product number	Product name	Product number	Product name
1	FAZ603 Leg Press Pro	7	FAZ30200 Step, 16 in
2	FAZ602 Pull Down Pro	8	FAZ30300 Step, 24 in
3	FAZ52101 Cross Trainer Pro Touchscreen	9	Configured Multi-Use Sport Area
4	FSW104 Combi 4	10	TPP29510 LOOP Arc
5	FAZ607 Lower Back Bench Pro	11	TPP29530 LOOP Line
6	PAR3005 Sign X-Large		



# FITNESS PACKAGES



## WOOD – MORE THAN 70 EXERCISES

The Wood Fitness Package gives you more than 70 different bodyweight exercises, emphasizing easy, as well as challenging, options. The low pull-up bars and the push-up bars at differing heights are examples of easy starting points. There is no limit to what

you can do on this compact and versatile wooden outdoor fitness site if you are already fit. The prominent characteristic of this site is that all items are based on durable robinia structures.



## CIRCUIT – TAKE YOUR INDOOR CIRCUIT OUTDOORS

The Circuit is a compact, efficient outdoor circuit training area with cardio and strength equipment. This package is based on the well-known circuit setup and includes some of the most popular indoor cardio and

strength machines; the timer makes it perfect for interval training. Ideal for communities and parks, this package has all the best exercises for a high-paced, efficient outdoor workout.





## HOTEL – DON'T SEND HOTEL GUESTS TO THE BASEMENT

This package introduces a high-end outdoor fitness site, an excellent substitute for the traditional hotel fitness center. The site includes a cross-trainer and bike with a touchscreen and adjustable resistance, strength training for the whole body, steps, and functional

training. All equipment is presented in a beautiful and compact setting fit for the most attractive hotels.

See more solutions  
on [kompan.com](http://kompan.com)

Minor regional deviations can occur  
due to differences in safety standards



## PERFORMANCE – EVERYTHING IN ONE SITE

Performance is a versatile training space with equipment fit for many different age groups. Here, you can start your training on the cardio equipment or use the circled area in the middle of the site as circuit training,

as it has strength training equipment ideal for interval training. The training space is surrounded by an obstacle course where you can run, jump, crawl, climb through, and get a sweat-inducing workout.



# CARDIO

## An Adjustable Workout

The striking Cardio range has been awarded the Good Design Award for its innovative and high-quality design. Our Cardio bikes have adjustable resistance and are geometrically tailored to the user's specific workout needs.

The Arm Bike is wheelchair accessible and the Cross Trainer has an innovative sprint mode for shaping thighs and buttocks. All machines are designed to be on par with the best indoor machines!



City Bike Pro Touchscreen  
FAZ50101



Sport Bike Pro Touchscreen  
FAZ50201



 **For a greener future**  
Post-consumer recycled materials:  
Steel parts adhere to industrial standards



### PRODUCT INFORMATION

Product number	Product name		Age (years)	Capacity (users)	Fall height (ft & in)	Total height (ft & in)	Use zone dimensions (ft <sup>2</sup> )	Use zone dimensions (ft & in x ft & in)	Installation (hours)	Total CO <sub>2</sub> e (kg CO <sub>2</sub> e)
FAZ50101	City Bike Pro Touchscreen	✓	13+	1	3'3"	4'6"	60	9'2" x 7'8"	2.4	327
FAZ50100	City Bike Pro	✓	13+	1	3'3"	4'6"	60	9'2" x 7'8"	2.4	327
FAZ50201	Sport Bike Pro Touchscreen		13+	1	3'3"	3'10"	65	9'8" x 7'9"	2.4	326
FAZ50200	Sport Bike Pro		13+	1	3'3"	3'10"	65	9'8" x 7'9"	2.4	326





Arm Bike Pro  
FAZ51100



Cross Trainer Pro Touchscreen  
FAZ52101



## PRODUCT INFORMATION

Product number	Product name		Age (years)	Capacity (users)	Fall height (ft & in)	Total height (ft & in)	Use zone dimensions (ft <sup>2</sup> )	Use zone dimensions (ft & in x ft & in)	Installation (hours)	Total CO <sub>2</sub> e (kg CO <sub>2</sub> e)
FAZ51100	Arm Bike Pro	✓	13+	1	2'0"	3'11"	60	9'1" x 7'10"	2.2	267
FAZ52100	Cross Trainer Pro	✓	13+	1	1'12"	5'9"	94	11'11" x 8'9"	3.9	596
FAZ52101	Cross Trainer Pro Touchscreen	✓	13+	1	1'12"	5'9"	94	11'11" x 8'9"	3.9	597



# STRENGTH

## Full-Body Workout with Adjustable Equipment

The Strength range is a high-quality replication of an indoor exercise setup. These machines use the same biomechanics and resistance mechanisms as indoor selectorized strength machines. These are game changers for the outdoor fitness space!

The machines are safe, easy to use, and time efficient because of the controlled movements and the quick and straightforward resistance selection.



Pull Down Pro  
FAZ602





**For a greener future**  
Post-consumer recycled materials:  
Steel parts adhere to industrial standards



Chest Press Pro  
FAZ601



Leg Press Pro  
FAZ603



### PRODUCT INFORMATION

Product number	Product name		Age (years)	Capacity (users)	Fall height (ft & in)	Total height (ft & in)	Use zone dimensions (ft <sup>2</sup> )	Use zone dimensions (ft & in x ft & in)	Installation (hours)	Total CO <sub>2</sub> e (kg CO <sub>2</sub> e)
FAZ602	Pull Down Pro	✓	13+	1	1'7"	7'0"	129	12'5" x 11'6"	9.3	1,035
FAZ601	Chest Press Pro	✓	13+	1	1'5"	7'0"	113	12'4" x 10'0"	8.6	998
FAZ603	Leg Press Pro	✓	13+	1	2'1"	7'0"	155	11'5" x 15'10"	10	1,697





Shoulder Press Pro  
FAZ604



Horizontal Row Pro  
FAZ605



Sit Up Bench Pro  
FAZ606



Lower Back Bench Pro  
FAZ607



## PRODUCT INFORMATION

Product number	Product name		Age (years)	Capacity (users)	Fall height (ft & in)	Total height (ft & in)	Use zone dimensions (ft <sup>2</sup> )	Use zone dimensions (ft & in x ft & in)	Installation (hours)	Total CO <sub>2</sub> e (kg CO <sub>2</sub> e)
FAZ604	Shoulder Press Pro	✓	13+	1	1'5"	7'0"	130	12'2" x 11'11"	9.3	1,149
FAZ605	Horizontal Row Pro	✓	13+	1	1'7"	7'0"	125	12'2" x 11'3"	9.3	945
FAZ606	Sit Up Bench Pro	✓	13+	1	3'1"	3'1"	102	9'1" x 12'8"	3.4	197
FAZ607	Lower Back Bench Pro	✓	13+	1	2'11"	2'11"	102	10'0" x 11'6"	3.4	151



# CROSS TRAINING



## Scalable Functional Training in a Striking Design

Our Cross Training range draws attention from afar with its dynamic and modern look. The open-frame structures provide scalable resistance on innovative fitness equipment such as suspension trainers, pull-up bars, free weights, and parallel bars.

The Cross Training range is not only appreciated by fitness enthusiasts: In 2017, the range won the Good Design Award and the European Product Design Award.



**For a greener future**  
Post-consumer recycled materials:  
Steel parts adhere to industrial standards



Suspension Trainer Pro  
FAZ10101



Magnetic Bells Pro  
FAZ102



Pull Up Bars Pro  
FAZ103



Parallel Bars Pro  
FAZ104



Core Twist Pro  
FAZ105



## PRODUCT INFORMATION

Product number	Product name		Age (years)	Capacity (users)	Fall height (ft & in)	Total height (ft & in)	Use zone dimensions (ft <sup>2</sup> )	Use zone dimensions (ft & in x ft & in)	Installation (hours)	Total CO <sub>2</sub> e (kg CO <sub>2</sub> e)
FAZ10101	Suspension Trainer Pro	✓	13+	3	0'0"	10'11"	220	14'7" x 17'5"	6.4	850
FAZ102	Magnetic Bells Pro	✓	13+	3	0'0"	10'11"	128	14'7" x 9'5"	7.1	1,034
FAZ103	Pull Up Bars Pro		13+	3	9'5"	10'11"	183	14'7" x 15'2"	7.2	930
FAZ104	Parallel Bars Pro	✓	13+	3	4'1"	10'11"	154	14'7" x 12'8"	6.9	937
FAZ105	Core Twist Pro	✓	13+	3	0'0"	10'11"	127	14'7" x 9'5"	8.6	1,108





Cross Training Pro Combi 1  
FAZ20101



Cross Training Pro Combi 2  
FAZ20301



Cross Training Pro Combi 3  
FAZ20401



Sign X-Large  
PAR3005



## PRODUCT INFORMATION

Product number	Product name		Age (years)	Capacity (users)	Fall height (ft & in)	Total height (ft & in)	Use zone dimensions (ft <sup>2</sup> )	Use zone dimensions (ft & in x ft & in)	Installation (hours)	Total CO <sub>2</sub> e (kg CO <sub>2</sub> e)
FAZ20101	Cross Training Pro Combi 1	✓	13+	10	9'5"	10'11"	508	34'9" x 17'5"	14	2,157
FAZ20301	Cross Training Pro Combi 2	✓	13+	9	4'1"	10'11"	442	34'9" x 17'5"	14	2,183
FAZ20401	Cross Training Pro Combi 3	✓	13+	9	0'0"	10'11"	417	34'9" x 17'5"	15	2,354
PAR3005	Sign X-Large			-	0'0"	6'9"	-	0'0" x 0'0"	1.1	137



# CROSS TRAINING - COMPACT

## Compact Functional Training

The Compact range has customizable features enabling an outdoor functional training solution that fits your needs and wants. Each section offers activities like kettlebells, suspension trainers, or pull-up bars, and is wheelchair accessible.

Available as standalone pieces or as joined structures in a circular or linear combination, this range is perfect for schools, municipalities, or housing areas.



**For a greener future**  
Post-consumer recycled materials:  
Steel parts adhere to industrial standards



Suspension Trainer Compact  
FAZ10701

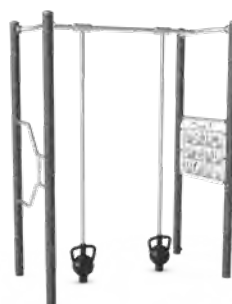

Magnetic Bells Compact  
FAZ108



Core Twist Compact  
FAZ109



Cross Training Combi 4 Compact  
FAZ20501



## PRODUCT INFORMATION

Product number	Product name		Age (years)	Capacity (users)	Fall height (ft & in)	Total height (ft & in)	Use zone dimensions (ft²)	Use zone dimensions (ft & in x ft & in)	Installation (hours)	Total CO <sub>2</sub> e (kg CO <sub>2</sub> e)
FAZ10701	Suspension Trainer Compact	✓	13+	2	0'0"	9'7"	117	6'9" x 17'5"	4.5	538
FAZ108	Magnetic Bells Compact	✓	13+	2	0'0"	9'7"	65	6'9" x 9'9"	5	650
FAZ109	Core Twist Compact	✓	13+	3	7'7"	9'7"	180	13'3" x 18'4"	6.3	683
FAZ20501	Cross Training Combi 4 Compact	✓	13+	4	0'0"	9'7"	182	13'11" x 17'5"	6.7	987





Cross Training Combi 5 Compact  
FAZ20601



Cross Training Combi 6 Compact  
FAZ207



Cross Training Combi 7 Compact  
FAZ20801



Cross Training Combi 8 Compact  
FAZ20901



## PRODUCT INFORMATION

Product number	Product name		Age (years)	Capacity (users)	Fall height (ft & in)	Total height (ft & in)	Use zone dimensions (ft <sup>2</sup> )	Use zone dimensions (ft & in x ft & in)	Installation (hours)	Total CO <sub>2</sub> e (kg CO <sub>2</sub> e)
FAZ20601	Cross Training Combi 5 Compact	✓	13+	5	7'7"	9'7"	296	20'4" x 18'4"	8	1,002
FAZ207	Cross Training Combi 6 Compact	✓		5	7'7"	9'7"	244	20'4" x 18'4"	8.4	1,119
FAZ20801	Cross Training Combi 7 Compact	✓	13+	7	7'7"	9'7"	361	27'5" x 18'4"	11	1,527
FAZ20901	Cross Training Combi 8 Compact	✓	13+	7	7'7"	9'7"	334	25'6" x 19'8"	12	1,674



# STREET WORKOUT

## Combi Products

The Street Workout products are inspired by experts and designed to motivate professionals and fitness enthusiasts. The series comprises various combination packages, offering a complete street workout and calisthenics experience with a minimal footprint.

The affordable Street Workout range offers many exercises in a small space for a large number of fitness enthusiasts.



### For a greener future

Post-consumer recycled materials:

Hercules Rope Yarn

>95%

Steel parts adhere to industrial standards



Combi 1  
FSW101



Combi 2  
FSW102



Combi 3  
FSW103



Combi 4  
FSW104



Combi 5  
FSW105



## PRODUCT INFORMATION

Product number	Product name		Age (years)	Capacity (users)	Fall height (ft & in)	Total height (ft & in)	Use zone dimensions (ft <sup>2</sup> )	Use zone dimensions (ft & in x ft & in)	Installation (hours)	Total CO <sub>2</sub> e (kg CO <sub>2</sub> e)
FSW101	Combi 1		13+	3	7'8"	7'10"	191	16'11" x 15'9"	4.6	371
FSW102	Combi 2		13+	6	7'8"	7'10"	321	25'3" x 19'9"	6	513
FSW103	Combi 3		13+	8	7'8"	7'10"	443	32'1" x 25'8"	8.6	849
FSW104	Combi 4		13+	8	7'8"	7'10"	364	19'8" x 23'11"	8.2	784
FSW105	Combi 5		13+	14	7'8"	7'10"	517	31'2" x 21'3"	11	1,293





Leg Lift & Pull Up  
FSW238



Hexagon Pull-Up Station Pro  
FSW217



Bootcamp Base  
FST930



Multi Timer  
FSW301



Combi 4 with Multi Timer  
FSW302



## PRODUCT INFORMATION

Product number	Product name		Age (years)	Capacity (users)	Fall height (ft & in)	Total height (ft & in)	Use zone dimensions (ft <sup>2</sup> )	Use zone dimensions (ft & in x ft & in)	Installation (hours)	Total CO <sub>2</sub> e (kg CO <sub>2</sub> e)
FSW238	Leg Lift & Pull Up		13+	2	4'4"	7'10"	152	12'7" x 14'9"	3.8	179
FSW217	Hexagon Pull-Up Station Pro	✓	13+	6	7'8"	7'10"	249	17'6" x 17'12"	4.5	508
FST930	Bootcamp Base		13+	8	8'7"	8'7"	372	14'10" x 27'10"	9.6	1,340
FSW301	Multi Timer	✓	13+	4	0'0"	5'7"	-	0'0" x 0'0"	2.1	87
FSW302	Combi 4 with Multi Timer		13+	4	7'8"	7'10"	364	19'8" x 23'11"	9	825



# STREET WORKOUT



Human Flag Wall  
FSW220



Incline Press  
FSW206



Multi Net  
FSW207



Push Up Bars  
FSW209



Pull Up Station  
FSW208



Overhead Ladder, Wide  
FSW205



## PRODUCT INFORMATION

Product number	Product name		Age (years)	Capacity (users)	Fall height (ft & in)	Total height (ft & in)	Use zone dimensions (ft <sup>2</sup> )	Use zone dimensions (ft & in x ft & in)	Installation (hours)	Total CO <sub>2</sub> e (kg CO <sub>2</sub> e)
FSW220	Human Flag Wall		13+	3	7'8"	7'10"	142	12'10" x 12'7"	4.1	331
FSW206	Incline Press	✓	13+	1	7'8"	7'10"	98	9'3" x 12'7"	2.7	157
FSW207	Multi Net	✓	13+	1	7'8"	7'10"	98	9'3" x 12'7"	3.2	158
FSW209	Push Up Bars	✓	13+	3	4'4"	4'7"	239	16'3" x 15'10"	2.7	161
FSW208	Pull Up Station	✓	13+	2	7'8"	7'10"	138	14'3" x 12'7"	3.2	242
FSW205	Overhead Ladder, Wide		13+	2	7'8"	7'10"	124	13'5" x 9'11"	3.5	328





Parallel Bars  
FSW201



Triple Bars  
FSW210

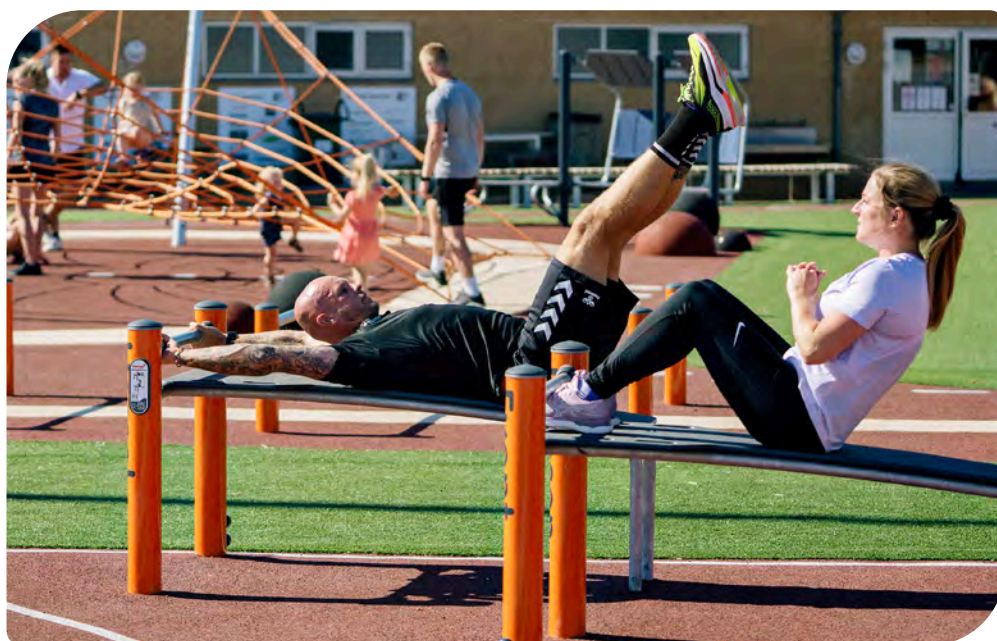

Dip Bench  
FSW202



Sit Up Bench  
FSW203



Decline Bench  
FSW204



Step, 8 in  
FAZ30100



Step, 16 in  
FAZ30200



Step, 24 in  
FAZ30300



Step, 32 in  
FAZ30400



## PRODUCT INFORMATION

Product number	Product name		Age (years)	Capacity (users)	Fall height (ft & in)	Total height (ft & in)	Use zone dimensions (ft <sup>2</sup> )	Use zone dimensions (ft & in x ft & in)	Installation (hours)	Total CO <sub>2</sub> e (kg CO <sub>2</sub> e)
FSW201	Parallel Bars		13+	2	3'6"	3'6"	88	12'5" x 7'9"	2.6	190
FSW202	Dip Bench		13+	2	2'5"	2'5"	112	12'5" x 9'11"	2.6	167
FSW203	Sit Up Bench		13+	1	2'1"	2'8"	110	12'11" x 9'6"	2.9	134
FSW204	Decline Bench		13+	1	2'1"	2'8"	110	12'11" x 9'6"	2.9	131
FSW210	Triple Bars		13+	2	4'7"	4'7"	110	12'5" x 9'7"	3.2	320
FAZ30100	Step, 8 in	✓	13+	1	0'8"	0'8"	86	10'0" x 9'12"	1.7	71
FAZ30101	Step, 8 in PU Steel	✓	13+	1	0'7"	0'7"	86	10'0" x 9'12"	1.6	104
FAZ30200	Step, 16 in	✓	13+	1	1'3"	1'3"	86	10'0" x 9'12"	1.7	75
FAZ30201	Step, 16 in PU Steel	✓	13+	1	1'3"	1'3"	86	10'0" x 9'12"	1.6	108
FAZ30300	Step, 24 in		13+	1	1'11"	1'11"	86	10'0" x 9'12"	1.7	79
FAZ30301	Step, 24 in PU Steel		13+	1	1'10"	1'10"	86	10'0" x 9'12"	1.7	112
FAZ30400	Step, 32 in		13+	1	2'7"	2'7"	86	10'0" x 9'12"	1.7	84
FAZ30401	Step, 32 in PU Steel		13+	1	2'6"	2'6"	86	10'0" x 9'12"	1.7	117



# ROBINIA STREET WORKOUT

## Street Workout in a Natural Style

Our Street Workout range is also available in Robinia wood. This brings the urban street workout trend into a natural environment or the natural environment into an urban setting.

Robinia wood is a solid material with very high levels of natural oils. It's also the most suitable material for an outdoor fitness solution by providing long lasting quality with low maintenance needs.



### For a greener future

#### Robinia wood:

Nature's own material, harvested from European forestry. Robinia wood is known for its natural preservatives that make it long lasting in the outdoors.



Combi 5 Robinia  
FRO105



Combi 2 Robinia  
FRO102

## PRODUCT INFORMATION

All Robinia products are available as FSC®-certified

Product number	Product name		Age (years)	Capacity (users)	Fall height (ft & in)	Total height (ft & in)	Use zone dimensions (ft²)	Use zone dimensions (ft & in x ft & in)	Installation (hours)	Total CO <sub>2</sub> e (kg CO <sub>2</sub> e)
FRO105	Combi 5 Robinia		13+	10	7'8"	8'7"	517	31'3" x 21'3"	21	524
FRO102	Combi 2 Robinia		13+	5	7'8"	8'7"	319	20'6" x 23'11"	11	213





Combi 4 Robinia  
FRO104



Parallel Bars Robinia  
FRO201



Sit Up Bench Robinia  
FRO203



Dip Bench Robinia  
FRO202



Push Up Bars Robinia  
FRO209



Multi Timer Robinia  
FRO222

## PRODUCT INFORMATION

All Robinia products are available as FSC®-certified

Product number	Product name		Age (years)	Capacity (users)	Fall height (ft & in)	Total height (ft & in)	Use zone dimensions (ft <sup>2</sup> )	Use zone dimensions (ft & in x ft & in)	Installation (hours)	Total CO <sub>2</sub> e (kg CO <sub>2</sub> e)
FRO104	Combi 4 Robinia		13+	8	7'8"	8'7"	363	19'8" x 23'11"	15	316
FRO201	Parallel Bars Robinia		13+	1	3'6"	4'5"	88	12'5" x 7'9"	3.4	48
FRO203	Sit Up Bench Robinia		13+	1	2'1"	3'5"	110	9'6" x 12'11"	3.3	78
FRO202	Dip Bench Robinia		13+	2	2'5"	2'5"	125	13'9" x 9'11"	3.6	81
FRO209	Push Up Bars Robinia	✓	13+	3	4'4"	5'3"	240	16'5" x 15'10"	4.2	38
FRO222	Multi Timer Robinia	✓	13+	4	0'0"	5'10"	-	0'0" x 0'0"	1.5	53



# STAY FIT

## Balance, Strength, and Mobility

The Stay Fit range comprises equipment that improves balance, strength, and mobility. Suitable for users of an older age, Stay Fit enables users to train in fall prevention, balance training, and is beneficial for those recovering from moderate to severe injuries.



**For a greener future**  
 Post-consumer recycled materials:  
 Steel parts adhere to industrial standards



Balance Board  
**FSW231**

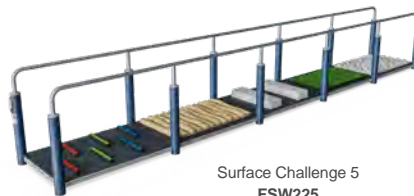

Surface Challenge 5  
**FSW225**

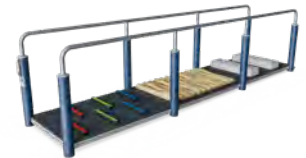

Surface Challenge 3  
**FSW224**



Stretch Station  
**FSW223**



Flex Wheel  
**FSW226**

### PRODUCT INFORMATION

Product number	Product name		Age (years)	Capacity (users)	Fall height (ft & in)	Total height (ft & in)	Use zone dimensions (ft <sup>2</sup> )	Use zone dimensions (ft & in x ft & in)	Installation (hours)	Total CO <sub>2</sub> e (kg CO <sub>2</sub> e)
FSW231	Balance Board	✓	13+	1	0'5"	6'7"	84	8'9" x 10'9"	4.8	280
FSW225	Surface Challenge 5	✓	13+	9	0'8"	3'5"	252	8'11" x 28'12"	12	1,134
FSW224	Surface Challenge 3	✓	13+	5	0'8"	3'5"	169	8'11" x 19'9"	7.8	688
FSW223	Stretch Station	✓	13+	4	6'4"	6'7"	153	12'10" x 16'4"	4.1	296
FSW226	Flex Wheel	✓	13+	1	0'0"	5'5"	95	15'2" x 7'4"	3.1	75





## PRODUCT INFORMATION

Product number	Product name		Age (years)	Capacity (users)	Fall height (ft & in)	Total height (ft & in)	Use zone dimensions (ft <sup>2</sup> )	Use zone dimensions (ft & in x ft & in)	Installation (hours)	Total CO <sub>2</sub> e (kg CO <sub>2</sub> e)
FSW222	Assisted Step	✓	13+	1	0'8"	3'10"	86	10'0" x 9'12"	2.7	166
FSW227	Balance Station	✓	13+	4	0'10"	4'1"	180	15'11" x 15'9"	4.7	416
FSW228	Up & Go	✓	13+	1	0'0"	3'1"	198	19'3" x 13'6"	2.8	175
FSW229	Stairs & Ramp	✓	13+	2	2'3"	5'4"	165	8'11" x 19'3"	11	932
FSW230	Double Stairs	✓	13+	2	2'3"	5'4"	117	8'11" x 13'11"	9.9	611



# STAY FIT



Twist & Flex Wheel  
FSW236



Flex Wheel & Leg Lift  
FSW237



## PRODUCT INFORMATION

Product number	Product name		Age (years)	Capacity (users)	Fall height (ft & in)	Total height (ft & in)	Use zone dimensions (ft <sup>2</sup> )	Use zone dimensions (ft & in x ft & in)	Installation (hours)	Total CO <sub>2</sub> e (kg CO <sub>2</sub> e)
FSW236	Twist & Flex Wheel	✓	13+	2	0'8"	5'5"	161	15'2" x 14'10"	4.1	170
FSW237	Flex Wheel & Leg Lift	✓	13+	2	4'4"	5'6"	165	15'2" x 14'3"	4.3	155







# OBSTACLE COURSES

## Challenging All

Obstacle courses are just a great way to exercise. Smart step-ups and extra grips make it easy for beginners to conquer the course, and due to the equipment size and height, even the most advanced athletes will find a way to challenge themselves!

Our obstacle courses are designed to challenge everyone at their own level. Enjoy the moment when you achieve your new personal best!



### For a greener future

Post-consumer recycled materials:

Hercules Rope Yarn

>95%

Steel parts adhere to industrial standards



Vertical Net and Wall  
FSW216



Double Turbo Challenge  
FSW21201



Double Overhead Ladder  
FSW213



Balance Beam  
FSW215



## PRODUCT INFORMATION

Product number	Product name		Age (years)	Capacity (users)	Fall height (ft & in)	Total height (ft & in)	Use zone dimensions (ft <sup>2</sup> )	Use zone dimensions (ft & in x ft & in)	Installation (hours)	Total CO <sub>2</sub> e (kg CO <sub>2</sub> e)
FSW216	Vertical Net and Wall		13+	3	7'8"	7'10"	168	12'10" x 15'9"	6.9	511
FSW21201	Double Turbo Challenge		13+	3	7'5"	8'10"	245	22'8" x 11'12"	5.2	621
FSW213	Double Overhead Ladder		13+	4	7'8"	7'10"	195	20'6" x 9'11"	4.9	536
FSW215	Balance Beam		13+	3	1'4"	1'6"	278	26'9" x 19'8"	3.7	216





Jump Pod Set  
FSW221



Hurdles  
FSW211



Over Under  
FSW214



Combi Steps  
FSW219



Square Pull-Up Station  
FSW218



## PRODUCT INFORMATION

Product number	Product name		Age (years)	Capacity (users)	Fall height (ft & in)	Total height (ft & in)	Use zone dimensions (ft <sup>2</sup> )	Use zone dimensions (ft & in x ft & in)	Installation (hours)	Total CO <sub>2</sub> e (kg CO <sub>2</sub> e)
FSW221	Jump Pod Set		13+	1	1'12"	1'12"	102	10'4" x 12'7"	1.7	126
FSW211	Hurdles		13+	5	1'4"	1'10"	340	10'8" x 33'7"	4.4	379
FSW214	Over Under		13+	4	3'10"	3'10"	302	10'6" x 30'9"	3.7	353
FSW219	Combi Steps		13+	4	2'7"	2'7"	277	10'0" x 29'8"	4	308
FSW218	Square Pull-Up Station	✓	13+	4	7'8"	7'10"	159	14'4" x 14'4"	3.7	341



# ROBINIA OBSTACLE COURSES

## Obstacle Courses in a Natural Style

The Robinia Obstacle Courses are designed to challenge everyone. Smart step-ups and extra grips will make it easy for beginners to get started on the equipment, and due to the size and height of the equipment, even the most advanced athletes will find a way to challenge themselves!

Robinia wood is a durable material, making this a long lasting, low-maintenance outdoor fitness solution.



### For a greener future

#### Robinia wood:

Nature's own material, harvested from European forestry. Robinia wood is known for its natural preservatives that make it long lasting in the outdoors.



Vertical Net/Wall Robinia  
FRO216



Double Overhead Ladder Robinia  
FRO213



Square Pull-Up Station Robinia  
FRO218

## PRODUCT INFORMATION

All Robinia products are available as FSC®-certified

Product number	Product name		Age (years)	Capacity (users)	Fall height (ft & in)	Total height (ft & in)	Use zone dimensions (ft²)	Use zone dimensions (ft & in x ft & in)	Installation (hours)	Total CO <sub>2</sub> e (kg CO <sub>2</sub> e)
FRO216	Vertical Net/Wall Robinia		13+	3	7'8"	8'7"	168	12'10" x 15'9"	9.5	341
FRO213	Double Overhead Ladder Robinia		13+	4	7'8"	8'7"	195	20'6" x 9'11"	7.8	196
FRO218	Square Pull-Up Station Robinia	✓	13+	4	7'8"	8'7"	159	14'4" x 14'4"	5.9	128



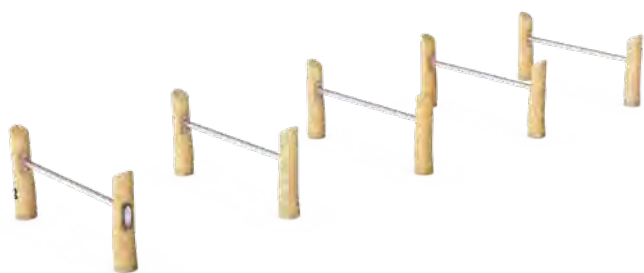

Hurdles Robinia  
FRO211



Over Under Robinia  
FRO214



Balance Beam Robinia  
FRO215



Double Turbo Challenge Robinia  
FRO212

## PRODUCT INFORMATION

All Robinia products are available as FSC®-certified

Product number	Product name		Age (years)	Capacity (users)	Fall height (ft & in)	Total height (ft & in)	Use zone dimensions (ft²)	Use zone dimensions (ft & in x ft & in)	Installation (hours)	Total CO <sub>2</sub> e (kg CO <sub>2</sub> e)
FRO211	Hurdles Robinia		13+	5	1'8"	2'7"	340	10'8" x 33'7"	7.3	127
FRO214	Over Under Robinia		13+	4	3'10"	4'10"	302	10'6" x 30'9"	5.7	80
FRO215	Balance Beam Robinia		13+	3	2'0"	2'0"	348	33'11" x 16'11"	5.5	34
FRO212	Double Turbo Challenge Robinia		13+	3	7'5"	9'7"	245	22'8" x 12'0"	8.1	256



## Personal Digital Trainer

The app provides motivation, education, and inspiration at the same level as a personal trainer. It guides you through exercises, suggests workout programs, and tracks activities.



SEE MORE

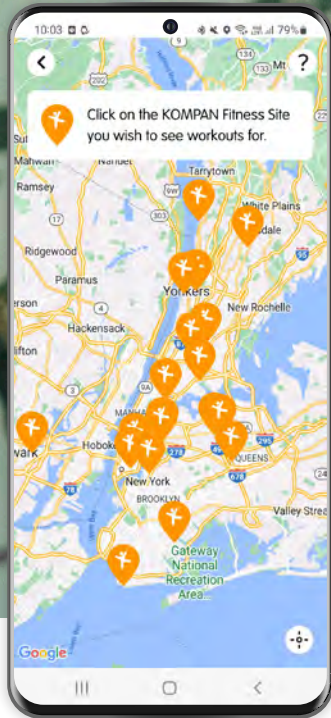

## Find a Fitness Site Near You

The app uses the user's location to point to the nearest KOMPAN fitness site. For each suggested site, the user can see which equipment is at the site and guides on how to use the equipment.

# A CONNECTED EXPERIENCE

## THE KEY TO CREATING POPULAR FITNESS SITES

The KOMPAN Outdoor Fitness app is the ideal digital personal trainer to kickstart your exercise journey. The app also teaches you how to use the equipment and keeps you motivated. It's an online exercise guide for all ages, fitness levels, and experiences.

- See videos of exercises for all types of equipment
- Get workouts for different goals and levels
- Find the nearest fitness site on the map
- Connect to cardio equipment and save your data in Google Fit or Apple Health



**KOMPAN Outdoor Fitness app**  
Available for download in the AppStore or Google Play.

**KOMPAN®**



# FLEXIBILITY

With a variety of colors and part options, we offer lots of flexibility and customization with our standard products.



Lime\*



Orange\*



Light Blue\*

# OPTIONS



PRODUCT CONFIGURATOR  
www.kompan.com

Post cap



– In grey PE or aluminium

\*) Steel colors



Anchoring type

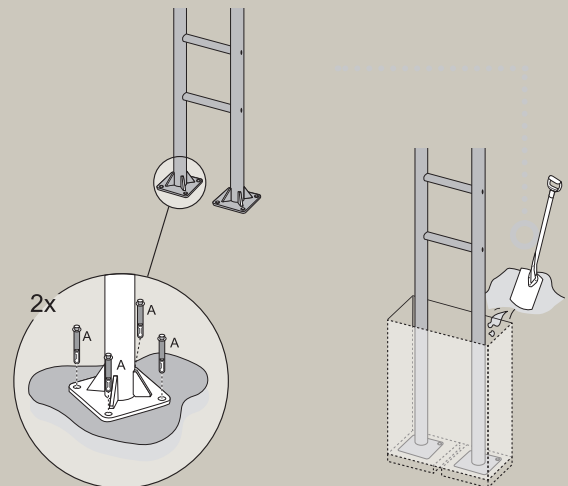

– Surface with expansion bolts

– In-ground with multiple depths

## More flexibility

Contact us for more information on the wide range of options for configurable outdoor fitness. Please note that prices and delivery terms depend on specified configurations.







# MULTI-SPORT





# CITY CENTER



## MUSA SOLUTION

In urban areas, space is often scarce, and contemporary city centers have not been planned to promote an active lifestyle. There is always traffic and people moving around, and, as we all know, balls and cars are not a good match. Luckily, there is a growing willingness to create spaces where children and adults can engage in ball sports and other activities. This Multi-Use Sports Area (MUSA) is the perfect solution for a densely

populated area because it is tall and fully enclosed, ensuring that all balls stay within the court. Secondly, it has an open and transparent design, making it easy to see what is happening on and off the court without obstructing views.

MUSA is a compact integrated system that offers a tremendous amount of functionality in a safe and enclosed environment.





See more solutions  
on [kompan.com](https://www.kompan.com)

Minor regional deviations can occur due to differences in safety standards

## PRODUCT INFORMATION

Product  
number

Product name

**1** FRE600201 MUSA, 39 x 79 ft, Steel, 16 ft Walls, Rectangle



# CENTRAL PARK



## MUSA SOLUTION

Public parks have gained immense popularity in recent times, drawing a diverse range of individuals. Some of them come to relax, read a book, or simply enjoy the green areas. Others come to meet people and be active. Sometimes, these different uses can create friction, like children running through a picnic chasing after a ball.

This can easily be prevented by creating active and non-active zones in a park, and a Multi-Use Sports Area (MUSA) is a great

way to delineate these zones. It's designed to keep the ball inside the court and facilitate many different sports.

By choosing the Wood Plastic Composite panels, the MUSA blends into the park environment while at the same time being maintenance-free. The lifetime warranty on the steel structural parts is important because this is a site that will be heavily used and enjoyed by many!





See more solutions  
on [kompan.com](https://www.kompan.com)

Minor regional deviations can occur due to differences in safety standards

## PRODUCT INFORMATION

Product number	Product name
1	Configured Multi-Use Sport Area
2	Robinia Obstacle Course
3	PAR1011 Rumba Table, Round, 4 ft 3in
4	PAR1006 Rumba Bench, Curved 90°



# SCHOOLYARD GAMES



1

## MUSA SOLUTION

A KOMPAN Multi-Use Sports Area (MUSA) is designed as a flexible system to fit any purpose or environment. The intelligent design allows the MUSAs to host many kinds of games, such as football, basketball, hockey, volleyball, tennis, handball, badminton, and so much more.

Ball sports areas in schools are popular and both teachers and children are enthusiastic about them. The teachers unanimously say that the fields have meant more physical activity with fewer conflicts during breaks.

The fields have also brought about more concentration and willingness to learn for the children in the classroom. And the children? They are extremely happy to have the right to an open invitation to fun and play!

The fully flat inside of the MUSAs will keep the ball in play, thus intensifying the game as there are fewer involuntary breaks. At the same time, children not playing in the MUSA won't be disturbed by balls flying outside the MUSA.





See more solutions  
on [kompan.com](http://kompan.com)

Minor regional deviations can occur due to differences in safety standards

## PRODUCT INFORMATION

Product number	Product name
1 FRE600501	MUSA, 36 x 49 ft, Steel, 3 ft Walls
2 BLX4103	BLOQX 3
3 FRE601201	Panna, Low
4 GXY960	Supernova



# MULTI-USE SPORTS AREAS

## Multi-Activities – The Ball is in Your Court

The MUSA is to sport what a convenience store is to shopping. It provides an optimized arena, a focal point for activity, and a place specifically designed to satisfy a need. These compact stadiums are an essential social asset in creating a healthy and engaging community.

MUSAs are where rules are not set in stone but most certainly agreed upon. The only common rule is to have lots of fun.

OTHER SIZES AVAILABLE



MUSA, 36 x 49 ft, Steel, 3 ft Walls  
**FRE600501**



**For a greener future**  
Post-consumer recycled materials:  
EcoCore™ Panels >95%

Steel parts adhere to industrial standards



MUSA, 39 x 79 ft, Steel, 3 ft Walls  
**FRE600101**



MUSA, 39 x 79 ft, WPC, 3 ft Walls  
**FRE600103**



MUSA, 39 x 79 ft, Steel/HDPE, 3 ft Walls  
**FRE600102**



MUSA, 39 x 79 ft, Steel, 16 ft Walls, Rectangle  
**FRE600201**



MUSA, 43 x 85 ft, WPC, 3 ft Walls  
**FRE600803**

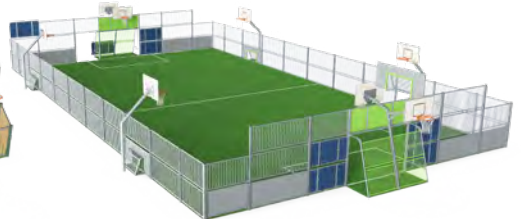

MUSA, 52 x 102 ft, Steel/HDPE, 7 ft Walls  
**FRE601001**

## PRODUCT INFORMATION

Product number	Product name		Age (years)	Capacity (users)	Fall height (ft & in)	Total height (ft & in)	Use zone dimensions (ft <sup>2</sup> )	Use zone dimensions (ft & in x ft & in)	Installation (hours)	Total CO <sub>2</sub> e (kg CO <sub>2</sub> e)
<b>FRE600501</b>	MUSA, 36 x 49 ft, Steel, 3 ft Walls		3+	-	0'0"	12'1"	-	0'0" x 0'0"	34	4,500
<b>FRE600101</b>	MUSA, 39 x 79 ft, Steel, 3 ft Walls		3+	-	0'0"	12'1"	-	0'0" x 0'0"	34	5,710
<b>FRE600103</b>	MUSA, 39 x 79 ft, WPC, 3 ft Walls		3+	-	0'0"	12'1"	-	0'0" x 0'0"	59	5,858
<b>FRE600102</b>	MUSA, 39 x 79 ft, Steel/HDPE, 3 ft Walls		3+	-	0'0"	12'1"	-	0'0" x 0'0"	76	5,123
<b>FRE600201</b>	MUSA, 39 x 79 ft, Steel, 16 ft Walls, Rectangle		3+	-	0'0"	16'6"	-	0'0" x 0'0"	76	9,231
<b>FRE600803</b>	MUSA, 43 x 85 ft, WPC, 3 ft Walls		3+	-	0'0"	12'1"	-	0'0" x 0'0"	55	5,411
<b>FRE601001</b>	MUSA, 52 x 102 ft, Steel/HDPE, 7 ft Walls		3+	-	0'0"	12'1"	-	0'0" x 0'0"	103	11,375





Multi Goal, 10 ft, Steel  
FRE601401



Multi Goal, 26 ft, Steel  
FRE601501



Multi Goal, 39 ft, Steel  
FRE601601



Panna, Low  
FRE601201



Panna, High  
FRE601301



## PRODUCT INFORMATION

Product number	Product name		Age (years)	Capacity (users)	Fall height (ft & in)	Total height (ft & in)	Use zone dimensions (ft <sup>2</sup> )	Use zone dimensions (ft & in x ft & in)	Installation (hours)	Total CO <sub>2</sub> e (kg CO <sub>2</sub> e)
FRE601401	Multi Goal, 10 ft, Steel		3+	-	0'0"	12'1"	-	0'0" x 0'0"	7.4	848
FRE601501	Multi Goal, 26 ft, Steel		3+	-	0'0"	12'1"	-	0'0" x 0'0"	9.9	1,329
FRE601601	Multi Goal, 39 ft, Steel		3+	-	0'0"	12'1"	-	0'0" x 0'0"	13	2,036
FRE601201	Panna, Low		3+	-	0'0"	3'5"	-	0'0" x 0'0"	8.3	1,156
FRE601301	Panna, High		3+	-	0'0"	6'8"	-	0'0" x 0'0"	13	2,114



# COSMOS MULTI-SPORT

## A Player-Friendly Experience

### Cosmos Multi-Sport

Cosmos offers a variety of sporting activities. A basketball hoop at the NBA-standard height enticingly hovers over the area, while goals and nets invite a game of football or handball. Kickball games are great for social interaction, light-hearted competition and fostering friendships while promoting active and healthy lifestyles.

Similar to the rest of the Multi-Sport range, the Cosmos invites passing children to stop and ask, "Can I join?"

OTHER SIZES AVAILABLE

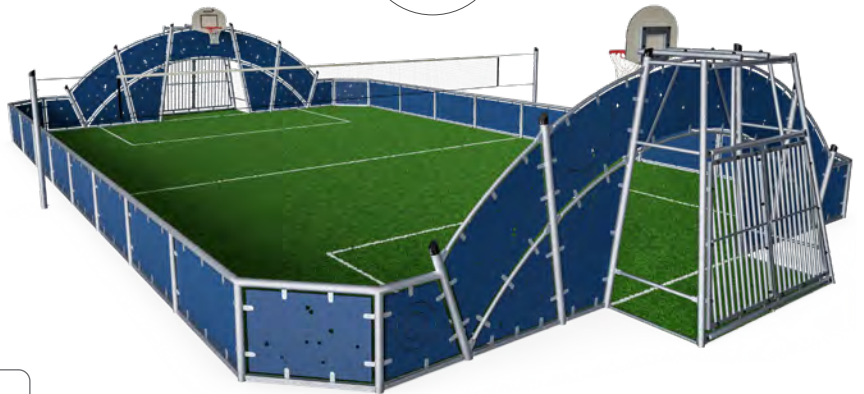

Cosmos, 39 x 68 ft  
**FRE2110**



### For a greener future

Post-consumer recycled materials:

EcoCore™ Panels

>95%

Steel parts adhere to industrial standards



Multi Goal, 10 ft  
**FRE2210**



Multi Goal, 16 ft  
**FRE2211**



Multi Goal, 30 ft  
**FRE2212**



Multi Goal, 39 ft  
**FRE2213**

## PRODUCT INFORMATION

Product number	Product name		Age (years)	Capacity (users)	Fall height (ft & in)	Total height (ft & in)	Use zone dimensions (ft²)	Use zone dimensions (ft & in x ft & in)	Installation (hours)	Total CO <sub>2</sub> e (kg CO <sub>2</sub> e)
<b>FRE2110</b>	Cosmos, 39 x 68 ft		3+	-	0'0"	12'2"	-	0'0" x 0'0"	70	5,751
<b>FRE2111</b>	Cosmos, 39 x 81 ft		3+	-	0'0"	12'2"	-	0'0" x 0'0"	76	6,213
<b>FRE2113</b>	Cosmos, 48 x 101 ft		3+	-	0'0"	12'2"	-	0'0" x 0'0"	90	7,260
<b>FRE2115</b>	Cosmos, 52 x 107 ft		3+	-	0'0"	12'2"	-	0'0" x 0'0"	94	7,605
<b>FRE2116</b>	Cosmos, 61 x 120 ft		3+	-	0'0"	12'2"	-	0'0" x 0'0"	104	8,413
<b>FRE2210</b>	Multi Goal, 10 ft		3+	-	0'0"	12'2"	-	0'0" x 0'0"	8.9	980
<b>FRE2211</b>	Multi Goal, 16 ft		3+	-	0'0"	12'2"	-	0'0" x 0'0"	13	1,277
<b>FRE2212</b>	Multi Goal, 30 ft		3+	-	0'0"	12'2"	-	0'0" x 0'0"	17	1,569
<b>FRE2213</b>	Multi Goal, 39 ft		3+	-	0'0"	12'2"	-	0'0" x 0'0"	21	1,903





Goal  
FRE3050



Mini Goal  
FRE3051

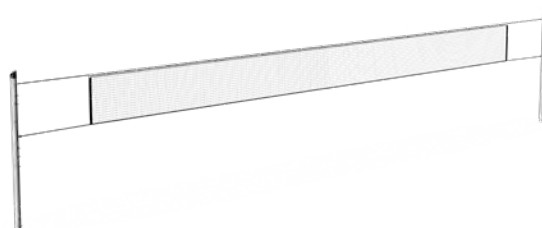

Multi Net  
FRE3031



Basketball Goal, Nylon Net  
FRE3025



Surprise Basket  
FRE3024



Sit & Stand  
FRE3054

## PRODUCT INFORMATION

Product number	Product name		Age (years)	Capacity (users)	Fall height (ft & in)	Total height (ft & in)	Use zone dimensions (ft <sup>2</sup> )	Use zone dimensions (ft & in x ft & in)	Installation (hours)	Total CO <sub>2</sub> e (kg CO <sub>2</sub> e)
FRE3050	Goal		3+	-	0'0"	6'7"	-	0'0" x 0'0"	1.3	531
FRE3051	Mini Goal		3+	-	0'0"	2'6"	-	0'0" x 0'0"	1.6	126
FRE3031	Multi Net		3+	-	0'0"	8'7"	-	0'0" x 0'0"	0.9	149
FRE3025	Basketball Goal, Nylon Net		3+	-	0'0"	12'1"	-	0'0" x 0'0"	2.9	273
FRE3024	Surprise Basket		3+	-	0'0"	10'0"	-	0'0" x 0'0"	1	130
FRE3054	Sit & Stand		3+	-	0'0"	3'7"	-	0'0" x 0'0"	0.8	92



# FLEXIBILITY

With a variety of colors and part options, we offer lots of flexibility and customization with our standard products.

## Post Options:

- Height from 3ft to 16ft
- Hot-dip galvanized
- Hot-dip galvanized and powder-coated Dark green

## Panel Options:

- Steel tubes
- HDPE plates
- Wood Plastic Composite (WPC)
- Ball-catcher net

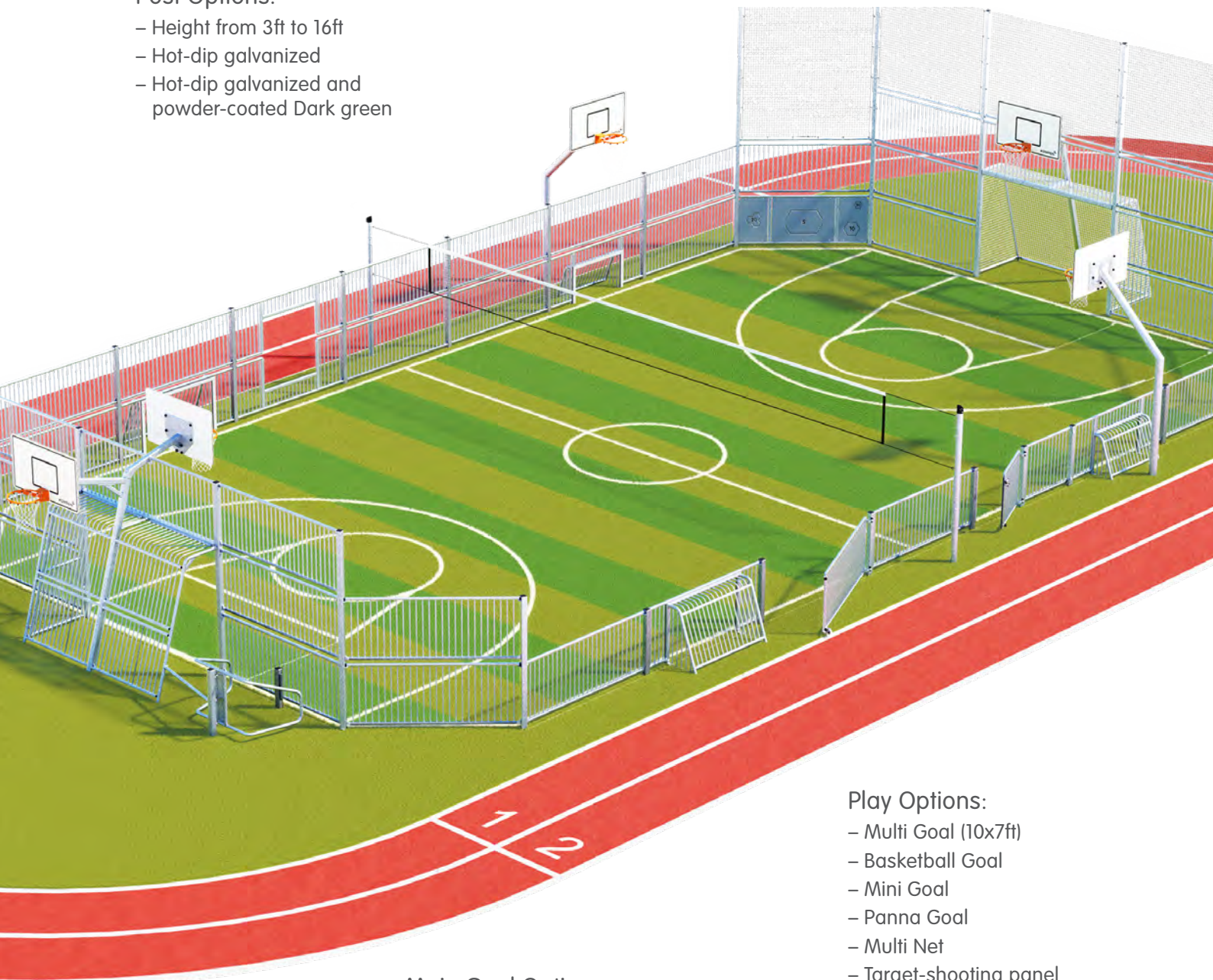

## Main Goal Options:

- Outside basket
- Fully closed steel
- Fully closed net
- Open goal sides for entrance
- Inclusive wheelchair entrance

## Play Options:

- Multi Goal (10x7ft)
- Basketball Goal
- Mini Goal
- Panna Goal
- Multi Net
- Target-shooting panel



# OPTIONS



PRODUCT CONFIGURATOR  
www.kompan.com

## CONFIGURE WITH A FEW SIMPLE STEPS

### 1. Choose size and height

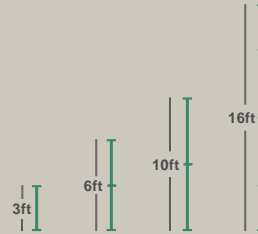

### 2. Choose materials and colors

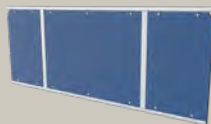

Panel colors



WPC (Wood Plastic Composite)

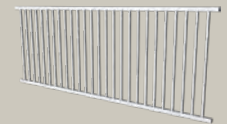

Steel colors, all fine-texture mat steel



Hot-dip galvanized steel



### 3. Choose play types

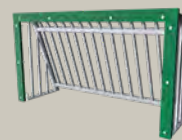

### Access Options:

- Entrance gate
- Service gate
- Hockey entrance

### 4. Choose entrance module

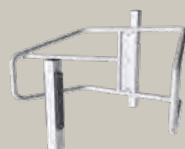

### 5. Choose accessibility



## More flexibility

Contact us for more information on the wide range of options for configurable MUSAs. Please note that prices and delivery terms depend on specified configurations.







# OUTDOOR FURNITURE





# AGORA™

## Beautiful, Inclusive, and Versatile

The Agora product line offers high flexibility regarding anchoring, color, and material options to inspire architectural creativity. Agora products are also available in vandalism-resistant, low-maintenance, and durable perforated steel versions.

Developed according to the latest inclusive design principles for outdoor furniture without compromising design qualities, Agora has won the Red Dot Design Award.



### For a greener future

Post-consumer recycled materials:

Steel parts adhere to industrial standards



reddot winner 2020  
urban design



Agora Furniture Group 1  
PAR4058



Agora Bench  
PAR4050

Agora Bench with Backrest  
PAR4051

Agora Table  
PAR4052

Agora Stool  
PAR4060

Agora Chair  
PAR4061

Agora Square Table  
PAR4062

Agora Hangout Bench  
PAR4063

Agora Hangout Table  
PAR4064

## PRODUCT INFORMATION

Product number	Product name	Height Seat/table ft & in	Product dimensions (ft & in x ft & in)	Installation (hours)	Total CO <sub>2</sub> e (kg CO <sub>2</sub> e)
PAR4058	Agora Furniture Group 1	1'8" / 2'7"	5'11" x 5'10"	2.1	130
PAR4050	Agora Bench	1'8" / -	5'7" x 1'2"	0.4	31
PAR4051	Agora Bench with Backrest	1'8" / -	5'11" x 1'8"	1.1	47
PAR4052	Agora Table	- / 2'7"	4'4" x 1'11"	0.7	51
PAR4060	Agora Stool	1'8" / -	1'2" x 1'2"	0.2	18
PAR4061	Agora Chair	1'8" / -	2'4" x 1'8"	0.9	46
PAR4062	Agora Square Table	- / 2'7"	1'11" x 1'11"	0.4	30
PAR4063	Agora Hangout Bench	2'4" / -	4'11" x 0'9"	0.5	39
PAR4064	Agora Hangout Table	- / 3'3"	0'9" x 4'11"	0.5	45



# FLEXIBILITY

With a variety of colors and part options, we offer lots of flexibility and customization with our standard products.

## Full Steel Colors



Red



Dark Green



Lime



Orange



Yellow



Medium Blue



Light Blue



Black



Anthracite

# OPTIONS

## Steel frames



Ash wood



Pine wood

## Full steel



Bench



Table

## Modular extensions – Steel benches



## Picnic table options



## Modular extensions – Picnic tables



## More flexibility

Contact us for more information on the wide range of options for configurable outdoor furniture. Please note that prices and delivery terms depend on specified configurations.



# AGORA™ PICNIC

## Inclusive Design as Standard

Agora Picnic is a flexible and freestanding furniture set for ten people. The bench and tabletop are made of high-quality ash wood and HPL (high-pressure laminate) or perforated steel. The steel frame is galvanized with the option of powder coating.

Keeping the sides open makes it easy for wheelchair users to approach the table and be comfortably seated. The picnic table is available in two sizes.



**For a greener future**  
Post-consumer recycled materials:  
Steel parts adhere to industrial standards



reddot winner 2020  
urban design



Agora Picnic Mini - Wood  
PAR4080



Agora Picnic Mini, Yellow  
PAR4083



Agora Picnic Table Mini Set  
PAR4180



Agora Picnic Table  
PAR4070



Agora Picnic Table, Blue  
PAR4075



Agora Picnic Table Set  
PAR4170

## PRODUCT INFORMATION

Product number	Product name	Height Seat/table ft & in	Product dimensions (ft & in x ft & in)	Installation (hours)	Total CO <sub>2</sub> e (kg CO <sub>2</sub> e)
PAR4080	Agora Picnic Mini - Wood	1'2" / 1'12"	3'5" x 4'5"	1.6	91
PAR4083	Agora Picnic Mini, Yellow	1'2" / 1'12"	3'5" x 5'7"	1.5	151
PAR4180	Agora Picnic Table Mini Set	1'2" / 1'12"	3'5" x 4'5"	2.8	216
PAR4070	Agora Picnic Table	1'7" / 2'6"	5'6" x 6'7"	2.2	147
PAR4075	Agora Picnic Table, Blue	1'7" / 2'6"	5'6" x 6'7"	2.4	307
PAR4170	Agora Picnic Table Set	1'7" / 2'6"	5'6" x 6'7"	3.4	364



# RUMBA™

## Contemporary Designs for All Environments

A curvy yet square shape gives the Rumba range its contemporary, modern look. A high-quality ash wood aesthetic ensures this range blends beautifully with the surroundings. The ability to create rounded or straight configurations encourages a high level of versatility.

The low-maintenance Rumba range will help bring your community together and promote outdoor activity and moments of relaxation.



**For a greener future**  
Post-consumer recycled materials:  
Steel parts adhere to industrial standards



Rumba Suncouch 5ft 2in  
**PAR1013**



Rumba Suncouch 3ft  
**PAR1012**



Rumba Suncouch Armrest  
**PAR1038**



Rumba Bench, Straight, 6ft  
**PAR1002**



Rumba Back Support 6ft  
**PAR1015**



Rumba Table, Square, 6ft  
**PAR1009**



Rumba Armrest  
**PAR1016**



Rumba Bench, Curved 90°  
**PAR1006**



Rumba Backrest, 90° Outside  
**PAR1037**



Rumba Table, Round, 4 ft 3in  
**PAR1011**



Rumba Bench Table  
**PAR1019**

### PRODUCT INFORMATION

Product number	Product name	Height Seat/table ft & in	Product dimensions (ft & in x ft & in)	Installation (hours)	Total CO <sub>2</sub> e (kg CO <sub>2</sub> e)
PAR1013	Rumba Suncouch 5ft 2in	1'6" / -	5'3" x 4'11"	2.1	190
PAR1012	Rumba Suncouch 3ft	1'6" / -	2'11" x 4'11"	1.6	156
PAR1038	Rumba Suncouch Armrest	- / -	1'5" x 0'3"	0.2	5
PAR1002	Rumba Bench, Straight, 6ft	1'5" / -	6'0" x 1'8"	1	68
PAR1015	Rumba Back Support 6ft	- / -	6'1" x 1'8"	0.9	12
PAR1009	Rumba Table, Square, 6ft	- / 2'4"	6'0" x 2'7"	1.4	101
PAR1016	Rumba Armrest	- / -	1'3" x 0'4"	0.2	5
PAR1006	Rumba Bench, Curved 90°	1'5" / -	4'2" x 4'2"	0.9	63
PAR1037	Rumba Backrest, 90° Outside	- / -	4'6" x 4'6"	1	35
PAR1011	Rumba Table, Round, 4 ft 3in	- / 2'4"	4'3" x 4'3"	1.8	122
PAR1019	Rumba Bench Table	- / 2'4"	1'8" x 2'3"	1.1	20



# ANITA™

## Classic, Low-Maintenance Park Furniture

Park furniture is an indispensable part of public spaces and has been vital in bringing communities together for years. The Anita range invites people to engage with their community and enjoy the natural surroundings.

Its classic wooden aesthetic makes the Anita range look great along walkways and in town squares, shopping centers, and building entrances.



**For a greener future**  
Post-consumer recycled materials:  
Steel parts adhere to industrial standards



Anita Bench  
PAR1050



Anita Bench with Backrest  
PAR1051



Anita Table  
PAR1052



Anita Chair  
PAR1053



Anita Round Table  
PAR1062



Anita Square Bench with Backrest  
PAR1054



Anita Square Bench  
PAR1055



Anita Picnic Mini  
PAR1059



Anita Picnic  
PAR1060



Anita Picnic - HPL  
PAR1405



Anita Picnic - Inclusion  
PAR1403



Anita Picnic Mini - HPL  
PAR1404

### PRODUCT INFORMATION

Product number	Product name	Height Seat/table ft & in	Product dimensions (ft & in x ft & in)	Installation (hours)	Total CO <sub>2</sub> e (kg CO <sub>2</sub> e)
PAR1050	Anita Bench	1'5" / -	5'11" x 1'11"	0.6	36
PAR1051	Anita Bench with Backrest	1'5" / -	5'11" x 1'10"	0.8	49
PAR1052	Anita Table	- / 2'4"	4'3" x 1'11"	0.6	38
PAR1053	Anita Chair	1'5" / -	1'12" x 1'10"	0.5	36
PAR1062	Anita Round Table	- / 2'11"	2'6" x 2'6"	0.6	41
PAR1054	Anita Square Bench with Backrest	1'5" / -	5'11" x 5'11"	3.9	192
PAR1055	Anita Square Bench	1'5" / -	5'11" x 5'11"	2.7	143
PAR1059	Anita Picnic Mini	1'1" / 1'12"	6'7" x 4'0"	1.7	73
PAR1060	Anita Picnic	1'6" / 2'4"	6'7" x 4'10"	1.8	86
PAR1405	Anita Picnic - HPL	1'6" / 2'4"	4'11" x 4'11"	1.4	174
PAR1403	Anita Picnic - Inclusion	1'6" / 2'4"	7'10" x 4'10"	1.8	85
PAR1404	Anita Picnic Mini - HPL	0'12" / 1'11"	4'11" x 4'1"	1.3	161



# CHATTER™



Chatter Table  
PAR1152



Chatter Bench with Backrest  
PAR1151



Chatter Bench  
PAR1155



Chatter Bench with Backrest and Armrest  
PAR1156



Bicycle Stand  
PAR3001



Dustbin 60 L  
KPL205

STAND OR  
WALL MOUNT



## PRODUCT INFORMATION

Product number	Product name	Height Seat/table ft & in	Product dimensions (ft & in x ft & in)	Installation (hours)	Total CO <sub>2</sub> e (kg CO <sub>2</sub> e)
PAR1152	Chatter Table	- / 3'3"	3'7" x 1'9"	0.5	31
PAR1151	Chatter Bench with Backrest	1'5" / -	5'3" x 1'8"	0.7	40
PAR1155	Chatter Bench	1'5" / -	5'3" x 1'4"	0.5	29
PAR1156	Chatter Bench with Backrest and Armrest	1'5" / -	5'3" x 1'8"	0.9	58
PAR3001	Bicycle Stand	- / -	0'9" x 0'2"	0.1	16
KPL205	Dustbin 60 L	- / -	1'9" x 1'2"	0.8	55



# LOOP

## Furniture for Indoor and Outdoor Use

The Loop family features an extensive range of modular elements perfect for indoor and outdoor use. At the heart of this range are infinite possibilities for creative and social interactions. Play or sit on, beside, and between for impromptu meetings or a break.

With sixteen modules in thirteen color options, this range is perfect for vibrant cityscapes, parks, schools, and recreational areas.



LOOP Circle  
TPP29500



LOOP Picnic 500  
TPP29620



LOOP Cone  
TPP29540



LOOP Arc  
TPP29510



LOOP Corner  
TPP29520



LOOP HopOp 500  
TPP29610



LOOP Line  
TPP29530



LOOP Boa  
TPP29660



LOOP HopOp 350/500  
TPP29600



LOOP Lava  
TPP29670

## PRODUCT INFORMATION

Product number	Product name	Height Seat/table ft & in	Product dimensions (ft & in x ft & in)	Installation (hours)	Total CO <sub>2</sub> e (kg CO <sub>2</sub> e)
TPP29500	LOOP Circle	1'4" / 0'0"	5'11" x 5'11"	-	-
TPP29620	LOOP Picnic 500	1'4" / 2'4"	82'0" x 73'6"	-	-
TPP29540	LOOP Cone	0'0" / 2'4"	3'11" x 3'11"	-	-
TPP29510	LOOP Arc	1'5" / 0'0"	4'3" x 6'4"	-	-
TPP29520	LOOP Corner	1'5" / 0'0"	4'7" x 4'7"	-	-
TPP29610	LOOP HopOp 500	1'4" / 0'0"	16'5" x 16'5"	-	-
TPP29530	LOOP Line	1'5" / 0'0"	1'4" x 6'7"	-	-
TPP29660	LOOP Boa	1'4" / 0'0"	39'4" x 78'9"	-	-
TPP29600	LOOP HopOp 350/500	1'10" / 0'0"	16'5" x 16'5"	-	-
TPP29670	LOOP Lava	1'8" / 0'0"	8'6" x 3'11"	-	-



# FLEXIBILITY

With a variety of colors and part options, we offer lots of flexibility and customization with our standard products.



Cone Planter



Circle with Backrest



Circle with Table



Arc Snake

# OPTIONS

Colors



Loop Tables



Cone Tops



Loop & Hopop Integrated Light



## More flexibility

Contact us for more information on the extended range of options for configurable outdoor furniture. Please note that prices and delivery terms depend on specified configurations.



# LOCAL SITES



↑ JOHN HUNT PARK  
Huntsville, Alabama, US



↑ STUYVESANT TOWN-PETER COOPER VILLAGE  
New York City, New York, US





↑ RIVER PINES ELEMENTARY SCHOOL  
Houston, Texas, US



← RESERVOIR PARK  
Harrisburg, Pennsylvania, US



↑ JERRY MATHESON PARK  
Houston, Texas, US





# FUNCTIONAL SAFE SURFACING

The choice of creative designers

**KOMPAN** provides high-quality wetpour surfacing solutions. From a safety perspective, this surfacing gives a brilliant shock absorption.

With multi-colored safe surfacing, designers can be very playful and the children love it!

Different colors, shapes, and graphics can support and highlight an overall de-

sign theme and also extend play from the equipment into the surface.

The soft yet firm surfacing is highly inclusive, making it possible for wheelchair users to easily access the playground. From an operational point of view, this type of surfacing provides a clean and comfortable surface with very low maintenance costs.



## ↑ CREATED FOR OUTDOOR FITNESS

Leveraging the surface to apply patterns for outdoor fitness significantly maximizes the training potential by offering more exercise opportunities.



## EMPHASIZE THE → ARCHITECTURAL EXPRESSION

of an area with surfacing available in multiple colors and several blends.



**RUBBER →  
GRAPHICS**

Different rubber graphics in 2D and 3D can emphasize a design theme and increase both play value and learning.





# COLOR OPTIONS

Multiple ways of customizing outdoor play and fitness solutions

## Hercules Rope colors

For rope used in play equipment, we offer eight different rope colors to choose from. The assortment is a wide span of colors ranging from elegant and expressive black or natural and toned-down sand color to a range of attractive and eye-catching signal colors. The ropes are made from >95% post-consumer recycled material.



Beige  
RAL 1002



Yellow  
RAL 1028



Orange  
RAL 2003



Red  
RAL 3020



Light blue  
RAL 5012



Medium blue  
RAL 5002



Green  
RAL 6028

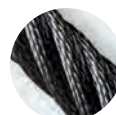

Black  
RAL 9005

## Robinia colors

For wooden Robinia play and fitness equipment, a variety of eight enjoyable colors in dusty and transparent shades are available to choose from.



Brown  
NCS S 3050-Y20R



Orange  
NCS S 2050-Y30R



Red  
NCS S 3050-Y90R



Green  
NCS S 3030-G40Y



Turquoise  
NCS S 4040-B30G



Blue  
NCS S 4030-B30G



Teal  
NCS S 6030-B90G



Gray  
NCS S 6502-B



Black  
NCS S 8500-N

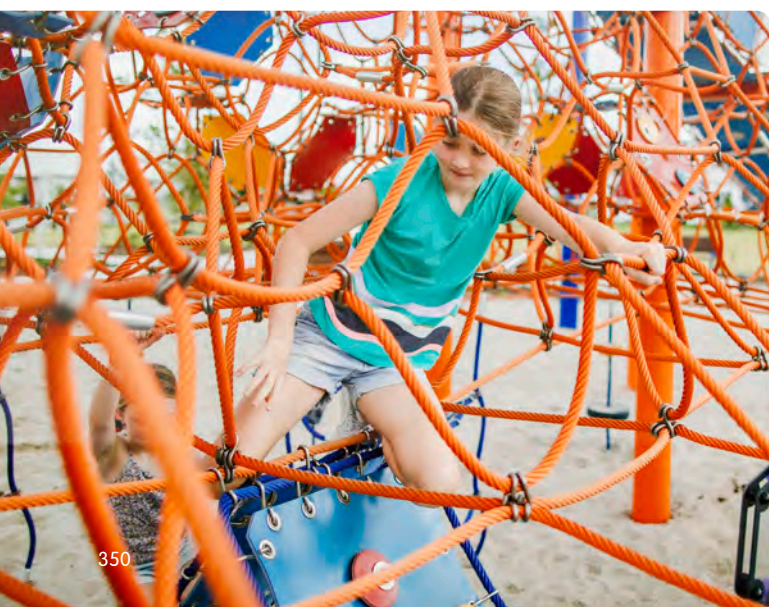

## Membrane colors

The popular membranes, which add lots of extra play value to the play structures, also come in optional colors. Choose between six different colors.



Yellow  
RAL 1006



Orange  
RAL 2010



Red  
RAL 3001



Blue  
RAL 5015



Medium green  
RAL 6029



Black\*  
RAL 9005

\* All membranes are available in black up to 78in wide. Colored membranes available up to 59in wide.



## EcoCore™

- Produced from >95% recycled material
- Recyclable after use
- Supported by our lifetime warranty



The 19mm EcoCore™ panels are made from a highly durable, eco-friendly material that is recyclable after use and produced from >95% post-consumer recycled material from e.g. food packaging waste.

### Colors

We offer a range of 14 different EcoCore™ HDPE panel colors. The assortment is a wide span of colors ranging from elegant and expressive black or natural and toned-down colors to attractive and eye-catching signal colors.

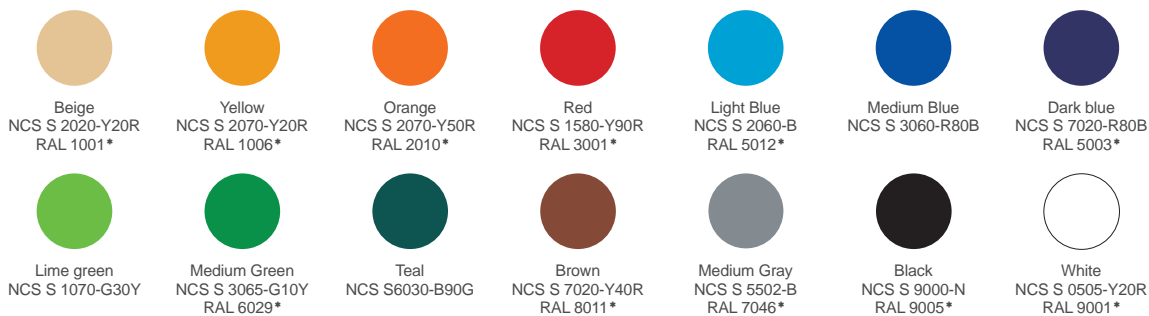

\* Color code value is approximate

## Steel colors

Distinct statements can be made with play or fitness structures adding special colors for the steel. 14 thrilling colors are offered in the standard assortment.

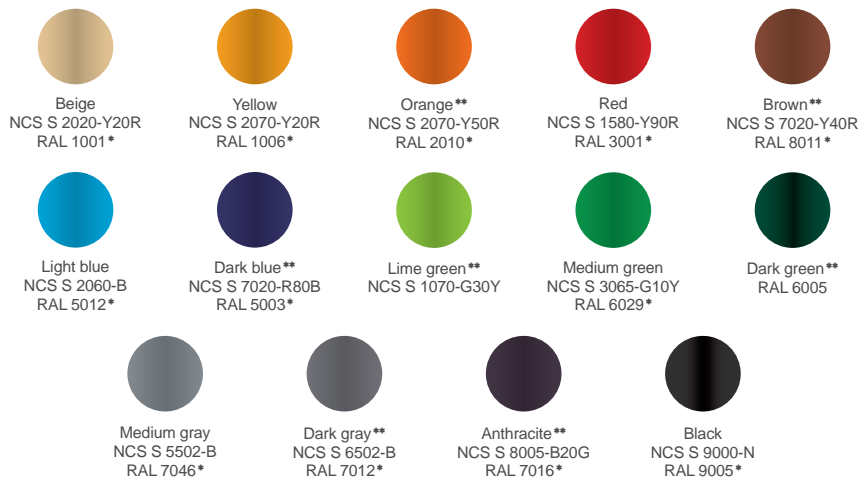

\* Color code value is approximate  
\*\* The color is available as matte or glossy

For exact colors of all materials, please refer to physical KOMPAN color samples.



# Index

Product number	Page	Product number	Page	Product number	Page	Product number	Page
BASIC550	153	COR36331	211	CRP812501	201	FRO102	310
BLX4101	134	COR36501	211	ELE400002	148	FRO104	311
BLX4102	134	COR37441	207	ELE400020	148	FRO105	310
BLX4103	134	COR39301	210	ELE400021	151	FRO201	311
BLX4104	134	COR39331	210	ELE400022	151	FRO202	311
BLX4105	134	COR39401	210	ELE400024	138 / 261	FRO203	311
BLX4106	134	COR39501	210	ELE400063	140	FRO209	311
COR101102	207	COR41421	212	ELE400064	138 / 261	FRO211	319
COR101202	207	COR41422	212	ELE400065	138 / 261	FRO212	319
COR10280	209	COR42401	212	ELE400067	148	FRO213	318
COR102902	207	COR43401	212	ELE400158	138	FRO214	319
COR10310	212	COR43481	212	ELE500008	138	FRO215	319
COR10320	182	COR45400	234	FAZ10101	302	FRO216	318
COR10330	183	COR46330	232	FAZ102	302	FRO218	318
COR10410	182	COR47330	233	FAZ103	302	FRO222	311
COR104202	208	COR48330	232	FAZ104	302	FST930	307
COR10430	184	COR49330	233	FAZ105	302	FSW101	306
COR10450	185	COR49480	234	FAZ10701	304	FSW102	306
COR10460	185	COR62140	230	FAZ108	304	FSW103	306
COR10470	182	COR63120	231	FAZ109	304	FSW104	306
COR10481	232	COR64120	230	FAZ20101	303	FSW105	306
COR10484	232	COR65090	230	FAZ20301	303	FSW201	309
COR10491	233	COR66120	230	FAZ20401	303	FSW202	309
COR10494	233	COR66900	195	FAZ20501	304	FSW203	309
COR10501	232	COR66910	195	FAZ20601	305	FSW204	309
COR10503	232	COR66920	195	FAZ207	305	FSW205	308
COR10511	233	COR68060	195	FAZ20801	305	FSW206	308
COR10513	233	COR71005	196	FAZ20901	305	FSW207	308
COR10521	234	COR71050	196	FAZ30100	309	FSW208	308
COR10524	234	COR71100	196	FAZ30101	309	FSW209	308
COR10535	197	COR71150	196	FAZ30200	309	FSW210	309
COR10545	197	COR71200	196	FAZ30201	309	FSW211	317
COR16102	188	COR86700	204	FAZ30300	309	FSW21201	316
COR16500	188	COR88100	205	FAZ30301	309	FSW213	316
COR17100	189	COR88200	205	FAZ30400	309	FSW214	317
COR17200	189	CRE86700	204	FAZ30401	309	FSW215	316
COR17300	189	CRP200102	216	FAZ50100	298	FSW216	316
COR17510	190	CRP200202	217	FAZ50101	298	FSW217	307
COR17520	190	CRP200302	216	FAZ50200	298	FSW218	317
COR17530	190	CRP200402	217	FAZ50201	298	FSW219	317
COR17600	191	CRP200502	216	FAZ51100	299	FSW220	308
COR17700	191	CRP200602	218	FAZ52100	299	FSW221	317
COR20100	228	CRP200702	218	FAZ52101	299	FSW222	313
COR20200	228	CRP200802	218	FAZ601	300	FSW223	312
COR20301	142 / 194	CRP200902	218	FAZ602	300	FSW224	312
COR20310	142 / 194	CRP201002	218	FAZ603	300	FSW225	312
COR20320	142 / 194	CRP201101	216	FAZ604	301	FSW226	312
COR20330	142 / 194	CRP201201	216	FAZ605	301	FSW227	313
COR20340	142 / 194	CRP250101	220	FAZ606	301	FSW228	313
COR20402	195	CRP250201	220	FAZ607	301	FSW229	313
COR20502	195	CRP250301	220	FRE2110	332	FSW230	313
COR20600	205	CRP250401	220	FRE2111	332	FSW231	312
COR20700	208	CRP250502	220	FRE2113	332	FSW236	314
COR21506	195	CRP250602	220	FRE2115	332	FSW237	314
COR22202	228	CRP250701	221	FRE2116	332	FSW238	307
COR22900	228	CRP250802	221	FRE2210	332	FSW301	307
COR23401	228	CRP250901	221	FRE2211	332	FSW302	307
COR24301	228	CRP251001	221	FRE2212	332	GXY8014	139
COR24501	228	CRP251101	222	FRE2213	332	GXY8015	139
COR294002	184	CRP251201	222	FRE3000	169	GXY8016	139
COR29600	184	CRP251301	222	FRE3010	169	GXY8019	144
COR29900	186	CRP251401	222	FRE3012	169	GXY901	130
COR29910	186	CRP251501	222	FRE3024	333	GXY902	130
COR29950	187	CRP251601	223	FRE3025	333	GXY903	130
COR29960	187	CRP251702	223	FRE3031	333	GXY919	144
COR30281	206	CRP251802	223	FRE3050	333	GXY934	144
COR30301	206	CRP251901	223	FRE3051	333	GXY935	144
COR30302	208	CRP252001	224	FRE3054	333	GXY939	130
COR30304	209	CRP252101	224	FRE600101	330	GXY941	130
COR31322	208	CRP252201	224	FRE600102	330	GXY943	131
COR31331	206	CRP252301	224	FRE600103	330	GXY944	140
COR31401	206	CRP252401	224	FRE600201	330	GXY949	131
COR31441	206	CRP411001	213	FRE600501	330	GXY950	131
COR31442	208	CRP800101	200	FRE600803	330	GXY957	141
COR31444	209	CRP800501	200	FRE601001	330	GXY958	141
COR32441	206	CRP810101	198	FRE601201	331	GXY959	140
COR32442	208	CRP810201	198	FRE601301	331	GXY960	140 / 261
COR33481	206	CRP811001	200	FRE601401	331	GXY961	130
COR34481	206	CRP811501	200	FRE601501	331	GXY962	130
COR35441	207	CRP812001	201	FRE601601	331	GXY963	130



Product number	Page	Product number	Page	Product number	Page	Product number	Page
GXY964	130	M529	155	NRO1020	244	NRO526	270
GXY965	131	M531	155	NRO1021	244	NRO528	270
GXY966	131	M534	155	NRO1022	243	NRO529	272
GXY967	131	M535	155	NRO1023	244	NRO533	271
GXY968	131	M536	154	NRO1024	244	NRO534	271
GXY970	139	M537	154	NRO1025	244	NRO535	271
KPL101	147	M584	153	NRO1026	245	NRO541	255
KPL102	147	M593	152	NRO104	260	NRO543	254
KPL103	147	M59305	273	NRO105	260	NRO545	255
KPL121	147	M620	159	NRO106	260	NRO547	254
KPL205	343	M631	160	NRO110	261	NRO549	255
KPL502	154	M63272	161	NRO111	260	NRO551	254
KPL503	153	M63273	161	NRO112	260	NRO560	256
KSW92001	172	M63274	161	NRO115	260	NRO561	256
KSW92003	172	M7000	156	NRO118	260	NRO562	256
KSW92005	172	M7021	156	NRO119	260	NRO563	256
KSW92007	172	M87201	167	NRO120	261	NRO564	256
KSW92008	172	M87202	167	NRO2006	244	NRO565	256
KSW92009	172	M87401	144	NRO2007	243	NRO602	269
KSW92011	172	M87402	144	NRO2008	245	NRO603	268
KSW921	173	M87403	144	NRO2009	245	NRO604	268
KSW9210	173	M88101	166	NRO2010	245	NRO605	268
KSW9212	173	M88102	166	NRO2012	245	NRO606	268
KSW922	173	M951	158	NRO2013	247	NRO610	268
KSW923	173	M984	175	NRO209	265	NRO611	268
KSW924	173	MSC5401	160	NRO212	269	NRO612	269
KSW925	173	MSC5402	78	NRO213	259	NRO613	269
KSW926	173	MSC540202	78	NRO215	259	NRO614	269
KSW928	173	MSC5404	161	NRO216	259	NRO615	269
KSW93014	176	MSC5406	160	NRO217	170 / 259	NRO616	269
KSW93040	176	MSC5407	159	NRO218	170 / 259	NRO805	265
KSW93045	176	MSC5408	160	NRO219	170 / 259	NRO806	265
KSW931	177	MSC5414	158	NRO3001	245	NRO808	265
KSW9310	177	MSC5415	158	NRO3002	243	NRO809	265
KSW9312	177	MSC5416	158	NRO3003	243	NRO810	265
KSW932	177	MSC5417	78	NRO4001	247	NRO811	265
KSW933	177	MSC541801	159	NRO401	242	NRO813	266
KSW934	177	MSC541803	159	NRO402	242	NRO815	266
KSW935	177	MSC5419	152	NRO404	242	NRO816	267
KSW936	177	MSC5420	159	NRO405	242	NRO817	266
KSW938	177	MSC542102	78	NRO407	242	NRO820	264
M101	146	MSC542103	79	NRO408	242	NRO826	266
M106	146	MSC5422	78	NRO409	242	NRO830	265
M113	146	MSC5424	78	NRO410	250	NRO831	266
M123	146	MSC5425	152	NRO411	250	NRO832	264
M128	148	MSC5426	82	NRO412	250	NRO833	266
M130	146	MSC5427	78	NRO413	250	NRO834	266
M143	150	MSC6407	80	NRO414	250	NRO836	266
M147	151	MSC6408	80	NRO415	250	NRO852	267
M165	147	MSC6410	80	NRO416	246	NRO854	264
M166	146	MSC6411	80	NRO417	246	NRO856	264
M168	147	MSC6416	81	NRO418	246	NRO857	264
M170	147	MSC6418	81	NRO421	252	NRO875	263
M171	147	MSC6419	81	NRO423	252	NRO877	263
M172	146	MSC6421	81	NRO425	252	NRO879	262
M173	148	MSC6422	81	NRO427	252	NRO881	263
M174	148	MSC6424	81	NRO429	252	NRO883	262
M175	148	MSC6430	82	NRO431	253	NRO884	261
M176	151	MSC6431	82	NRO501	272	NRO887	265
M177	148	MSC6434	83	NRO502	272	NRO888	265
M181	150	MSC6435	83	NRO503	272	NRO889	265
M182	150	MSV201	163	NRO504	270	NRO910	274
M183	150	MSV601	163	NRO505	270	NRO911	274
M186	151	MSV602	162	NRO506	272	NRO912	274
M187	151	MSV603	163	NRO507	272	NRO915	274
M188	158	MSV604	163	NRO508	272	NRO916	274
M189	158	MSV605	162	NRO509	272	NRO921	275
M191	158	MSV606	162	NRO510	270	NRO922	275
M230	161	NRC100401	239	NRO511	258	NRO923	275
M240	156	NRC200101	238	NRO513	258	NRO924	275
M241	154	NRC200201	239	NRO514	258	NRO925	275
M242	154	NRC200401	240	NRO515	259	NRO926	275
M243	156	NRC300101	240	NRO516	259	PAR1002	341
M259	159	NRC400101	240	NRO517	259	PAR1006	341
M26003	159	NRC60101	238	NRO518	259	PAR1009	341
M261	159	NRC60201	238	NRO519	258	PAR1011	341
M410	156	NRO101	260	NRO520	258	PAR1012	341
M411	156	NRO1018	243	NRO521	272	PAR1013	341
M525	155	NRO1019	243	NRO523	270	PAR1015	341
M526	155	NRO102	260	NRO524	273	PAR1016	341



Product number	Page	Product number	Page	Product number	Page	Product number	Page
PAR1019	341	PCE310231	122	PCM157	140	PCT111431	72
PAR1037	341	PCE310531	123	PCM160	138	PCT111731	74
PAR1038	341	PCE400231	119	PCM161	141	PCT111831	74
PAR1050	342	PCE405031	120	PCM200131	96	PCT210631	71
PAR1051	342	PCE405121	121	PCM200231	96	PCT210731	71
PAR1052	342	PCE410132	127	PCM200331	97	PCT210831	71
PAR1053	342	PCE50121	120	PCM200431	98	PCT801	75
PAR1054	342	PCE50221	120	PCM200531	90	PCT802	75
PAR1055	342	PCE50321	120	PCM200631	90	PCT803	75
PAR1059	342	PCE610331	123	PCM200831	92	PCT804	75
PAR1060	342	PCE610431	123	PCM201	169	PCX0001	108
PAR1062	342	PCM000121	160	PCM201031	92	PCX0002	108
PAR1151	343	PCM000321	79	PCM201231	93	PCX0003	108
PAR1152	343	PCM000421	79	PCM201331	93	PCX1001	108
PAR1155	343	PCM000521	79	PCM201831	84	PCX2001	108
PAR1156	343	PCM000621	164	PCM201931	97	PCX2101	110
PAR1403	342	PCM000721	164	PCM202	170	PCX2102	110
PAR1404	342	PCM0012	164	PCM202031	97	PCX3001	109
PAR1405	342	PCM0013	164	PCM202631	99	PCX3002	109
PAR3001	343	PCM001621	91	PCM203	170	PCX4101	111
PAR3003	170	PCM001821	91	PCM204	170	PCX5101	111
PAR3004	170	PCM002331	91	PCM211231	102	PCX701	110
PAR3005	170 / 303	PCM002431	91	PCM211331	102	PCX801	108
PAR4050	338	PCM002531	91	PCM211431	103	PCX802	110
PAR4051	338	PCM002921	161	PCM211931	104	PCX803	110
PAR4052	338	PCM003121	164	PCM212531	85	PCX804	110
PAR4058	338	PCM003221	164	PCM212731	103	SW990011	174
PAR4060	338	PCM003321	164	PCM212931	102	SW990023	174
PAR4061	338	PCM003421	164	PCM213031	102	SW990031	174
PAR4062	338	PCM003531	91	PCM300131	97	SW990091	174
PAR4063	338	PCM100131	96	PCM300531	90	SW990111	174
PAR4064	338	PCM100231	96	PCM300831	93	SW990131	174
PAR4070	340	PCM100331	96	PCM301131	98	SW990201	174
PAR4075	340	PCM100431	96	PCM301231	97	SW990205	174
PAR4080	340	PCM100831	98	PCM301331	98	TPP29500	344
PAR4083	340	PCM100931	98	PCM310331	104	TPP29510	344
PAR4170	340	PCM101031	90	PCM310431	104	TPP29520	344
PAR4180	340	PCM101231	90	PCM310531	103	TPP29530	344
PCE100131	118	PCM101431	92	PCM310631	105	TPP29540	344
PCE100331	118	PCM101531	92	PCM310731	105	TPP29600	344
PCE105131	120	PCM101631	92	PCM311231	105	TPP29610	344
PCE105221	120	PCM101731	92	PCM400131	97	TPP29620	344
PCE105431	120	PCM102631	86	PCM400231	93	TPP29660	344
PCE105532	126	PCM102721	86	PCM400531	90	TPP29670	344
PCE105632	126	PCM102931	84	PCM400831	84		
PCE105932	126	PCM103	147	PCM410231	104		
PCE110631	122	PCM103031	98	PCM410331	104		
PCE110731	122	PCM103231	86	PCM410731	84		
PCE110831	122	PCM103731	96	PCM501	153		
PCE110931	122	PCM103831	98	PCM502	153		
PCE111131	122	PCM103931	99	PCM503	153		
PCE111331	122	PCM104	147	PCM504	152		
PCE111432	128	PCM104031	99	PCM505	152		
PCE111532	128	PCM104131	99	PCM51131	88		
PCE111632	127	PCM104231	90	PCM51331	88		
PCE111732	127	PCM104331	96	PCM51531	88		
PCE112531	123	PCM104431	96	PCM516	155		
PCE200231	118	PCM104531	96	PCM610131	104		
PCE200431	118	PCM105	147	PCM701	168		
PCE200531	118	PCM106	147	PCM702	168		
PCE205031	120	PCM110121	102	PCM703	168		
PCE205131	120	PCM110221	102	PCM704	168		
PCE205221	120	PCM111531	103	PCM802	144		
PCE205531	120	PCM111631	103	PCM803	144		
PCE205621	121	PCM111731	105	PCM804	160		
PCE205732	126	PCM111831	105	PCM805	169		
PCE205832	126	PCM112131	102	PCM80621	145		
PCE210531	122	PCM112731	84	PCM80721	145		
PCE210631	122	PCM112931	84	PCM80821	145		
PCE210731	122	PCM113131	84	PCM80921	145		
PCE210932	128	PCM113331	86	PCM81021	145		
PCE211032	128	PCM113531	87	PCM81121	145		
PCE211132	127	PCM114031	85	PCM81221	145		
PCE211232	127	PCM114231	102	PCM81331	145		
PCE211731	123	PCM114431	166	PCM900131	92		
PCE211832	127	PCM114531	102	PCT110931	70		
PCE211932	128	PCM114631	102	PCT111031	70		
PCE212032	128	PCM114731	102	PCT111131	70		
PCE305021	121	PCM151	141	PCT111231	72		
PCE305121	121	PCM154	141 / 160	PCT111331	72		









**KOMPAN North America**  
Kompan, Inc.  
605 West Howard Lane, Suite 101  
Austin, TX 78753  
USA  
Tel.: 1-800-426-9788  
contact@kompan.com  
www.kompan.com



Sign up for the  
KOMPAN Newsletter

**OMNIA**  
PARTNERS



**Contract Holder**  
Contract # 47Q5MA20D08PD